

RED CHRIS OPERATIONS

BRITISH COLUMBIA, CANADA

NI 43-101 Technical Report

Report prepared for:

Newcrest Mining Limited
Imperial Metals Corporation

Qualified Persons:

Mr. Rob Stewart, FAusIMM.
Mr. Brett Swanson. MMSAQP.
Mr. Michael Sykes, FAusIMM.
Mr. Laurie Reemeyer, P.Eng.
Dr. Bing Wang, P.Eng.
Mr. Philip Stephenson, FAusIMM.

Effective Date:

30 June, 2021



CERTIFICATE OF QUALIFIED PERSON

Rob Stewart, FAusIMM
Newcrest Mining Limited
Level 8, 600 St Kilda Rd,
Melbourne, Victoria, 3004
Australia

I, Robert (“Rob”) Stewart, FAusIMM., am employed as the Group Manager Resources with Newcrest Mining Limited (“Newcrest”), situated at Level 8, 600 St Kilda Rd, Melbourne, Victoria, Australia.

This certificate applies to the technical report titled “Red Chris Operations, British Columbia, Canada, NI 43-101 Technical Report” that has an effective date of 30 June, 2021 (the “technical report”).

I am a Fellow of Australasian Institute of Mining and Metallurgy (FAusIMM); #109697. I graduated with a Bachelor of Applied Science in Applied Geology from the Royal Melbourne Institute of Technology in 1989.

I have practiced my profession for over 30 years since graduation. I have been directly involved in exploration, resource development, feasibility studies, geological evaluation, resource estimation, ore control, and reconciliations for both open pit and underground mining of gold ± silver ± copper deposits in Australia and Papua New Guinea.

As a result of my experience and qualifications, I am a Qualified Person as defined in National Instrument 43–101 *Standards of Disclosure for Mineral Projects* (NI 43–101) for those sections of the technical report that I am responsible for preparing.

I visited the Red Chris Operations from 4–11 April 2019, under the supervision of Jim Miller-Tait, P.Geol.

I am responsible for Sections 1.1, 1.2, 1.3, 1.4, 1.5, 1.6, 1.7, 1.8, 1.10, 1.11, 1.22, 1.24; Section 2; Section 4; Section 5; Section 6; Section 7; Section 8; Section 9; Section 10; Section 11; Section 12; Section 14; Section 23; Sections 25.1, 25.2, 25.3, 25.4, 25.6, 25.16; Sections 26.1, 26.2, 26.3.1; and Section 27 of the technical report.

I am not independent of Newcrest, as independence is described by Section 1.5 of NI 43–101. I am independent of Imperial Metals Corporation, as independence is described by Section 1.5 of NI 43–101.

I have been involved with the Red Chris Operations since 2019 in my role as Group Manager Resources providing governance of the data management, ore control, and reconciliation systems. I have also planned the resource development drilling and oversaw the development of the geological framework and resource estimations.

I have read NI 43–101 and the sections of the technical report for which I am responsible have been prepared in compliance with that Instrument.

As of the effective date of the technical report, to the best of my knowledge, information and belief, the sections of the technical report for which I am responsible contain all scientific and technical information that is required to be disclosed to make the technical report not misleading.

Dated: 29 November, 2021

“signed”

Robert (Rob) Stewart, FAusIMM.

CERTIFICATE OF QUALIFIED PERSON

Brett C. Swanson, MMSAQP
Newcrest Mining Limited
Level 8, 600 St Kilda Rd,
Melbourne, Victoria, 3004
Australia

I, Brett C. Swanson, MMSAQP, am employed as a Principal Open Pit Planning Engineer with Newcrest Mining Limited (Newcrest), situated at Level 8, 600 St Kilda Rd, Melbourne, Victoria, Australia.

This certificate applies to the technical report titled “Red Chris Operations, British Columbia, Canada, NI 43-101 Technical Report” that has an effective date of 30 June, 2021 (the “technical report”).

I am a Qualified Member of the Mining & Metallurgical Society of America (MMSAQP), #01418QP. I graduated with a Bachelor of Engineering in Mining Engineering degree from the University of Wollongong in 1995.

I have practiced my profession for 26 years. My relevant experience includes contributions to mine operations, feasibility, pre-feasibility, preliminary assessment and competent person reports with a focus on open pit mine planning and reserve reporting.

As a result of my experience and qualifications, I am a Qualified Person as defined in National Instrument 43–101 *Standards of Disclosure for Mineral Projects* (NI 43–101) for those sections of the technical report that I am responsible for preparing.

I have not visited the Red Chris Operations.

I am responsible for Sections 1.1, 1.2, 1.12.1, 1.13, 1.14.1, 1.14.3, 1.16.1, 1.19.1, 1.20.1 1.22; Section 2.1, 2.2, 2.3, 2.5, 2.6; Sections 15.1, 15.2, 15.4, 15.5, 15.6; Sections 16.1.1, 16.2, 16.4.1, 16.4.3, 16.5, Sections 18.3, 18.4, 18.15; Section 21.1, Section 21.2.1, 21.2.3, 21.3.1, 21.3.3, 21.4; Section 25.1, 25.7, 25.8, 25.14, 25.16, and 25.17; and Section 27 of the technical report.

I am not independent of Newcrest, as independence is described by Section 1.5 of NI 43–101. I am independent of Imperial Metals Corporation, as independence is described by Section 1.5 of NI 43–101.

I have been involved with the Red Chris Operations since 2019 as a long-term planning engineer.

I have read NI 43–101 and the sections of the technical report for which I am responsible have been prepared in compliance with that Instrument.

As of the effective date of the technical report, to the best of my knowledge, information and belief, the sections of the technical report for which I am responsible contain all scientific and technical information that is required to be disclosed to make the technical report not misleading.

Dated: 29 November, 2021

“signed”

Brett C. Swanson, MMSAQP.

CERTIFICATE OF QUALIFIED PERSON

Michael Sykes, FAusIMM
Newcrest Mining Limited
Level 8, 600 St Kilda Rd,
Melbourne, Victoria, 3004
Australia

I, Michael Sykes, FAusIMM, am employed as a Mining Study Manager with Newcrest Mining Limited (“Newcrest”), situated at Level 8, 600 St Kilda Rd, Melbourne, Victoria, Australia.

This certificate applies to the technical report titled “Red Chris Operations, British Columbia, Canada, NI 43-101 Technical Report” that has an effective date of 30 June, 2021 (the “technical report”).

I am a Fellow of Australasian Institute of Mining and Metallurgy (FAusIMM, #206478). I graduated from University of Ballarat, with a Bachelor of Engineering (Mining, Hons) in 2001.

I have practiced my profession for 20 years. Throughout the 20 years I have been directly involved in planning and development of underground mines that used a variety of mining methods. A significant portion of the last eight years has had a focus on designing and planning block cave projects in various locations globally.

As a result of my experience and qualifications, I am a Qualified Person as defined in National Instrument 43–101 *Standards of Disclosure for Mineral Projects* (NI 43–101) for those sections of the technical report that I am responsible for preparing.

I visited the Red Chris Operations from 16–19 November, 2019, under the supervision of Laurie Reemeyer, P.Eng.

I am responsible for Sections 1.1, 1.2, 1.12.2, 1.13, 1.14.2, 1.14.3, 1.16.1, 1.16.4, 1.16.5, 1.17, 1.18.2, 1.19.2, 1.20.2, 1.21, 1.22, 1.23, 1.24; Sections 2.1, 2.2, 2.3, 2.4, 2.5, 2.6; Section 3; Sections 15.1, 15.3, 15.4, 15.5, 15.6; Sections 16.1.2, 16.3, 16.4, 16.5; Sections 18.1, 18.2, 18.8, 18.9, 18.10, 18.11, 18.12, 18.13, 18.14, 18.15; Sections 19.2, 19.3; Section 20, Section 21.1, 21.2.2, 21.2.3, 21.3.2, 21.3.3, 21.4; Section 22; Section 24; Sections 25.1, 25.7, 25.8, 25.10, 25.11, 25.12, 25.13, 25.14, 25.15, 25.16, 25.17; Sections 26.1, 26.3.2, 26.3.5, 26.3.6, 26.3.7; and Section 27 of the technical report.

I am not independent of Newcrest, as independence is described by Section 1.5 of NI 43–101. I am independent of Imperial Metals Corporation, as independence is described by Section 1.5 of NI 43–101.

I have been involved with the Red Chris Operations since 2019, in my role as the Mining Lead – Red Chris Block Cave Project.

I have read NI 43–101 and the sections of the technical report for which I am responsible have been prepared in compliance with that Instrument.

As of the effective date of the technical report, to the best of my knowledge, information and belief, the sections of the technical report for which I am responsible contain all scientific and technical information that is required to be disclosed to make the technical report not misleading.

Dated: 29 November, 2021

“signed”

Michael Sykes, FAusIMM

CERTIFICATE OF QUALIFIED PERSON

Laurie Reemeyer, P.Eng.
Newcrest Mining Limited
Level 8, 600 St Kilda Rd,
Melbourne, Victoria, 3004
Australia

I, Hendrik Cornelis Laurens (Laurie) Reemeyer, P.Eng., am employed as a consultant with Newcrest Mining Limited (Newcrest), situated at Level 8, 600 St Kilda Rd, Melbourne, Victoria, Australia.

This certificate applies to the technical report titled “Red Chris Operations, British Columbia, Canada, NI 43-101 Technical Report” that has an effective date of 30 June, 2021 (the “technical report”).

I am a Member of the Association of Professional Engineers and Geoscientists of British Columbia, (#43997), and a Fellow of the Australasian Institute of Mining and Metallurgy, (#110005). I graduated from the University of Queensland in 1993 with a Bachelor of Engineering (Minerals Process) degree, and from the University of California at Berkeley in 2010 with a Masters of Business Administration degree.

I have practiced my profession for 28 years. I have research, operations and consulting experience in base and precious metals processing. This has included plant and project metallurgist roles at Mount Isa Mines Copper Concentrator and Copper Smelter, process and tailings due diligence on copper–gold porphyry operations and projects in Australia, Asia and North and South America, and study lead for the Oyu Tolgoi 2013 feasibility study update.

As a result of my experience and qualifications, I am a Qualified Person as defined in National Instrument 43–101 *Standards of Disclosure for Mineral Projects* (NI 43–101) for those sections of the technical report that I am responsible for preparing.

I visited the Red Chris Operations from 14–20 September, 2021.

I am responsible for Sections 1.1, 1.2, 1.9, 1.15, 1.18.1, 1.22, 1.24; Sections 2.1 to 2.4, 2.6; Section 13; Section 17; Sections 19.1, 19.4; Sections 25.1, 25.5, 25.9, 25.12; Sections 26.1, 26.3.3; and Section 27 of the technical report.

I am not independent of Newcrest, as independence is described by Section 1.5 of NI 43–101. I am independent of Imperial Metals Corporation, as independence is described by Section 1.5 of NI 43–101.

I have been involved with the Red Chris Operations since 2019 in roles including Red Chris Block Cave Concept Study Manager and subsequently, Process and Tailings Lead – Red Chris Block Cave Project.

I have read NI 43–101 and the sections of the technical report for which I am responsible have been prepared in compliance with that Instrument.

As of the effective date of the technical report, to the best of my knowledge, information and belief, the sections of the technical report for which I am responsible contain all scientific and technical information that is required to be disclosed to make the technical report not misleading.

Dated: 29 November 2021.

“signed”

Laurie Reemeyer, P.Eng.

CERTIFICATE OF QUALIFIED PERSON

Dr. Bing W. Wang, P.Eng.
Newcrest Mining Limited
Highway 37,
PO Box 310, Dease Lake,
British Columbia, V0C 1L0, Canada

I, Dr. Bing W. Wang, P.Eng., am employed as the Tailings Operation Manager at Red Chris Mine with Newcrest Mining Limited (Newcrest), situated at Highway 37, PO Box 310, Dease Lake, British Columbia, V0C 1L0, Canada.

This certificate applies to the technical report titled “Red Chris Operations, British Columbia, Canada, NI 43-101 Technical Report” that has an effective date of 30 June, 2021 (the “technical report”).

I am a Professional Engineer with Engineers and Geoscientists British Columbia (Licence No.: 31203). I graduated from McGill University, Montreal, Canada, with Master of Engineering and Doctor of Philosophy degrees in 1984 and 1990, respectively.

I have practiced my profession for 36 years since graduation. I have been directly involved in field of geo-environmental engineering with site investigations, scoping, prefeasibility and feasibility studies, detailed design and construction for tailings and water management facilities, including geotechnical assessments and implementations for mining projects in Canada and worldwide.

As a result of my experience and qualifications, I am a Qualified Person as defined in National Instrument 43–101 *Standards of Disclosure for Mineral Projects* (NI 43–101) for those sections of the technical report that I am responsible for preparing.

I am directly employed at the Red Chris Operations and work a week-on-week-off roster. This familiarity with the operations serves as my personal inspection for the purposes of the technical report.

I am responsible for Sections 1.1, 1.2, 1.16.2, 1.16.3, 1.22, 1.24; Sections 2.1 to 2.4, 2.6; Sections 18.5, 18.6, 18.7; Sections 25.1, 25.10, 25.16; Sections 26.1, 26.3.4; and Section 27 of the technical report.

I am not independent of Newcrest, as independence is described by Section 1.5 of NI 43–101.

I have worked for Newcrest since 7 December 2020 and has been based at Red Chris Mine as a Responsible Tailings Facility Engineer since that time to the technical report effective date. I have held the role of Tailings Operation Manager and have the overall responsibility for the planning and execution of annual tailings dams raising construction, tailings and reclaim ponds operation, seepage control and water management in consultation with the Engineer of Record, as well as budgeting preparation. I also facilitate the Independent Engineering Review Panel review work in liaison with Newcrest’s Head of Tailings.

I have read NI 43–101 and the sections of the technical report for which I am responsible have been prepared in compliance with that Instrument.

As of the effective date of the technical report, to the best of my knowledge, information and belief, the sections of the technical report for which I am responsible contain all scientific and technical information that is required to be disclosed to make the technical report not misleading.

Dated: 29 November 2021.

“signed and sealed”.

Dr. Bing W. Wang, P.Eng.

CERTIFICATE OF QUALIFIED PERSON

Philip Stephenson, FAusIMM
Newcrest Mining Limited
Level 8, 600 St Kilda Rd,
Melbourne, Victoria, 3004
Australia

I, Philip Stephenson, FAusIMM am employed as the Chief Operating Officer, Australia and Americas, with Newcrest Mining Limited (Newcrest), situated at Level 8, 600 St Kilda Rd, Melbourne, Victoria, Australia.

This certificate applies to the technical report titled “Red Chris Operations, British Columbia, Canada, NI 43-101 Technical Report” that has an effective date of 30 June, 2021 (the “technical report”).

I am a Fellow of the Australasian Institute of Mining and Metallurgy (FAusIMM, #112873). I graduated from James Cook University in North Queensland in 1987 with a Bachelor of Science degree, and from LaTrobe University, Victoria, with a Graduate Diploma of Mineral Processing Technology.

I have practiced my profession for 34 years. I have been involved in mine site management in Australia and Papua New Guinea, and have held executive management roles for business units in Australasia, West Africa, Indonesia and Canada. I have also been involved in development roles in corporate health, safety and environment, security, business improvement and project management.

As a result of my experience and qualifications, I am a Qualified Person as defined in National Instrument 43–101 *Standards of Disclosure for Mineral Projects* (NI 43–101) for those sections of the technical report that I am responsible for preparing.

I visited the Red Chris Operations most recently from 18–23 November, 2021, under the supervision of Mr. Benjamin David, P.Eng.

I am responsible for Sections 1.1, 1.2, 1.22; Sections 2.1, 2.2, 2.3, 2.4, 2.6; Section 3; Sections 25.1, 25.16; and Section 27 of the technical report.

I am not independent of Newcrest, as independence is described by Section 1.5 of NI 43–101. I am independent of Imperial Metals Corporation, as independence is described by Section 1.5 of NI 43–101.

I have been involved with the Red Chris Operations since March 2019 as the Integration Sponsor for the acquisition, and from August 2019 as the Chief Operating Officer –

Australia & America (Red Chris is one of three operations that fall under my remit in this role).

I have read NI 43–101 and the sections of the technical report for which I am responsible have been prepared in compliance with that Instrument.

As of the effective date of the technical report, to the best of my knowledge, information and belief, the sections of the technical report for which I am responsible contain all scientific and technical information that is required to be disclosed to make the technical report not misleading.

Dated: 29 November, 2021

“signed”

Philip Stephenson FAusIMM.

CONTENTS

1	SUMMARY	1
1.1	Introduction	1
1.2	Terms of Reference	1
1.3	Project Setting	2
1.4	Mineral Tenure, Surface Rights, Water Rights, Royalties and Agreements	2
1.5	Geology and Mineralization	3
1.6	History	3
1.7	Drilling and Sampling	4
1.8	Data Verification	6
1.9	Metallurgical Testwork	6
1.9.1	Open Pit	6
1.9.2	Block Cave Underground	7
1.10	Mineral Resource Estimation	8
1.11	Mineral Resource Statement	11
1.12	Mineral Reserve Estimation	11
1.12.1	Open Pit	11
1.12.2	Block Cave Underground	13
1.13	Mineral Reserve Statement	13
1.14	Mining Methods	15
1.14.1	Open Pit	15
1.14.2	Block Cave Underground	16
1.14.3	Production Schedule	17
1.15	Recovery Methods	17
1.15.1	Current Plant	18
1.15.2	Plant Requirements, Block Cave Underground	18
1.16	Project Infrastructure	19
1.16.1	Infrastructure	19
1.16.2	Tailings Impoundment Area	20
1.16.3	Water Management and Supply	21
1.16.4	Camps and Accommodation	21
1.16.5	Power and Electrical	21
1.17	Environmental, Permitting and Social Considerations	22
1.17.1	Environmental Considerations	22
1.17.2	Closure and Reclamation Planning	22
1.17.3	Permitting Considerations	23
1.17.4	Social Considerations	24
1.18	Markets and Contracts	24
1.18.1	Markets	24
1.18.2	Metal Price and Contract Assumptions	24
1.19	Capital Cost Estimates	25
1.19.1	Open Pit	25

1.19.2	Block Cave Underground.....	25
1.20	Operating Cost Estimates.....	26
1.20.1	Open Pit.....	26
1.20.2	Block Cave Underground.....	26
1.21	Economic Analysis.....	28
1.21.1	Forward-Looking Statements	28
1.21.2	Methodology Used.....	28
1.21.3	Cashflow Results	29
1.21.4	Sensitivity Analysis	29
1.22	Risks and Opportunities.....	30
1.22.1	Risks	30
1.22.2	Opportunities	33
1.23	Interpretation and Conclusions.....	33
1.24	Recommendations.....	33
2	INTRODUCTION	36
2.1	Introduction	36
2.2	Terms of Reference	36
2.3	Qualified Persons	38
2.4	Site Visits and Scope of Personal Inspection.....	38
2.5	Effective Dates.....	39
2.6	Information Sources and References.....	39
2.7	Previous Technical Reports.....	40
3	RELIANCE ON OTHER EXPERTS.....	42
4	PROPERTY DESCRIPTION AND LOCATION	43
4.1	Introduction	43
4.2	Property and Title in British Columbia	43
4.2.1	Mineral Title	43
4.2.2	Surface Rights	44
4.2.3	Environmental Regulations.....	45
4.2.4	Water Regulations	45
4.2.5	Royalties	45
4.2.6	Indigenous Peoples	46
4.2.7	Fraser Institute Survey.....	46
4.3	Project Ownership	46
4.4	Mineral Tenure.....	46
4.5	Surface Rights	47
4.6	Water Rights	54
4.7	Royalties and Encumbrances	54
4.8	Property Agreements.....	54
4.9	Permitting Considerations.....	54
4.10	Environmental Considerations.....	54
4.11	Social License Considerations	55
4.12	QP Comments on “Item 4; Property Description and Location”	55

5	ACCESSIBILITY, CLIMATE, LOCAL RESOURCES, INFRASTRUCTURE, AND PHYSIOGRAPHY	56
5.1	Accessibility	56
5.2	Climate	56
5.3	Local Resources and Infrastructure	56
5.4	Physiography	56
5.5	Tahltan Nation	57
5.6	Land Usage	57
5.7	QP Comments on “Item 5; Accessibility, Climate, Local Resources, Infrastructure, And Physiography”	58
6	HISTORY	59
6.1	Exploration History	59
6.2	Production History	59
7	GEOLOGICAL SETTING AND MINERALIZATION	62
7.1	Regional Geology	62
7.2	Project Geology	62
7.2.1	Lithologies	62
7.2.2	Metamorphism	65
7.2.3	Structure	65
7.2.4	Weathering	65
7.3	Local and Deposit Geology	65
7.3.1	Lithologies	65
7.3.2	Oxidation	68
7.3.3	Structure	68
7.3.4	Alteration	68
7.3.5	Mineralization	69
7.4	Prospects/Exploration Targets	73
7.5	QP Comments on “Item 7: Geological Setting and Mineralization”	73
8	DEPOSIT TYPES	74
8.1	Overview	74
8.2	Porphyry Copper Deposits	74
8.3	Red Chris	76
8.4	QP Comments on “Item 8: Deposit Types”	77
9	EXPLORATION	78
9.1	Grids and Surveys	78
9.2	Geological Mapping	78
9.3	Geochemical Sampling	78
9.3.1	Legacy	78
9.3.2	Imperial	78
9.3.3	Newcrest	78
9.4	Geophysics	80
9.4.1	Legacy	80
9.4.2	Imperial	80
9.4.3	Newcrest	80

9.5	Petrology, Mineralogy, and Research Studies	80
9.6	Exploration Potential.....	82
9.6.1	Red Chris.....	82
9.6.2	Regional Prospects.....	84
9.7	QP Comments on “Item 9: Exploration”	85
10	DRILLING	86
10.1	Introduction	86
10.2	Drill Methods.....	86
10.3	Logging Procedures.....	86
10.3.1	Legacy	86
10.3.2	Imperial	86
10.3.3	Newcrest.....	90
10.4	Recoveries.....	90
10.5	Collar Surveys	91
10.5.1	Legacy	91
10.5.2	Imperial	91
10.5.3	Newcrest.....	91
10.6	Downhole Surveys.....	91
10.6.1	Legacy	91
10.6.2	Imperial	91
10.6.3	Newcrest.....	91
10.7	Geotechnical and Hydrological Drilling.....	92
10.8	Grade Control	92
10.9	Drilling Completed Since Close-out Date for Database Supporting Mineral Resource Estimate	92
10.10	Sample Length/True Thickness	93
10.11	QP Comments on “Item 10: Drilling”.....	93
11	SAMPLE PREPARATION, ANALYSES, AND SECURITY	94
11.1	Sampling Methods.....	94
11.1.1	Core Sampling	94
	11.1.1.1 Legacy	94
	11.1.1.2 Imperial.....	94
	11.1.1.3 Newcrest.....	95
11.1.2	Ore Control (Blasthole) Sampling.....	95
11.2	Density Determinations.....	95
11.3	Analytical and Test Laboratories	96
11.4	Sample Preparation	96
11.5	Sample Analysis	97
11.6	Quality Assurance and Quality Control.....	97
11.6.1	Legacy	97
11.6.2	Imperial	97
11.6.3	Newcrest.....	98
11.7	Databases.....	100
11.8	Sample Security.....	100

11.9	Sample Storage	101
11.10	QP Comments on “Item 11: Sample Preparation, Analyses, and Security”	101
12	DATA VERIFICATION	103
12.1	Internal Data Verification	103
12.1.1	Data Verification at Newcrest 2019 Acquisition	103
12.1.2	Database	103
12.1.3	QA/QC	103
12.2	Data Verification by Qualified Person	103
12.3	Resources and Reserves Steering Committee	103
12.4	External Data Verification	104
12.5	QP Comments on “Item 12: Data Verification”	104
13	MINERAL PROCESSING AND METALLURGICAL TESTING	105
13.1	Introduction	105
13.2	Testwork Programs	105
13.3	Open Pit Testwork	105
13.4	Underground Block Cave Testwork	107
13.4.1	Sample Selection	107
13.4.2	Testwork Conducted	109
13.4.3	Mineralogy	110
13.4.4	Comminution	111
13.4.5	Recovery Circuit	112
	13.4.5.1 Rougher Flotation	112
	13.4.5.2 Regrind	114
	13.4.5.3 Cleaner Flotation	114
13.4.6	Dewatering	114
13.4.7	Environmental Considerations Regarding Tailings from Process Plant	115
13.5	Recovery Forecasts	116
13.5.1	Open Pit	116
13.5.2	Underground	116
	13.5.2.1 Copper	116
	13.5.2.2 Gold	116
	13.5.2.3 Silver	117
13.6	Metallurgical Variability	117
13.7	Concentrate Quality	117
13.8	Deleterious Elements	118
13.9	QP Comments on “Item 13: Mineral Processing and Metallurgical Testwork”	118
14	MINERAL RESOURCE ESTIMATES	120
14.1	Introduction	120
14.2	Modelling Approach	120
14.3	Exploratory Data Analysis	121
14.4	Density (Specific Gravity) Assignment	121
14.5	Grade Capping/Outlier Restrictions	121
14.6	Composites	121

14.7	Variography	122
14.8	Quantitative Kriging Neighbourhood Analysis	123
14.9	Estimation/Interpolation Methods	123
14.10	Block Model Validation	124
14.11	Classification of Mineral Resources	124
14.12	Reasonable Prospects of Eventual Economic Extraction	124
14.13	Mineral Resource Statement	126
14.14	Factors That May Affect the Mineral Resource Estimate	126
14.15	QP Comments on “Item 14: Mineral Resource Estimates”	129
15	MINERAL RESERVE ESTIMATES	130
15.1	Introduction	130
15.2	Open Pit	130
15.2.1	Optimization	130
15.2.2	Model Coding	130
15.2.3	Cut-off	130
15.2.4	Dilution and Ore Loss	130
15.3	Block Cave Underground	131
15.3.1	Development of Mining Case	131
15.3.2	Shut-off Values	132
15.3.3	Dilution	132
15.3.4	Input Values	132
15.4	Mineral Reserves Statement	133
15.5	Factors that May Affect the Mineral Reserves	133
15.6	QP Comments on “Item 15: Mineral Reserve Estimates”	135
16	MINING METHODS	136
16.1	Overview	136
16.1.1	Open Pit	136
16.1.2	Block Cave	136
16.2	Open Pit	136
16.2.1	Geotechnical Considerations	136
16.2.2	Hydrological Considerations	137
16.2.3	Pit Optimization	138
16.2.4	Pit Designs	138
16.2.5	Operations	140
16.2.6	Stockpiles	140
16.2.7	Waste Rock Storage Facilities	141
16.2.8	Equipment	141
16.3	Block Cave Underground	141
16.3.1	Geotechnical Considerations	141
16.3.1.1	Seismic Hazard Potential	141
16.3.1.2	Rock Mass Characterisation	143
16.3.1.3	Rock Mass Domains	143
16.3.1.4	Pre-Conditioning and Fragmentation	143

16.3.1.5	FLAC3D Modelling.....	144
16.3.1.6	Ground Support and Reinforcement.....	146
16.3.1.7	Inrush.....	146
16.3.1.8	Monitoring.....	146
16.3.2	Hydrogeological Considerations.....	147
16.3.3	Design Considerations.....	148
16.3.4	Mine Design.....	148
16.3.4.1	Declines.....	148
16.3.4.2	Primary Mine Design Parameters.....	151
16.3.4.3	Extraction Levels.....	151
16.3.4.4	Undercut Levels.....	151
16.3.4.5	Production Sequence.....	154
16.3.5	Materials Handling System.....	155
16.3.6	Ventilation.....	156
16.3.7	Heating.....	157
16.3.8	Waste Disposal.....	157
16.3.9	Underground Infrastructure.....	158
16.3.10	Equipment.....	158
16.4	Production Schedule.....	158
16.4.1	Open Pit.....	158
16.4.2	Block Cave Underground.....	158
16.4.3	Combined Open Pit and Underground.....	158
16.5	QP Comments on “Item 16: Mining Methods”.....	162
17	RECOVERY METHODS.....	163
17.1	Introduction.....	163
17.2	Plant Design.....	163
17.3	2021 PFS Process Alternatives Options.....	164
17.4	Central Case.....	166
17.4.1	Background.....	166
17.4.2	Plant Design.....	166
17.4.3	Process Flowsheet.....	169
17.4.4	Design Criteria.....	169
17.5	Upside Case Alternative.....	169
17.5.1	Background.....	169
17.5.2	Plant Design.....	175
17.5.3	Process Flowsheet.....	175
17.5.4	Design Criteria.....	175
17.6	Concentrate Shipping.....	180
17.7	Energy, Water, and Process Materials Requirements.....	180
17.7.1	Energy.....	180
17.7.2	Water.....	180
17.7.3	Process Consumables.....	180
17.8	QP Comments on “Item 17: Recovery Methods”.....	180

18	PROJECT INFRASTRUCTURE	182
18.1	Introduction	182
18.2	Road and Logistics	184
18.2.1	Roads.....	184
18.2.2	Logistics	184
18.3	Stockpiles	184
18.4	Waste Rock Storage Facilities.....	187
18.5	Tailings Storage Facilities.....	187
18.5.1	Existing Facility	187
18.5.2	Setting.....	187
18.5.3	Facility Expansion.....	188
	18.5.3.1 Designs.....	188
	18.5.3.2 Closure Considerations	189
18.5.4	Tailings Deposition Plan and Dam Raise Schedule	189
18.5.5	Tailings Pipelines and Pumping	192
18.6	Water Supply	193
18.6.1	Process Water Supply	193
18.6.2	TIA	193
18.6.3	Reclaim Dams	193
18.6.4	Potable Water	194
18.6.5	Water-Related Infrastructure	194
18.7	Water Management	194
18.8	Buildings and Laydown Infrastructure	195
18.9	Camps and Accommodation	195
18.10	Shotcrete/Concrete Supply.....	196
18.11	Power and Electrical	196
18.11.1	Existing Supply	196
18.11.2	2021 PFS Requirements	196
18.12	Fuel.....	197
18.13	Air Supply	197
18.14	Communications.....	197
18.15	QP Comments on “Item 18: Project Infrastructure”	197
19	MARKET STUDIES AND CONTRACTS	198
19.1	Market Studies	198
19.1.1	Introduction	198
19.1.2	Concentrate Production Forecast.....	199
19.1.3	Smelter Terms	200
19.1.4	Copper Payment Terms.....	200
	19.1.4.1 Copper Treatment and Copper Refining Charges.....	201
	19.1.4.2 Copper Concentrate Precious Metal Terms and Refining Charges	201
	19.1.4.3 Deleterious Elements	201
	19.1.4.4 Payment Terms	203
	19.1.4.5 Red Chris Concentrate Specification.....	203

19.2	Commodity Price Projections.....	203
19.3	Contracts.....	203
19.4	QP Comments on “Item 19: Market Studies and Contracts”	204
20	ENVIRONMENTAL STUDIES, PERMITTING, AND SOCIAL OR COMMUNITY IMPACT	206
20.1	Introduction	206
20.2	Baseline and Supporting Studies	206
20.3	Environmental Considerations/Monitoring Programs	207
20.4	Closure Plan	208
20.5	Permitting.....	208
20.5.1	Current Permit Status	208
20.5.2	2021 PFS Permit Requirements	210
20.5.2.1	Environmental Permitting	210
20.5.2.2	Permit Plan	211
20.5.2.3	Exploration Decline.....	211
20.5.2.4	Access and Conveyor Declines.....	211
20.5.2.5	Preconditioning, Large Excavations and Underground Development.....	212
20.5.2.6	MB1	212
20.5.2.7	MB2 and MB3.....	212
20.6	Considerations of Social and Community Impacts.....	212
20.7	QP Comments on “Item 20: Environmental Studies, Permitting, and Social or Community Impacts”	213
21	CAPITAL AND OPERATING COSTS	214
21.1	Introduction	214
21.2	Capital Cost Estimates	214
21.2.1	Open Pit.....	214
21.2.1.1	Basis of Estimate.....	214
21.2.1.2	Sustaining Cost Estimate	214
21.2.1.3	Processing Cost Estimate	214
21.2.1.4	General and Administration Cost Estimate	214
21.2.1.5	Mining Cost Estimate.....	214
21.2.2	Block Cave Underground.....	214
21.2.2.1	Basis of Estimate.....	215
21.2.2.2	Labour Assumptions	215
21.2.2.3	Equipment and Materials.....	216
21.2.2.4	Quantities.....	216
21.2.2.5	Indirect Costs.....	216
21.2.2.6	Owner’s Costs	217
21.2.2.7	Contingency.....	217
21.2.3	Capital Cost Summary.....	217
21.3	Operating Cost Estimates.....	218
21.3.1	Open Pit.....	218
21.3.1.1	Basis of Estimate.....	218
21.3.2	Block Cave Underground.....	219

21.3.2.1	Basis of Estimate	219
21.3.2.2	Mine Operating Costs	220
21.3.2.3	Process Operating Costs	220
21.3.2.4	Tailings	221
21.3.2.5	Infrastructure Operating Costs	221
21.3.2.6	General and Administrative Operating Costs	221
21.3.3	Operating Cost Summary	222
21.4	QP Comments on “Item 21: Capital and Operating Costs”	222
22	ECONOMIC ANALYSIS	224
22.1	Forward-Looking Statements	224
22.2	Methodology Used	224
22.3	Financial Model Parameters	224
22.3.1	Mineral Reserves and Mine Life	224
22.3.2	Metallurgical Recoveries	225
22.3.3	Smelting and Refining Terms	225
22.3.4	Metal Prices	225
22.3.5	Capital and Operating Costs	225
22.3.6	Royalties	225
22.3.7	Working Capital	225
22.3.8	Taxes	225
22.3.9	Closure Costs and Salvage Value	227
22.3.10	Financing	227
22.3.11	Inflation	227
22.4	Financial Analysis	227
22.5	Sensitivity Analysis	236
22.6	QP Comments on “Item 22: Economic Analysis”	238
23	ADJACENT PROPERTIES	239
24	OTHER RELEVANT DATA AND INFORMATION	240
25	INTERPRETATION AND CONCLUSIONS	241
25.1	Introduction	241
25.2	Mineral Tenure, Surface Rights, Water Rights, Royalties and Agreements	241
25.3	Geology and Mineralization	241
25.4	Exploration, Drilling and Analytical Data Collection in Support of Mineral Resource Estimation	242
25.5	Metallurgical Testwork	242
25.6	Mineral Resource Estimates	243
25.7	Mineral Reserve Estimates	243
25.8	Mine Plan	244
25.9	Recovery Plan	245
25.10	Infrastructure	246
25.11	Environmental, Permitting and Social Considerations	247
25.12	Markets and Contracts	248
25.13	Capital Cost Estimates	248

25.14	Operating Cost Estimates.....	249
25.15	Economic Analysis.....	249
25.16	Risks and Opportunities.....	249
25.16.1	Risks	249
25.16.2	Opportunities	252
25.17	Conclusions	253
26	RECOMMENDATIONS	254
26.1	Introduction	254
26.2	Recommendations Phase 1	254
26.3	Recommendations Phase 2	254
26.3.1	Geological Modelling	254
26.3.2	Mining and Geotechnical Studies	255
26.3.3	Metallurgy and Processing	256
26.3.4	Tailings and Water Management.....	256
26.3.5	Engineering and Infrastructure	256
26.3.6	Permitting.....	256
26.3.7	Environmental, Social and Cultural Heritage.....	257
27	REFERENCES	258

TABLES

Table 1-1:	Measured and Indicated Mineral Resource Statement	12
Table 1-2:	Inferred Mineral Resource Statement.....	12
Table 1-3:	Mineral Reserves Statement	14
Table 1-4:	Metal Price Forecast.....	25
Table 1-5:	2021 PFS Capital Cost Estimate Summary.....	27
Table 1-6:	Open Pit LOM Operating Cost Forecast.....	27
Table 1-7:	Operating Cost Estimate, 2021 PFS (by area).....	29
Table 1-8:	Project Financial Metrics.....	30
Table 4-1:	Red Chris Main Block Claims	49
Table 4-2:	Red Chris South Block Claims	50
Table 6-1:	Exploration and Development History	60
Table 6-2:	Production History	61
Table 7-1:	Red Stock Phases	66
Table 10-1:	Project Drill Hole Summary Table (as at 30 September, 2021).....	87
Table 10-2:	Drill Holes Supporting Mineral Resource Estimate	87
Table 10-3:	Drill Methods	90
Table 11-1:	Analytical Methods	98
Table 13-1:	Testwork Program Dates and Status	106
Table 13-2:	Comminution Results	112
Table 14-1:	Outlier Restrictions	122
Table 14-2:	Measured and Indicated Mineral Resource Statement.....	128

Table 14-3:	Inferred Mineral Resource Statement	128
Table 15-1:	Ore Types by NSR Value	131
Table 15-2:	Shut-off Values	134
Table 15-3:	Mineral Reserves Statement	134
Table 16-1:	Key Equipment Requirements, Open Pit	142
Table 16-2:	Underground Block Cave Mine Design Parameters	152
Table 16-3:	Mine Design Assumptions	153
Table 16-4:	Cave Metrics	153
Table 16-5:	Extraction Level Metrics	154
Table 16-6:	Undercut Level Metrics	155
Table 16-7:	Mine Establishment Equipment List (Development and Cave Establishment)	159
Table 16-8:	Production Equipment List	159
Table 17-1:	Design Criteria, Central Case	172
Table 17-2:	Design Criteria, Upside Case	177
Table 18-1:	Surface Infrastructure Required in 2021 PFS to Support Block Cave Mining Operation .	185
Table 18-2:	TIA Expansion Designs	190
Table 19-1:	Metal Payable Scale	202
Table 19-2:	Deleterious Elements Penalty Schedule	202
Table 19-3:	Anticipated Product Specification Changes	204
Table 19-4:	Metal Price and Exchange Rate Forecasts	204
Table 21-1:	2021 PFS Capital Cost Estimate Summary	218
Table 21-2:	Open Pit LOM Operating Cost Forecast	220
Table 21-3:	Operating Cost Estimate, 2021 PFS (C\$/t processed)	223
Table 21-4:	Operating Cost Estimate, 2021 PFS (by area)	223
Table 22-1:	LOM Capital Cost Estimate	226
Table 22-2:	LOM Operating Cost Estimate	226
Table 22-3:	Project Financial Metrics	228
Table 22-4:	Cash Flow Analysis on an Annualised Basis (Year 2022 to Year 2030)	229
Table 22-5:	Cash Flow Analysis on an Annualised Basis (Year 2031 to Year 2040)	230
Table 22-6:	Cash Flow Analysis on an Annualised Basis (Year 2041 to Year 2050)	232
Table 22-7:	Cash Flow Analysis on an Annualised Basis (Year 2051 to Year 2060)	233
Table 22-8:	Cash Flow Analysis on an Annualised Basis (Year 2061 to Year 2066)	234
Table 26-1:	Proposed Feasibility Study Budget	255

FIGURES

Figure 2-1:	Red Chris Operations Location Plan	37
Figure 4-1:	Red Chris Mineral Tenure Map	48
Figure 4-2:	Mining Leases and Current Mine Layout	52
Figure 4-3:	20201 PFS Layout In Relation To Mining Leases	53
Figure 7-1:	Regional Geological Map	63
Figure 7-2:	Project Geology Map	64

Figure 7-3:	Red Chris Lithological Model, East Zone (Section 27N).....	67
Figure 7-4:	Red Chris Alteration Model, East Zone (Section 27N).....	70
Figure 7-5:	Red Chris Quartz Vein Volume Model, East Zone (Section 27N)	71
Figure 7-6:	Red Chris Sulphide Speciation Model East Zone (Section 27N).....	72
Figure 8-1:	Schematic Section, Porphyry Copper Deposit.....	75
Figure 9-1:	Geochemical Sampling	79
Figure 9-2:	Geophysical Surveys	81
Figure 9-3:	Near-Mine Targets	83
Figure 9-4:	Mineralization Long Section View	84
Figure 9-5:	East Ridge, Oblique Schematic Section View	85
Figure 10-1:	Project Drill Hole Location Map.....	88
Figure 10-2:	Red Chris Drill Collar Location Plan View.....	89
Figure 10-3:	Red Chris Drill Collar Location Long-Section.....	89
Figure 13-1:	Cross-Section Showing Sample Locations	108
Figure 13-2:	Location Map, Horizon Composite Samples.....	109
Figure 13-3:	Two-Stage Cleaner Test Flowsheet.....	113
Figure 13-4:	Locked Cycle Testwork Flowsheet.....	115
Figure 14-1:	Example Cross-Section Showing Block Classification (Easting 45680).....	125
Figure 14-2:	Cross Section of Gold and Copper Grades Showing Open Pit vs Underground Model (section 452680).....	127
Figure 16-1:	Open Pit Geotechnical Domains	137
Figure 16-2:	Whittle Shell Results Compared to Reserve Open Pit Design	139
Figure 16-3:	Open Pit Phase Design Long Section.....	141
Figure 16-4:	Open Pit Stockpile and WRSF Location Plan	142
Figure 16-5:	Projected Fracture Limit	145
Figure 16-6:	Schematic Cross-Section Showing Ultimate Caving Subsidence Zone	145
Figure 16-7:	Mining Footprint Design Schematic	149
Figure 16-8:	Access Schematic Showing Conveyor and Decline Portals	150
Figure 16-9:	Material Handling System Schematic	156
Figure 16-10:	Ventilation Schematic.....	157
Figure 16-11:	Open Pit to Underground Transition	160
Figure 16-12:	Central Case Production Sequence.....	160
Figure 16-13:	Forecast Combined Production Schedule	161
Figure 16-14:	Forecast Metal Production Profile	161
Figure 17-1:	Plant Flowsheet (as at May 2021).....	165
Figure 17-2:	Central Case Proposed Flowsheet	170
Figure 17-3:	Process Plant Layout Incorporating Block Cave Upgrade	171
Figure 17-4:	Upside Case Proposed Flowsheet.....	176
Figure 18-1:	Infrastructure Location Plan	186
Figure 18-2:	TIA Infrastructure Layout Map.....	191
Figure 22-1:	Free Cash Flow	236
Figure 22-2:	Sensitivity Analysis, IRR	237
Figure 22-3:	Sensitivity Analysis, NPV	237

1 SUMMARY

1.1 Introduction

Newcrest Mining Limited (Newcrest) has prepared this Technical Report (the Report) on the Red Chris Operations (Red Chris Operations or the Project), in British Columbia (BC), Canada. The Project location is shown in Figure 2 1.

The Red Chris Operations are managed by an unincorporated joint venture, the Newcrest Red Chris Joint Venture, between Newcrest Red Chris Mining Limited, a wholly-owned Newcrest subsidiary, and Red Chris Development Company Ltd. a wholly-owned subsidiary of Imperial Metals Corporation (Imperial). Newcrest has a 70% joint venture interest through Newcrest Red Chris Mining Limited, and is Project manager. Imperial has a 30% interest.

The Red Chris Operations are an open pit operation, producing 10–11 Mt/a ore. Newcrest plans to transition to a block cave underground mining operation that will produce 13.6 Mt/a. This Report discusses the remaining open pit life-of-mine (LOM) plan, and the results of the “Red Chris Block Cave Pre-Feasibility Study” (the 2021 PFS) evaluating the proposed block cave (the block cave project).

1.2 Terms of Reference

This Report supports Newcrest’s disclosures in the news release dated 12 October, 2021, entitled “Red Chris Block Cave Pre-Feasibility Study confirms Tier 1 potential”.

The Report also supports Imperial’s disclosures in the news release dated 11 October, 2011, entitled “Red Chris Block Cave Pre-Feasibility Study Confirms Low Cost, Long Life”.

For the purposes of this Report, the name Newcrest is used interchangeably for the Newcrest parent, Newcrest operating subsidiary and the Newcrest Red Chris Joint Venture.

All measurement units used in this Report are metric unless otherwise noted, and currency is expressed in United States (US\$) or Canadian (C\$) dollars as identified in the text. Cost estimates for the open pit operations are generally reported in US\$, and the 2021 PFS costs for the proposed block cave project are typically in C\$.

Mineral Resources and Mineral Reserves were initially classified using the 2012 edition of the Australasian Joint Ore Reserves Committee (JORC) Code (2012 JORC Code). The confidence categories assigned under the 2012 JORC Code were reconciled to the confidence categories in the Canadian Institute of Mining, Metallurgy and Petroleum (CIM) Definition Standards for Mineral Resources and Mineral Reserves (May 2014; the 2014 CIM Definition Standards). As the confidence category definitions are the same, no modifications to the confidence categories were required. Mineral Resources and Mineral Reserves in this Report are reported in accordance with the 2014 CIM Definition Standards.

1.3 Project Setting

The Red Chris Operations are a copper–gold open pit mining operation located in northwest British Columbia, Canada, approximately 18 km southeast of the Iskut village, 80 km south of Dease Lake, and 12 km east of the Stewart-Cassiar Highway 37.

Road access to the Project area from Highway 37 is via an 18 km-long gravel road. Most of the Project is accessible only by foot or by helicopter.

The nearest airports with regular commercial flights are in Terrace and Smithers, each approximately 500 km to the south. The Dease Lake airport, approximately 80 km to the north via BC Highway 37, is the transit point for the fly-in/fly-out operations. Chartered aircraft fly employees to the Dease Lake airstrip from where they are transported by bus to the mine site.

A range of infrastructure and associated facilities are available in Terrace and Smithers. Dease Lake is the service and government centre for residents of the region. Stewart is the nearest port with ship loading facilities, a distance of 320 km by road from the Red Chris Operations.

The climate in the Project area is northern temperate with moderately warm summers and cold dry winters. Mining operations are conducted on a year-round basis. Exploration activities can be temporarily curtailed by winter conditions.

The Project is situated on the eastern portion of the Todagin upland plateau that forms a subdivision of the Klastine plateau along the northern margin of the Skeena Mountains. Elevations on the plateau are typically 1,500 ± 30 m, with relatively flat topography broken by several deep creek gullies.

Vegetation consists of spruce and balsam forest cover with stands of aspens and scrub conifers at the lower elevations while buckbrush, willow and slide alder are common along the steep-sided, incised creek valleys. At higher elevations dwarf birch, willow and balsam dominate. Above the tree line at about the 1,370 m elevation contour, alpine grasses and flowers are the predominant vegetation.

The Red Chris Operations are located within the territory of the Tahltan Nation. The Tahltan collectively hold rights to hunt, fish, trap and harvest berries and other food and medicinal plants throughout their asserted traditional territory. Tahltan members of local communities traditionally hunt moose, caribou, sheep, goat and groundhog in the Project vicinity.

The mine area falls within the area covered in the Cassiar Iskut Stikine Land and Resource Management Plan. Exploration and development for minerals and energy, including development of road access, are acceptable activities throughout the plan area outside of protected areas, subject to regulations or statutes.

1.4 Mineral Tenure, Surface Rights, Water Rights, Royalties and Agreements

The Project comprises the Red Chris Main claim group and the Red Chris South claim group. The two groups collectively consist of 77 mineral tenures covering a total area of approximately 23,142 ha. The main tenures for purposes of the LOM plan are five mining leases issued on 20 June 2012, for a term of 30 years, with an expiry date of 20 June 2042.

All land in the immediate vicinity of the Red Chris Operations is Crown land. Surface rights to support the open pit operations are permitted by the granted Environmental Assessment Certificate and permit M-240 issued pursuant to the *Mines Act*. Permit amendments would be required to support planned underground mining activities.

Applications for groundwater licences under the Water Sustainability Act were submitted and are under review by the Ministry of Forests, Lands, Natural Resource Operations & Rural Development (FLNRORD) for new and existing groundwater use for 'Mining Use' (tailings impoundment area (TIA) production wells) and for groundwater existing use for 'Industrial Purpose' (camp wells).

An Impact, Benefit and Co-Management Agreement (IBCA) between the Tahltan Central Government, the Iskut First Nation, the Tahltan Band and the Red Chris Operations is in place. The IBCA was restated and amended on 15 August 2019 in connection with Newcrest's acquisition of its interest in the Project. The IBCA provides the basis for a life-of-mine partnership covering royalties, education, training, employment, contracting opportunities, capacity support, provisions for communication, and interaction on social and environmental matters.

1.5 Geology and Mineralization

The Red Chris deposit is considered to be an example of a porphyry copper–gold deposit.

The regional geological setting comprises island arc volcanic, sedimentary, and plutonic rocks of the Middle to Late Triassic Stuhini Group, the Early to Middle Jurassic Hazelton Group, and the Middle and Upper Jurassic to Lower Cretaceous Bowser Lake Group, which form the accreted geological terrane of Stikinia in the northern Intermontane Belt of the Canadian Cordillera. Several large calc-alkalic Late Triassic plutons (Stikine suite), including the Red Stock, host to the Red Chris deposit, cut the Stuhini Group.

The Red Stock is about 8 km long by 1.5 km wide at surface, and elongate in the east–northeast direction. It is divided into three main intrusive phases. Several significant faults cut the Red Stock, influence patterns of mineralisation and alteration, and involve late mineral and/or post-mineral displacement.

The Red Chris deposit is about 3.4 km in strike length, 0.3 km in width and over 1.3 km in vertical extent. There are two main zones, East and Main. The Main zone is 1,200 m in strike length, 300 m width and has been drill tested to 1,300 m depth. The East zone is 1,200 m in strike length, 300 m in width and has been drill tested to 1,400 m depth.

Mineralisation consists of thin wavy or thicker planar quartz veins containing chalcopyrite, bornite and magnetite. These minerals are also disseminated outside the veins. In the upper part of the deposit, the bornite-rich mineralisation was overprinted by sericite and clay alteration and associated sulphidation. Gold occurs as microscopic inclusions in the copper sulphides, and occasionally as free grains in high-grade zones.

1.6 History

Prior to Newcrest acquiring its Project interest, companies that had been actively exploring in the Project area included: Bolero Resources Corporation, Conwest Exploration Ltd., Great Plains Development Company of Canada Ltd. (Great Plains), Silver Standard Mines Ltd. (Silver Standard), Ecstall Mining Limited (Ecstall), Texasgulf

Canada Ltd. (Texasgulf), Dryden Resource Corp. (Dryden), Falconbridge; Norcen Energy; Teck Corporation, American Bullion Minerals Ltd. (American Bullion), bcMetals Corporation (bcMetals), and Imperial. From 1956–2018, activities included: reconnaissance and geological mapping; geochemical sampling (soil, rock chip, trenches); geophysical surveys (induced polarization, ground magnetic, very low frequency electromagnetic, seismic, direct current induced polarization and magnetotellurics, borehole acoustic televiewer surveys); core drilling; metallurgical testwork; mineral resource and mineral reserve estimates; acid base accounting studies; baseline environmental studies; petrographic studies; water bore and condemnation drilling in support of mine development; environmental studies and surveys in support of project permitting; and mining studies. Imperial commenced mine construction in May 2012, and was completed May 2014. The first full year of open pit mine production was 2016.

Newcrest acquired a 70% interest in the Red Chris Operations in 2019. Work conducted since that date includes updates to Mineral Resource and Mineral Reserve estimates, internal mining studies to assess potential block caving operations, additional environmental and supporting studies, core drilling, geophysical surveys (ZTEM, gravity, magnetics) and completion of the 2021 PFS.

Production from 2015 to Q3 2021 totalled 66 Mt processed, generating 491 Mlb copper, 305 koz gold and 962 koz silver contained in concentrates.

1.7 Drilling and Sampling

Project-wide, a total of 1,477 drill holes and test pits (about 400,974 m), has been completed. Core drilling is the predominant drill type.

A total of 487 core holes (287,535 m) support the Mineral Resource estimates, from the Texasgulf, American Bullion, bcMetals, Imperial, and Newcrest drill programs.

Core sizes included PQ3 (83.1 mm core diameter) HQ (63.5 mm), HQ3 (61.1 mm), NQ (47.6 mm), NQ3 (45.1 mm), and BQTK (40.7 mm).

Geological logging varied by operator. During Imperial and Newcrest programs, data collected included qualitative descriptions of lithology, alteration, mineralisation, veining, and structure, including orientation of key geological features. The geotechnical data collected included core recovery, rock quality designation (RQD), fracture counts, core strength, and overall ratings, with special attention paid to the occurrence of slickensides and fault gouge. All drill cores were photographed, prior to cutting and/or sampling the core. Magnetic susceptibility readings were taken. Core recovery is close to 100% and the sample quality is considered to be excellent.

Drill collar locations were surveyed using either total station or global positioning system instruments. Down-hole surveys were performed using Reflex or TruShot tools.

In the opinion of the QP, the quantity and quality of the logged geological data, collar, and downhole survey data collected in the exploration and infill drill programs are sufficient to support Mineral Resource and Mineral Reserve estimation and mine planning.

Prior to Imperial acquiring the Project, the length of the sampled interval depended upon geological rock contacts, core size, and changes in mineral intensity, but generally averaged 3 m with NQ core and 2 m with HQ core. During Imperial's programs, sample

intervals were marked at 2.5 m (maximum) intervals starting from zero, or less if required by major geological contacts. Where a geological contact affected the grade distribution, the geologist would mark a sample contact at the geological contact as well. During the Newcrest programs, core was cut using a manual or automatic core-cutter and half core sampled at 2 m intervals. Cover sequences were not sampled.

Density data were obtained using the Archimedes method. Several thousand density measurements support Mineral Resource estimation.

Third-party, independent analytical and sample preparation laboratories have included Min-En Laboratories, Smithers, BC; Chemex Laboratories Ltd., North Vancouver, BC; International Plasma Laboratory Ltd., Vancouver BC; ALS Chemex, Vancouver, BC (successor to Chemex); Acme Laboratories, Vancouver BC; and Bureau Veritas Commodities Canada Ltd., Vancouver, BC. Imperial used the Mt Polley and Red Chris mine laboratories, which are not independent, for check assaying and grade control, respectively.

Sample preparation and analytical methods varied over time. Early sample preparation consisted of crushing to minus ¼ inch, and pulverizing to 95% passing 150 mesh; or crushing to -10 mesh, and pulverizing to 95% passing 150 mesh. More recently, sample preparation consisted of crushing to 80% passing a nominal 3–5 mm, and pulverizing to 85% passing 200 mesh, and crushing to 95% passing 4.75 mm, and pulverizing to 95% passing 106 µm.

Initially copper assays were performed using atomic absorption spectroscopy (AAS) on a three- or four-acid digest. Later, copper and iron were analysed by inductively coupled plasma (ICP) atomic emission spectroscopy (AES) with an aqua-regia digestion. During early programs, gold was assayed using fire assay on a 30 g or one assay ton sample weight. Later programs used a 30 g sample by fire assay with an ICP–AES finish. Selected samples were analysed using a 30-, 31-, 36- or 48-element suite via ICP. Carbon and sulphur were determined by Leco.

QA/QC procedures were in place for the Imperial and Newcrest drill programs. The process generally involved submission and analysis of standard reference materials (SRMs), blanks, and duplicates. Newcrest conducted a detailed QA/QC review of the data in the database as at end-February 2021. Drilling results reviewed were primarily from the Imperial (2007–2018) and Newcrest (2019–2021) campaigns. Overall, the dataset is acceptable for use in preparing a Mineral Resource estimate for copper and gold.

The Red Chris Operations assay and geological data are electronically loaded into acQuire and the database is replicated in Newcrest's centralised database system in Melbourne. The database is regularly backed up, and copies are stored both offsite and in Newcrest facilities.

Sample security at the Red Chris Operations has not historically been monitored. Sample collection from drill point to laboratory relies upon the fact that samples are either always attended to, or stored in the locked on-site preparation facility, or stored in a secure area prior to laboratory shipment. Chain-of-custody procedures consist of sample submittal forms to be sent to the laboratory with sample shipments to ensure that all samples are received by the laboratory.

In the opinion of the QP, the sample preparation, analysis, and security practices, data collection, and quality are acceptable, meet industry-standard practices, and are

adequate to support Mineral Resource and Mineral Reserve estimation and mine planning purposes.

1.8 Data Verification

Over 90% of the Imperial assay data were electronically loaded into acQuire from the original laboratory assay files. Historical assay data prior to Imperial's Project interest were imported and validated as part of verification in support of technical reports prepared under NI 43-101.

Newcrest includes both internal and third-parties in the data verification steps:

- Internal verification: laboratory inspections; review of geological procedures, resource models and drill plans; sampling protocols, flow sheets and data storage; specific gravity data; logging consistency, down hole survey, collar coordinate and assay QA/QC data; geology and mineralisation interpretation;
- External verification: a number of data verification programs were conducted in support of technical reports on the Project, from 2004–2021. These indicated, that at the time each database iteration was reviewed, there were no significant issues that would have precluded Mineral Resource estimation or imposed confidence classification limits on certain data support.

The QP reviewed the reports and is of the opinion that the data verification programs indicate that the data stored in the Project database accurately reflect original sources and are adequate to support geological interpretations and Mineral Resource and Mineral Reserve estimation, and in mine planning.

Observations made during the QP's site visit, in conjunction with discussions with site-based technical staff also support the QP's conclusion that Newcrest's processes for geological interpretations, and analytical and database quality are being followed. Adequate steps were undertaken to verify assay data prior to Newcrest's Project interest.

1.9 Metallurgical Testwork

1.9.1 Open Pit

The Red Chris process plant was commissioned on open pit ore in 2015. Testwork on the open pit ores was primarily completed at G&T Metallurgical Services in Kamloops, BC during 2004.

The metallurgical testwork on open pit ores supporting the current process plant design included mineralogy, grind size tests, batch flotation tests, locked cycle flotation tests (pulp density, pH, reagent dosage, flotation residence time and grind size effects), gravity concentration testwork, ball mill and rod mill grinding work index tests, evaluation of metallurgical variation between the Main and East zones, and a pilot plant program. The testwork indicated that a conventional grinding and flotation process plant design could be used.

Recovery predictions made prior to Newcrest's Project interest were significantly higher than seen in actuality from the plant. Newcrest performed two orebody knowledge programs to more reliably predict the performance of the remaining ore in the open pit.

Recovery for copper and gold are defined by four metallurgical domains with recovery formulas being a function of the gold and copper grade in combination with the mill production rate. The LOM copper recovery was estimated to be 79% and gold recovery was estimated to be 51% within the Mineral Reserves amenable to open pit mining.

The equation used to forecast the copper recovery is:

- $\text{Cu recovery} = (9.7 * \text{Cu Head Grade} * 100 + 80.224) / 100 * 0.945 - 0.39 / 100$

Where the copper head grade format is, for example, 0.40%.

The equation used to forecast the gold recovery is:

- $\text{Gold recovery} = (1.859 + 0.124 * \text{LN}(\text{Au head grade}) - 0.169 * \text{LN}(1403)) * 0.95$

Where the gold head grade is in g/t. LN = natural log.

These regression equations are informed by plant recovery performance data.

1.9.2 Block Cave Underground

Laboratories used since 2019 include Base Met Laboratories in Kamloops, BC, ALS Laboratories in Burnaby, BC and Amtel in London, ON.

Testwork completed in support of the 2021 PFS consisted of mineralogy; comminution tests (hardness (hardness index testing (HIT); JK breakage parameters (Axb); semi-autogenous grind (SAG) mill comminution (SMC)), SAG mill specific energy, Bond indices (drop weight index (DWi), Bond ball mill work index (BW_i)), abrasion index (A_i), specific gravity); gravity-recoverable gold; flotation optimization tests; open circuit cleaner at standard and optimized conditions; rougher flotation; re-grind; cleaner flotation; locked cycle tests; concentrate dewatering; HydroFloat; and material classification for environmental purposes. The testwork completed is adequate to ensure an appropriate representation of metallurgical characterisation and the derivation of corresponding metallurgical recovery factors for the open pit mineralization. The 2021 PFS metallurgical testwork program confirmed that a flowsheet incorporating crushing, grinding, flotation, and concentrate dewatering was suitable for the mineralization within the planned block cave.

Recoveries for copper are a function of the copper grades in combination with the mill production rate. In the case of gold recoveries, the gold to sulphur ratio is the primary factor impacting plant recoveries.

A linear model with head grade was fitted to the copper recovery data at a grind size P₈₀ of 150 µm; a maximum of 92% copper recovery was applied to the equation as a logical constraint:

- $\text{Copper recovery (\%)} \sim 76.5 + 11.9 * \text{Cu}$ (maximum copper recovery of 92%)

Where: Cu = copper head grade in percent.

This recovery equation gives a LOM average recovery range of 81–86%.

The block cave samples show significantly higher gold recovery than open pit material at equivalent head grades as well as greater variance. The predictive equation for gold recovery of the block cave ore at a grind size P₈₀ of 150 µm is:

- $\text{Gold recovery (\%)} \sim 72.5 + 9.3 * \text{LN}(\text{Au/S})$

Where: Au = head grade in g/t, and S = sulphur head grade in percent. LN = natural log.

The forecast LOM average recovery range for gold for the mineralization within the proposed block cave is 60–75%.

The underground variability program showed that most ore samples had lower pyrite content than open pit ores, and some had secondary copper minerals such as bornite. Results indicated that, on average, concentrate grades in the second cleaner concentrate in laboratory tests exceeded the current operational target of 23% Cu. A maximum of 28% Cu was assumed in regressions to predict concentrate grade. It is possible that the favourable mineralogy of underground ores could result in still higher concentrate grades from time to time.

The equation is:

- Copper grade in concentrate (% Cu) $\approx 13.2 + 21.8 * \text{Cu:S in feed (minimum 23\%, maximum, 28\%)}$

Where: Cu = copper head grade in percent, and S = sulphur head grade in percent.

Deleterious elements potentially include mercury and antimony. The current limit for mercury penalty payment is 40 ppm in concentrate. Approximately one-third of the mercury in the plant feed is highly floatable and will be recovered to copper concentrate. However, indications are that most underground ores are not expected to produce concentrates that would trigger penalty mercury levels. These observations are based on a combination of laboratory testwork results as well as predictions from underground mine plan mercury head grades.

Antimony has generally been observed in open pit and underground concentrates at levels below those that would trigger a penalty (0.01%).

1.10 Mineral Resource Estimation

The key lithologies are the porphyry units (P1, P2, P3), the Stuhini Group volcanic and sedimentary rocks, the Bowser Lake Group, and the mafic dykes. The mafic dykes were not modelled separately at the block model scale, as they are narrow and discontinuous. The other lithologies were modelled. A geologically-based six-domain alteration model was built for the East Zone using Leapfrog software, based on drill hole logging data, photo relogs, assays, and Corescan data. A geologically-based five-domain sulphide model was built using Leapfrog software based on drill hole data that was primarily collected by Newcrest. Due to the diffusive nature of the porphyry, the copper and gold mineralisation are primarily within the different porphyry phases, rather than within the major alteration zones; hence, the lithology domains were used in estimation.

Geostatistical analysis was conducted to review individual elements and correlations between elements. Contact plots were constructed to determine boundary constraints between domains. Histogram plots were constructed in support of grade capping evaluation. Both copper and gold had positively skewed distributions. Density data approximated a normal distribution.

Sampling was typically on 2.5 m intervals, which were composited to 12 m lengths. The 12 m composite length was considered appropriate for the mineralization style and matches the vertical dimension (RL) of the selective mining unit.

Bulk density data were interpolated using an inverse distance weighting to the third power (ID3) interpolation. No grade caps were imposed on the gold or copper data.

However, to make sure that the potential smearing of outlier grades was reduced, a grade and distance restriction was applied to selected variables during the estimation process.

Variograms for the Red Stock domains were run on copper, gold, silver, iron, sulphur, mercury, antimony and arsenic. Kriging neighbourhood analysis was carried out to determine the appropriate estimation neighbourhood parameters for use in the estimation of copper and gold.

Estimation used a panel block size of 80 mE x 80 mN x 12 mRL and a selective mining unit block size of 20 mE x 20 mN x 12 mRL. Two block models were constructed, the first with the selective mining unit size and the second with the panel size. The domains were initially flagged using MineSight software at the selective mining unit size, then the flagged block model was imported to Isatis. All estimation was performed in Isatis software.

In the Red Stock domain, the following steps were undertaken:

- Estimate copper, gold, iron and sulphur using a three-dimensional ordinary kriging (OK) and uniform conditioning method;
- Estimate calcium and magnesium using a three-dimensional co-ordinary kriging and multivariate uniform conditioning method;
- Localize the uniform conditioning and multivariate uniform conditioning results to the selective mining unit;
- Estimate silver, arsenic, antimony, mercury and carbon to the selective mining unit.

The remaining three domains, sediment, volcanic and Bowser, were estimated using the following:

- Three-dimensional OK or co-ordinary kriging to estimate copper, gold, silver, iron, sulphur, arsenic, antimony and mercury grades;
- Carbon was estimated using OK in the sediment and volcanic domains;
- Carbon was estimated using a nearest-neighbour method in the Bowser domain.

Validation checks included examination of the block model and composites in plan and section views, domain level statistical checks, global statistical checks, comparison of the estimated value with a metal-at-risk analysis for copper and gold, comparison of the multivariate correlation of the input value and the block estimate, discrete Gaussian models, and conditional simulation models (swath plots). All checks indicated that the estimates were acceptable.

The Mineral Resource was classified based on an evaluation of factors including search strategy, number of informing composites, average distance weighting of composites from blocks, kriging quality parameters, geological and grade continuity, drill spacing and drill data quality, mining method and mining selectivity, and mining rate and cut-off value. Classifications included:

- No Measured Mineral Resources were classified for material other than stockpiles. Stockpile classifications are supported by grade control models;
- An Indicated Mineral Resource was classified where the average weighted distance between informing data was <100 m, and the slope of regression was >0.7;

- An Inferred Mineral Resource was classified where the block was outside the Indicated classification, the average weighted distance of the informing data was <175 m, and the slope of regression was >0.4.

Mineral Resources were estimated assuming both open pit and underground mining methods.

The Mineral Resources potentially amenable to open pit mining methods were constrained within a pit shell that assumed the following:

- Conventional truck and shovel operation;
- 11 Mt/a mining rate;
- Copper price: US\$3.40/lb;
- Gold price: US\$1,400/oz;
- Exchange rate: C\$:US\$ of 0.80;
- Unit cost assumptions of C\$2.27/t mining, C\$0.15/t stockpile rehandle, C\$7.72/t processing, C\$4.33/t G&A, with off-site concentrate transport, treatment, and refining costs included in the net smelter return (NSR);
- LOM average metallurgical recoveries range from 50–61% for gold and 81–83% for copper;
- Overall pit slope angles range from 34–46°;
- Relative level restriction of 1,112 mRL to define the open pit to underground interface at approximately 50 m below the current LOM open pit design;
- NSR marginal cut-off value of C\$12.20/t to meet processing and general and administrative (G&A) costs.

The Mineral Resources potentially amenable to underground mining methods were constrained within a conceptual cave footprint based on a potentially economic outline determined by the NSR of each block in the resource model below the open pit shell, assuming the following parameters:

- A mass mining method (block cave or sub-level cave) with no internal selectivity, hence the entire in situ contents of the outline were reported;
- 13.6 Mt/a mining rate;
- Copper price: US\$3.40/lb;
- Gold price: US\$1,400/oz;
- Exchange rate: C\$:US\$ of 0.80;
- Unit cost assumptions of C\$6.56/t mining, C\$10.05/t processing, C\$4.33/t G&A, with off-site concentrate transport, treatment, and refining costs included in the NSR;
- LOM average metallurgical recoveries range from 50–61% for gold and 81–83% for copper;
- Underground footprint based on a minimum approximate footprint of 160 x 160 m area with vertical walls and variable height of draw;

- NSR breakeven cut-off value of C\$21.00/t to meet mining, processing, and G&A costs.

Both estimates assume that the process method will be a conventional sulphide flotation producing a gold-bearing copper concentrate, and that there will be no penalties imposed on the concentrate.

1.11 Mineral Resource Statement

Mineral Resource estimates are reported with an effective date of 30 June, 2021, and are reported inclusive of those Mineral Resources converted to Mineral Reserves. Mineral Resources that are not Mineral Reserves do not have demonstrated economic viability.

Mineral Resources are tabulated in Table 1-1 for the Measured and Indicated Mineral Resources and in Table 1-2 for the Inferred Mineral Resources. Mineral Resources were estimated as at 31 March 2021, and depleted to 30 June 2021.

The Qualified Person for the estimate is Mr. Rob Stewart, FAusIMM, whose job title at Newcrest is Group Manager Resources. Mr. Stewart is a Newcrest employee.

Factors that may affect the Mineral Resource estimate include changes in local interpretations of mineralization geometry and continuity of mineralized zones; changes to geological and grade shape and geological and grade continuity assumptions; changes to metallurgical recovery assumptions; changes to the input assumptions used to derive the conceptual open pit used to constrain the estimate; changes to the input assumptions for assumed block caving operations; changes to the NSR cut-offs applied to the estimates; variations in geotechnical, hydrogeological and mining assumptions; forecast dilution; and changes to environmental, permitting and social license assumptions.

1.12 Mineral Reserve Estimation

Measured and Indicated Mineral Resources were converted to Proven and Probable Mineral Reserves with the application of modifying factors. Inferred Mineral Resources were set to waste. Mineral Reserves were estimated using open pit and block cave underground mining assumptions.

1.12.1 Open Pit

Mineral Reserves were estimated from the resource block model with the following modifying factors:

- Pit design volumes (phase triangulations) for Phase 5, Phase 7 and Phase 8;
- Material routing (Codee) variable, which was the value descriptor for material routing and used in financial year (FY) FY22Q1 operating and sustaining capital assumptions used for net smelter return (NSR) calculations;
- Ore types were based on marginal, break-even and elevated cut-offs. An NSR script calculated the value of each block model block by determining revenue after element recovery and selling costs. Six ore types were differentiated;

Table 1-1: Measured and Indicated Mineral Resource Statement

Resource Classification	Assumed Mining Method	Tonnes (Mt)	Grade		Contained Metal	
			Au (g/t)	Cu (%)	Au (Moz)	Cu (Mt)
Measured	Open pit and stockpiles	11	0.17	0.24	0.062	0.028
Indicated		290	0.28	0.34	2.6	1.0
Sub-total Measured and Indicated		300	0.28	0.33	2.7	1.0
Measured	Underground	—	—	—	—	—
Indicated		670	0.46	0.40	10	2.7
Sub-total Measured and Indicated		670	0.46	0.40	10	2.7
Total Measured and Indicated	Open pit and underground	980	0.41	0.38	13	3.7

Table 1-2: Inferred Mineral Resource Statement

Resource Classification	Assumed Mining Method	Tonnes (Mt)	Grade		Contained Metal	
			Au (g/t)	Cu (%)	Au (Moz)	Cu (Mt)
Inferred	Open pit and stockpiles	11	0.23	0.27	0.083	0.030
Inferred	Underground	180	0.32	0.30	1.8	0.54
Total Inferred	Open pit and underground	190	0.31	0.30	1.9	0.57

Notes to Accompany Red Chris Mineral Resource Tables:

1. Mineral Resources are reported with an effective date of 30 June, 2021, using the 2014 CIM Definition Standards. The Qualified Person responsible for the estimate is Mr. Rob Stewart, FAusIMM, Group Manager Resources, a Newcrest employee.
2. Mineral Resources are reported on a 100% basis. Newcrest holds a 70% interest in the Red Chris Joint Venture.
3. Mineral Resources are reported inclusive of Mineral Reserves. Mineral Resources that are not Mineral Reserves do not have demonstrated economic viability.
4. Mineral Resources that are potentially amenable to open pit mining methods are constrained within a conceptual open pit shell that uses the following input assumptions: metal prices of US\$3.40/lb Cu, US\$1,400/oz Au; mining costs of C\$2.27/t mined, and process and general and administrative (G&A) costs of C\$12.20/t processed; a conventional sulphide flotation producing a gold-bearing copper concentrate; metallurgical recoveries that average 50–61% for gold and 81–83% for copper; a relative level restriction of 1,112 mRL to define the open pit to underground interface; and overall pit slope angles that range from 34–46°. Mineral Resources are reported above a net smelter return of C\$12.20/t.
5. Mineral Resources that are potentially amenable to underground mass mining methods are constrained within a conceptual cave footprint, and reported using the following assumptions: metal prices of US\$3.40/lb Cu, US\$1,400/oz Au; mining costs of C\$6.56/t mined, and process and general and administrative (G&A) costs of C\$14.38/t processed; a conventional sulphide flotation producing a gold bearing copper concentrate; metallurgical recoveries that average 50–61% for gold and 81–83% for copper; a relative level restriction of 1,112 mRL to define the open pit to underground interface; and an underground footprint based on a minimum approximate footprint of 160 x 160 m area with vertical walls and variable height of draw. Mineral Resources are reported above a net smelter return of C\$21.00/t.
6. Tonnages are metric tonnes. Gold ounces are estimates of metal contained in tonnages and do not include allowances for processing losses. Copper tonnes are estimates of metal contained in tonnages and do not include allowances for processing losses.
7. Rounding as required by reporting guidelines may result in apparent differences between tonnes, grade and contained metal content. Rounding is to two significant figures.

- Dilution was assumed to be fully accounted for in the resource block model. No ore loss or dilution was applied to the Mineral Reserves.

1.12.2 Block Cave Underground

Three macroblocks (MBs) were defined, MB1, MB2 and MB3. Two mining throughputs were reviewed, one, the Central Case (that forms the base case) at 13.6 Mt/a, and the second, Upside Case (that forms an alternative case) at 15 Mt/a. The macroblocks were sized and designed to produce up to 15 Mt/a, except for MB2, which had a limit of 7.0 Mt/a applied. Although the block cave has the potential to produce at a higher rate, the production rate was governed by the planned capacity of the process plant and potential upgrades.

Mining boundaries were determined using the commercially-available PCBC software to evaluate the potential column values over various elevations and over an extended area.

A shut-off value of C\$21.00/t was used to determine the footprint boundaries. Two footprint options were designed, a traditional post undercut block cave and a single pass cave establishment, which eliminates the undercut level. The post undercut method was the base case, as the single pass cave establishment is still under trial at Newcrest's Cadia East operation.

A specified shut-off value was subsequently used for each block and draw column:

- MB1: C\$22.00/t milled;
- MB2: C\$22.80/t milled;
- MB3: C\$22.80/t milled.

MB1 caving will be initiated from the northwest corner of the footprint in order to avoid the principal stress being parallel or sub-parallel to the caving front. MB2 caving is planned to start from the northeast corner towards the southwest. MB3 caving will be initiated from the southeast corner of the footprint towards the northwest.

Dilution was modelled using the external drawpoint method to simulate surface toppling, rilling, and open pit failure. Dilution was defined as material below C\$20.70/t that enters the planned ore extraction via mixing. Dilution accounts for about 5.0% of the tonnage (approximately 20.2 Mt).

1.13 Mineral Reserve Statement

Mineral Reserves for the Red Chris Operations were reported using the confidence categories set out in the 2014 CIM Definition Standards.

Mineral Reserves are reported with an effective date of 30 June 2021 in Table 1-3.

Mineral Reserve estimates were prepared by Mr. Brett Swanson (MMSAQP), who is the Qualified Person for the open pit Mineral Reserves and the Mineral Reserves in stockpiles. Mr. Michael Sykes (FAusIMM) is the Qualified Person for the estimated Mineral Reserves to be mined by underground block cave methods. Mr. Swanson and Mr. Sykes are Newcrest employees.

Table 1-3: Mineral Reserves Statement

Reserve Classification	Mining Method	Tonnes (Mt)	Grade		Contained Metal	
			Au (g/t)	Cu (%)	Au (Moz)	Cu (Mt)
Proven	Open pit and stockpiles	—	—	—	—	—
Probable		75	0.36	0.42	0.86	0.31
Sub-total Proven and Probable		75	0.36	0.42	0.86	0.31
Proven	Underground	—	—	—	—	—
Probable		410	0.55	0.45	7.2	1.8
Sub-total Proven and Probable		410	0.55	0.45	7.2	1.8
Total Proven and Probable		480	0.52	0.45	8.1	2.2

Notes to Accompany Red Chris Mineral Reserves Table:

1. Mineral Reserves are reported with an effective date of 30 June, 2021, using the 2014 CIM Definition Standards. The Qualified Person responsible for the estimate of the Mineral Reserves amenable to open pit mining methods and in stockpiles is Mr. Brett Swanson, MMSAQP, and the Qualified Person responsible for the estimate of the Mineral Reserves amenable to underground block cave mining methods is Mr. Michael Sykes, FAusIMM, both of whom are Newcrest employees.
2. Mineral Reserves are reported on a 100% basis. Newcrest holds a 70% interest in the Red Chris Joint Venture.
3. Mineral Reserves that will be mined using open pit mining methods are constrained within a pit design that uses the following input assumptions: metal prices of US\$3.00/lb Cu, US\$1,300/oz Au; metallurgical recoveries that average 79% for copper and 51% for gold; mining costs of C\$3.2/t mined, and process and general and administrative (G&A) costs of C\$12.5/t processed; and pit slope angles that range from 34–46°. Mineral Reserves are reported above a net smelter return of >C\$15.5/t. Full mine recovery is assumed, and Mineral Reserves do not have additional dilution over that incorporated in the resource block model.
4. Mineral Resources that will be mined using underground mass mining methods are constrained within a block cave design that uses the following input parameters: metal price of US\$3.00/lb Cu, US\$1,300/oz Au; CA\$:US\$ exchange rate of 0.8; metallurgical recoveries that range from 81–86% for copper and 60–75% for gold; a life-of-mine operating cost of C\$20.34/t milled; and shut-off values of MB1: C\$22.00/t, MB2 and MB3: C\$22.80/t, resulting in an approximate dilution of 5%.
5. Tonnages are metric tonnes. Gold ounces and copper tonnes are estimates of in-situ metal and do not include allowances for processing losses.
6. Rounding as required by reporting guidelines may result in apparent differences between tonnes, grade and contained metal content. Rounding is to two significant figures.

Factors that may affect the Mineral Reserve estimates include changes to long-term gold and copper price assumptions; changes to exchange rate assumptions; changes to metallurgical recovery assumptions; changes to the input assumptions used to design the optimized open pit shell; changes to the input assumptions used to derive the cave outlines and the mine plan that is based on those cave designs; changes to include operating, and capital assumptions used, including changes to input cost assumptions such as consumables, labour costs, royalty and taxation rates; variations in geotechnical, mining, dilution and processing recovery assumptions; including changes to designs as a result of changes to geotechnical, hydrogeological, and engineering data used; changes to the NSR cut-off criteria used to constrain the open pit estimates; changes to the shut-off criteria used to constrain the underground estimates; changes to the assumed permitting and regulatory environment under which the mine plan was developed; ability to maintain mining permits and/or surface rights; ability to obtain mining permits and environmental approvals for underground mining, and the ability to maintain social and environmental license to operate.

Factors that are risk-specific to block cave operations, and which may affect the Mineral Reserves include: inrush of water into the underground workings including decline, cave levels and infrastructure areas; poorer rock mass quality and quantity than interpreted; inability to achieve planned decline development rates having impact on schedule and cost; incorrect estimation of cave propagation potentially leading to air blast; and damage to mine workings due to a seismic event.

1.14 Mining Methods

1.14.1 Open Pit

Open pit operations are conducted using conventional methods and a conventional truck and shovel fleet.

Golder Associates (Golder) defined six geotechnical domains within the open pit. Recommended inter-ramp angles ranged from 41.9–52.8°. These were adjusted to take the pit ramps into account, leading to designed slope angles from 34–46°. The greatest area of concern for pit stability is on the southern wall and in particular the Bowser Lake Group sediments. Two areas that show a factor of safety risk are associated with the Bowser Lake Group sediments near the pit crest, and are only problematic with elevated pore water pressures.

The majority of the water presenting to the open pit is derived from precipitation falling directly onto the pit walls. Groundwater is sourced from infiltration into near surface weathered country rock and open structures. Water management in the pit is based around the use of surface drains to direct water from the benches and ramp towards sumps at the base of the pit from where it is pumped into the production circuit, either directly to the mill or TIA storage. No active or passive groundwater drainage is currently installed within the pit.

Pit optimization used the revenue factor 0.98 pit. The designs resulted in three remaining pit phases, Phase 5 and Phase 8 in the East zone and Phase 7 in the Main zone.

Non-acid generating (NAG) rock is used to line the waste rock storage facilities (WRSFs) and for construction purposes. Potentially-acid generating (PAG) rock is sent to designated PAG WRSFs. WRSF space is limited to 150 Mt unless other PAG disposal areas can be permitted.

The mine uses rotary blasthole drills, and 28 m³ electric hydraulic shovels loading 230 t capacity haul trucks from 12 m benches. The operation is supported by standard ancillary equipment including an 18 m³ front-end loader, track and rubber-tired-dozers, and graders.

Ore and waste are drilled and blasted together on 12 m benches and mined in a single pass. Where practicable, walls are drilled with a pre-split to ensure stable wall rock conditions.

Ex-pit ore is allocated by gold and copper grade and either sent to the mill crusher pocket directly or sent to low-grade or mineralized waste stockpiles (material below Mineral Reserve cut-off grade).

NAG rock is used to line the WRSF and for construction. PAG rock is sent to designated PAG WRSFs.

1.14.2 Block Cave Underground

The proposed mine plan uses technology conventional to block cave operations, including mine design and equipment. The planned mining equipment is conventional to block cave operations.

The ground conditions at Red Chris are interpreted to be “very good”, based on data collected from 2018–2020. Six geotechnical domains were assessed for the proposed underground development and cave extents. Cave fragmentation analyses concluded that orebody pre-conditioning via high undercut, blast, and hydraulic means will be required due to the rock quality. All pre-conditioning works will extend from the extraction level of the macroblocks to within 75 m of the ultimate floor of the open pit (580 m above the underground footprint). Modelled cave subsidence shows no major risks with respect to surface mining infrastructure or surface features such as Kluea Lake. Camp Creek may be impacted, and further study is required in terms of in-situ stress measurements and rock mass characterisation. The creek may require diversion. The crater limit will be at the end of the LOM, at year 34, and the crater depth will be 350–400 m below the bottom of the final pit.

The main source of water that will present to the underground was determined to come from direct precipitation (rain and snowmelt) flowing through the caved mass. The planned water management capacity will range from 200 m³/hr during initial development to 1,500 m³/hr during mining of MB2 and MB3.

Each macroblock footprint will consist of an extraction level, undercut level, and infrastructure development. A single crusher and tipple arrangement will be used for all macroblocks. A perimeter drive on the extraction and undercut level will provide extraction and drill drive access and ventilation to the working areas. The footprint will be ventilated via the access decline and the 1,000 mRL return air raise via the 1,000 mRL access drive. A series of internal ventilation raises will provide exhaust ventilation for the crusher, conveyor, and tipple areas.

Access to the mine will be via two declines: the exploration/access and conveyor declines. The mine layout includes declines, ventilation infrastructure, footprint access, crusher location, and footprint layout. Primary ventilation will be achieved through three fresh air intakes, both portals and VR3, and two exhaust raises, VR1 and VR2.

Extraction levels for all macroblocks are based on the standard extraction level layout using an El Teniente layout with spacing of 32 x 20 m, a 60° turn-out angle and 5.4 m wide x 4.6 m high drives. Extraction levels will be accessed from the north of each block, with access from both east and west of each block (to extraction and undercut levels) with an additional two internal ramps to the undercut level. The extraction level was designed so that all drives in the three macroblocks drain to the south, away from the mine infrastructure that will be located on the northeast corner of the footprint.

The undercut level will be 25 m above the extraction level to accommodate the high post undercut method by ramps up from the extraction level for each macroblock. The slot drill drive will be 20 m from the closest drawbell, to allow appropriate stand-off.

The planned mining sequence is based on a combination of grade and geotechnical considerations. MB1, which hosts the high-grade portion of the Mineral Reserve will be the first to be mined. MB2 will be a southern extension of MB1, and with cave rules and stress orientation dictating that MB3 is opened from southeast to northwest, MB2 must be opened prior to MB3.

The proposed material handling system will include a single crusher to service the three macroblocks. The footprint material handling system will direct feed the crusher with load-haul-dump vehicles (LHDs), with five tip points on the 500 mRL above a ROM bin leading to the crusher on the 450 mRL. The crusher will be serviced by a five-tipple dump arrangement with a sixth access for ventilation and loader access to the rock box.

There will be an equal number of extraction drives reporting to each tipple from MB1 and MB2 to enable as high a production rate as possible with as little loader interaction as possible. A dedicated haulage loop was designed for MB3 to access the western side of the tipple arrangement.

Crushed ore will be transferred to the decline conveyor via a fine ore bin, from where it will progress to the collection conveyor and the transfer station on the 420 mRL. From the conveyor decline, ore will be transported to surface with additional transfer stations located at the 1,200 and 1,400 mRLs.

The mine will be ventilated by a “pull” or exhausting type ventilation system and was designed based on the use of diesel equipment. The primary mine ventilation fans will be located at the primary exhaust airways of the mine and will develop sufficient negative pressure to ensure all workplaces are supplied with the required fresh air such that contaminants are removed to the exhaust air system and ultimately to the surface. Airflows were allocated based upon maintaining ventilation for all concurrent mine activities.

Heating will be employed. The minimum targeted delivery air temperature for trafficable airways is 2°C.

The block cave mine will produce about 2.9 Mt of PAG waste, which will be stored on the existing permitted facilities. NAG material will be used for site construction, including the TIA.

1.14.3 Production Schedule

The Red Chris East Zone is currently being mined by open pit mining. The open pit mine is due for completion of the final phase (Phase 8) in FY26, producing a total of 63.6 Mt of ore from Q4 FY21 to Q4 FY26. The first cave ore from MB1 (located directly below Phase 8) is scheduled for the second half of FY26, with full production from MB1 in FY30. During the block cave production ramp-up the process plant feed will be supplemented by stockpiled ore. The projected underground mine life is from FY26 to FY57, with nameplate capacity of 13.6 Mt/a scheduled to be reached in FY30.

1.15 Recovery Methods

Plant design for open pit ores was based on metallurgical testwork assuming open pit mining methods, and was a standard porphyry copper flowsheet employing SAG and ball milling, flotation, regrinding, thickening and filtering to produce a gold-bearing copper concentrate at a moisture content of 8% for export. Subsequent to the initial construction, the plant has undergone the following changes: installation of a pebble bypass system on the SAG mill, installation of an additional rougher flotation cell to increase rougher flotation residence time, and installation of a third flotation column to increase capacity of the cleaner circuit.

The 2021 PFS metallurgical testwork program confirmed that a flowsheet incorporating crushing, grinding, flotation, and concentrate dewatering was suitable for the planned underground block cave material.

1.15.1 Current Plant

The plant consisted of a SAG mill–ball mill–pebble crushing (SABC) comminution circuit housed in a single process building. The target grind size was a P_{80} of 150 μm , with throughput taking precedence over grind size, resulting in typical grind sizes closer to 170–180 μm .

The flotation circuit as of May 2021 consisted of:

- Copper rougher: five Outotec TC-200;
- Mixed duty (copper rougher/sulphide rougher): one TC-200 and one TC-160;
- Regrind: primary ball mill in series with a secondary Vertimill targeting a regrind size P_{80} of 30 μm ;
- Cleaner circuit: two cleaner columns and a bank of five Outotec TC-50 cleaner scavengers;
- Concentrate storage tank, thickener, and pressure filter.

Subsequently, in June 2021, the third flotation column was commissioned.

The flotation circuit is configured to produce a copper concentrate with a grade of 23–24% Cu. Originally configured as a two-stage cleaning circuit, the plant is often operated with only a single stage of cleaning due to insufficient capacity in the cleaner columns. This no longer occurs as the third flotation column is in place.

Process improvements are underway, and include:

- Installation of a third Eriez Cavitation Tube Column in the cleaners, which started commissioning in June 2021;
- Installation of two pre-rougher duty Eriez StackCells, due to be completed by Q1 2022.

Newcrest is investigating the installation of a tailings thickener for NAG cyclone overflow. A new tailings cyclone cluster will be installed adjacent the tailings thickener, should this project proceed.

1.15.2 Plant Requirements, Block Cave Underground

The 2021 PFS evaluated process plant upgrades required to meet the different ore characteristics of underground ores compared with open pit ores, specifically increased hardness and higher copper head grades. Two process options were evaluated:

- A Central Case (that forms the base case), that would treat 13.6 Mt/a of underground ore through the existing SABC circuit plus a new single-stage SAG circuit; this concept was within the current maximum permitted throughput of 38,000 t/d average, 13.87 Mt/a;
- An Upside Case (that forms an alternatives case), that would treat 15 Mt/a of underground ore through the existing SABC circuit plus a new single-stage SAG

circuit, with SAG mill discharge configurations modified to allow coarsening of grind size, and addition of a HydroFloat coarse particle flotation circuit.

In both cases, flotation and concentrate dewatering upgrades were included to allow processing of higher head grade underground ore.

The Central Case expansion largely kept the existing process operation, added an additional grinding line and expanded some unit operations to suit block cave ore. Upgrades include a new coarse ore stockpile, single-stage SAG mill, pre-rougher StackCells, new regrind circuit and expansion of the concentrate dewatering circuit. The ore properties of underground ore are expected to be sufficiently favourable to discontinue sulphide scavenger flotation, which is required for most open pit ores. The existing regrind ball mill would be removed to create space for an expanded cleaner flotation circuit. The expansion scenario considered that the ongoing process improvement projects would be online prior to the block cave expansion, including Cleaner Column 3, Phase 1 pre-rougher StackCells (treating cyclone overflow from the existing SABC circuit), and NAG tailings thickening.

The Upside Case for the block cave process plant upgrade was an extension of the Central Case, and assumed HydroFloat coarse particle flotation and an increase in grind size at a higher throughput rate. The concept included:

- In the single-stage SAG circuit the pebble crusher will be installed in the transfer building included in the Central Case;
- The discharge and screen configurations of the SAG mills and hydrocyclone components will be modified to allow coarsening of grind size;
- A HydroFloat circuit will be installed on rougher tailings after classification;
- HydroFloat concentrate will be reground in a re-configured Vertimill VTM1500;
- Reground HydroFloat concentrate will be upgraded in a new HydroFloat rougher flotation stage that will incorporate StackCells, smaller than the ones nominated for pre-roughing duty, and the HydroFloat rougher concentrate will be blended with the existing rougher concentrate streams to feed the cleaner flotation circuit.

The Upside Case assumed that the maximum permitted throughput could be increased, sufficient make-up water could be provided to sustain the higher production rate, and the economics of the expansion to the Upside Case could be confirmed to be favourable.

1.16 Project Infrastructure

1.16.1 Infrastructure

The existing mine infrastructure includes an open pit, divided between the East and Main zones; one coarse ore stockpile, one low-grade stockpile, a WRSF; the TIA complex; non-contact water diversion structures; power supply; process plant, process facilities; exploration facilities; medical and ambulance facilities administrative and warehouse facilities; maintenance facilities; water treatment facilities; waste treatment facilities; and accommodations camp.

The transition to block cave mining and associated changes to processing will be supported by existing infrastructure as well as infrastructure upgrades. Infrastructure upgrades that have recently been completed or are currently in progress for ongoing

open pit operations, and will be integrated with the block cave project, are as required in the following areas: new mobile equipment maintenance and workshop facility; pumping upgrade from the North Reclaim dam to the booster station; seepage mitigation modifications for the TIA; new cyclone sand plants and tailings thickener for dewatering NAG tailings cyclone overflow; associated modifications to tailings pipelines for the cyclone sand plants, thickeners, and short-term tailings deposition; dust cover for the existing coarse ore stockpile; and accommodations camp upgrades.

New infrastructure requirements for the block cave project include: operations accommodation complex, site asset operation centre, mine dry, concrete/shotcrete batch plant; expansion of existing North dam and South dam, new northeast dam, relocated North Reclaim dam and South Reclaim dam, new northeast reclaim dam, North Valley pumping wells, North Valley seepage wells, make-up water booster pumps and pipelines for fresh and reclaim water, potable water treatment plant, fire water supply to operations accommodation complex, decline conveyor; propane, diesel storage and distribution; air compressors to supply compressed air to underground utility stations; sewage treatment plant, septic field; ditches around the operations accommodation complex; expansions to switchgear and substations, mine substation, site-wide reticulation; communications backbone feeding surface and underground facilities; surface haul roads, access to conveyor portal, ventilation raises, process plant, TIA dam access roads; laydown areas, construction offices, warehouse, maintenance shops, water utility supply pump/pipeline from south reclaim pond; and stockpile pads, TIA reclaim dam diversion ditches, Camp Creek diversion, and Beaver Creek diversion.

1.16.2 Tailings Impoundment Area

The TIA is currently permitted for 302 Mt of tailings, the containment of which is provided by a single impoundment with natural topography, and the LOM design incorporates three dams, the North, South, and Northeast dams, to a final elevation of 1,180 m. The North and South dams are operational and raised as needed. There are two water reclaim dams located downstream of the North and South dams, referred to as the North and South Reclaim dams, respectively.

The current mine permit requires the segregation and separate deposition of NAG and PAG tailings. PAG tailings consist of cleaner-scavenger tailings and sulphide scavenger concentrate when the sulphide scavenger stage is in operation. PAG tailings are required to be separately disposed of in the TIA and maintained in a saturated area (this is a permit condition). NAG tailings can either be deposited whole into the impoundment or cycloned to produce a cyclone sand product used for embankment construction. Cyclone underflow (the coarser fractions of NAG tailings cyclone sand) and cyclone overflow (the finer fractions of NAG tailings) are deposited in the impoundment.

To support the proposed block cave operation (including development of MB2 and MB3), the TIA will be expanded to a capacity of about 550 Mt. The design assumes raises on the North, South and Northeast dams above that which is currently permitted, to a final elevation of 1,207 m. The 2021 PFS assumes decommissioning of the existing north and south reclaim dams and associated seepage interception systems, and reconstruction of those facilities further downstream; construction of a new Northeast Reclaim dam will also be required. Existing instrumentation and wells (monitoring and pumping) may need to be decommissioned and new infrastructure installed. Existing water diversion channels or sections of existing channels will be decommissioned and

new channels built around the expanded TIA to route contact water into the TIA and non-contact water away from the TIA.

1.16.3 Water Management and Supply

The main source of water for the process plant is reclaim from the main pond at the TIA. When the planned tailings thickener is constructed, it will become the largest source of process water, supplemented by a reduced volume of reclaim water from the TIA. Other sources include seepage recovery from the north and south reclaim seepage ponds formed by the North Reclaim dam and South Reclaim dam, respectively. Groundwater pumping from the deep aquifer is the main source of makeup water when needed to meet process water demands.

The TIA will be the main water management reservoir for the Red Chris Operations. Inputs to the TIA will include water from the tailings, runoff from the TIA catchment area, direct precipitation, and pump-back from the reclaim dams. Collected water from the pit and WRSFs, including the low-grade ore stockpile, will be initially routed through the mill for process use before reporting to the TIA with the tailings. Diversion ditches around the TIA will divert non-contact runoff water to the north and south of the TIA as much as practicable. Storm water will report to the TIA. No settling or sediment control will be required prior to discharge; and there will be no storm water treatment or management infrastructure at the site for storm water runoff.

The North and South Reclaim dams will collect runoff and groundwater seepage that reports to surface from the TIA.

Three existing potable water systems support the accommodations camp and operations. Raw water is sourced from three groundwater wells, and treated through potable water treatment plants.

1.16.4 Camps and Accommodation

The current accommodation camp has an approximate 800-person capacity, and an estimated remaining usage life of 10 years. An additional 400 to 600 beds will be needed to support the construction and development phases of the Project as envisaged in the 2021 PFS.

1.16.5 Power and Electrical

Power to the Red Chris Operations is provided by BC Hydro via the Northwest Transmission Line. The current contract with BC Hydro sets the authorized demand at 55 MVA at 0.95 power factor or better, and current site demand typically fluctuates around 48 MVA. Emergency power requirements for critical systems are provided by two 1.27 MW diesel generators for the operations areas, and one 500 kW diesel generator for the camp.

The preliminary load list indicates the total site load requirements to support the block cave project will increase from 45 MW to 100 MW. The existing 287 kV substation will be increased in capacity with the addition of a third 287 kV/25 kV transformer. A new mine substation dedicated to the underground area will be constructed. Emergency power requirements in the form of two 1.2 MW diesel generators will be provided at the mine substation at the conveyor portal.

1.17 Environmental, Permitting and Social Considerations

Extensive environmental baseline data collection and monitoring of the area has occurred since 2003. Site-specific baseline studies were completed to support the 2004 Environmental Assessment Application and subsequent 2010 Joint *Mines Act* and *Environmental Act* Permit Application, as well as associated addendums to permit applications.

Following receipt of the Environmental Assessment (EA) Certificate (M05-02), *Mines Act* Permit (M-240), and *Environmental Management Act* Permit (105017), approvals for mine construction commencement (2012) and operational authorization (June 2015), the Red Chris Operations have continued to collect comprehensive environmental monitoring data to support effective environmental management.

1.17.1 Environmental Considerations

Baseline characterization studies included data collection on dust, noise and vibration, potential visual impacts, air quality and meteorology, groundwater and surface water quality and quantity, hydrogeology, aquatic resources and fisheries, terrestrial ecosystems including vegetation and wildlife, and cultural heritage and archaeological studies.

A gap analysis completed as part of the 2021 PFS identified several areas requiring additional baseline characterisation work, such as hydrogeology, aquatic resources and fisheries. Additional information is planned to be collected in the areas of dust, noise, and air quality to assess the impacts of potential incremental Project increases. Closure studies are also planned to reduce risks associated with long-term water (quantity and quality) and metals leach/acid rock drainage management post-closure, and incorporate input from Tahltan engagement.

There is an environmental management system (EMS) in place for the open pit operations, which includes associated plans, procedures, policies, guidelines, auditing, and compliance. The EMS and environmental management plans (EMPs) will be updated to incorporate the block cave project. Key mitigation measures that have been identified for impacts assessed during the 2021 PFS will inform the updates to the EMPs.

1.17.2 Closure and Reclamation Planning

A closure plan was developed for the 2021 PFS for the closure of the proposed block cave operation in its entirety, including works associated with the existing open pit operations.

The closure plan currently approved is for the closure of the existing facilities to support the open pit mine at Red Chris.

A reclamation bond is required to be updated according to the disturbance areas and facilities associated with the M-240 permit.

The closure plan for the proposed block cave project was completed for the purposes of development of a closure cost estimate. A total exit cost for the block cave project including decommissioning, closure, and reclamation of mine infrastructure associated with the existing open pit mine was estimated at a concept study level of C\$181 M.

1.17.3 Permitting Considerations

The Red Chris Operations are fully permitted for open pit mining.

The BC Reviewable Projects Regulation sets out the criteria for determining which projects are required to undergo an EA; however, Newcrest understands that the block cave project does not meet or exceed the thresholds defined in the Reviewable Projects Regulation; therefore, except in the event that the Project is designated by the Ministry of Environment and Climate Change Strategy, Canada (ENV), the Project will not require a new Environmental Assessment (EA) certificate. However, amendments to the EA certificate will be required in connection with certain phases of the block cave project (such as underground mining) where the activities to be undertaken during such phases are not authorized by the existing EA certificate. An EA certificate holder may apply to the Environmental Assessment Office for an amendment. Depending on the potential complexity of the proposed amendment, the Environmental Assessment Office may set out supplementary application requirements that may include information typically included in a detailed project description. The Minister of Indigenous Relations and Reconciliation is authorized, on behalf of the government, to negotiate an agreement with the Tahltan Central Government relating to the consent of the Tahltan Central Government in respect of decisions under the *Environmental Assessment Act* related to the Red Chris Operations and the block cave project.

The permitting strategy will follow a phased approach, including:

- Phase 1: exploration decline box cut and portal;
- Phase 2: exploration decline construction;
- Phase 3: pre-mining underground development including an extension to the decline, development of the conveyor decline, access to the ore body and underground development to support the block cave infrastructure;
- Phase 4: block cave mining of MB1;
- Phase 5: block cave mining of MB2 and MB3.

Permitting for development of the exploration decline (Phases 1 and 2) is complete and the decline is under construction.

MB1 is expected to be able to be permitted at the provincial level, through an EA certificate amendment and amendments to the *Mines Act* and *Environmental Management Act* permits. The application review process is assumed to be carried out jointly or concurrently by the Tahltan Central Government and provincial regulators pursuant to an agreement under Section 7 of the *Declaration on the Rights of Indigenous Peoples Act*. *Mines Act* and *Environmental Management Act* permit amendment applications are expected to be submitted and reviewed concurrently during the EA certificate amendment process. It is possible that EA certificate amendment process will include modernization, which may broaden the scope of the review.

Extension of the mine's operating life beyond 2040 through the mining of MB2 and MB3 will likely trigger the need for environmental review at the federal level under the *Impact Assessment Act* and additional permitting under the *Fisheries Act*. These permitting activities are estimated to be initiated after 2035.

1.17.4 Social Considerations

The mining operations are located entirely within the Tahltan Nation's territory. The proposed block cave project requires an approach that aligns with the Tahltan Nation and leadership and with provincial governments. Since initiating discussions on exploration and Red Chris Operations activities, Newcrest representatives have continued to meet regularly with Tahltan Central Government representatives, Tahltan leadership, and the Tahltan Nation. While feedback has been largely positive, a range of concerns and interests have been raised. Newcrest is actively working with Tahltan Central Government representatives, Tahltan leadership, and the Tahltan Nation to address concerns that have been raised.

1.18 Markets and Contracts

1.18.1 Markets

An evaluation of the copper concentrate market was undertaken as part of the 2021 PFS.

The Red Chris Operations' current market for the open pit concentrate is Asia (primarily China) due to China's comparative advantage i.e., nil or low penalties imposed on the elevated mercury and antimony, and lower transportation cost compared to Europe.

An ongoing dialogue is maintained with smelters globally regarding their interest in the Red Chris Operations' concentrate. For the reasons mentioned above, the strongest demand will remain to be from Chinese smelters, though counterparty evaluation needs to be carefully considered.

The assumption in the 2021 PFS is that the additional concentrate tonnage that is produced from the block cave project will either be added to existing contracts (those contracts will be expanded) or sold to new smelters customers in Asia or Europe with whom direct communication already takes place. It is not expected that Newcrest will need to pay a premium for market access. At an average grade of 24.4% Cu, Red Chris concentrate is slightly below premium concentrate grade levels, but is still expected to attract market interest.

1.18.2 Metal Price and Contract Assumptions

Metal price assumptions were provided by Newcrest management. Newcrest considers analyst and broker price predictions, and price projections used by peers as inputs when preparing the management pricing forecasts. The metal price and exchange rate assumptions used are included in Table 1-4.

Contracts are in place in support of the open pit mining and processing operations and include mill consumables, power, explosives, transportation, and camp facilities. Contracts are also in place with equipment vendors, drilling contractors, and for concentrate loading and storage.

Table 1-4: Metal Price Forecast

	Units	FY22	FY23	FY24	FY25	FY26+
Gold price	US\$/oz	1,750	1,700	1,550	1,500	1,500
Copper price	US\$/lb	3.75	3.50	3.30	3.30	3.30
Exchange rate	C\$:US\$	0.80	0.80	0.80	0.80	0.80

Contracts that are likely to be concluded in support of the block cave underground project include decline development, pipelines, conveyors, camp construction, port and roads. Major contracts in support of operations are likely to include: accommodations camp management, building maintenance, underground mine infrastructure development, cave establishment, road maintenance, explosives supply, ground support and consumables supply, material transport and logistics to the preferred port site, infrastructure engineering procurement and construction management, labour training, and infrastructure construction.

Current contracts are typically reviewed and negotiated on a frequent basis. Contract awarding is in accordance to the procurement standard and a delegation of authority process. Based on Newcrest's knowledge, the contract terms are typical of similar contracts both regionally and nationally. It is expected that future contracts will be awarded and negotiated in a similar manner to contracts that are currently in place.

1.19 Capital Cost Estimates

1.19.1 Open Pit

The capital costs for the open pit operations are considered to be sustaining capital and are summarized in Section 1.20.1. As the open pit is operating, the estimated life-of-mine costs are based on actual expenditure as of FY21Q4 and forward-looking estimates.

1.19.2 Block Cave Underground

Capital cost estimates were prepared for the process plant expansions and underground development to produce an estimate with a target accuracy of $\pm 25\%$. Costs were estimated using a bottom-up unit cost and productivity approach, cross-referenced with benchmark data. Footprint mine designs considered haulage scenarios that use single as well as multiple crusher layouts. The reduced distances and the inclusion of a truck loop resulted in a single crusher configuration being selected as the preferred option, substantially reducing the capital required in MB2 and MB3. Capital costs were estimated based on the 13.6 Mt/a Central Case.

The capital cost estimate for the proposed block cave is divided into:

- Initial capital for MB1: includes all expenses up to the completion of underground mine development required to access MB1, material handling systems, and process plant upgrades;
- Initial capital for MB2: includes the incremental underground development capital expenditure required to access this section of the orebody;

- Initial capital for MB3: includes the incremental underground development capital expenditure required to access this section of the orebody;
- Sustaining capital;
- Closure and rehabilitation costs.

The total contingency was C\$396 million or 17.9% of the base estimate for initial capital (including MB 1, MB2 and MB3).

The capital cost estimate from the 2021 PFS on the block cave underground project is summarized in Table 1-5 for the planned underground operation.

1.20 Operating Cost Estimates

1.20.1 Open Pit

The Red Chris open pit is an operating mine with production history. As such, capital costs are treated as sustaining capital operating costs rather than treated as initial capital. The operating costs were estimated during FY21Q4 forecast period and represent the total open pit cost estimate for the remaining LOM (e.g., before the underground block caving operation is fully implemented).

Four major line items make up the open pit operating cost estimate: the processing cost; G&A; sustaining capital operating cost; and the mining cost. The estimated LOM open pit cost forecasts are mining cost at US\$2.90/t mined, milling cost at US\$6.70/t milled, G&A costs at US\$3.30/t milled and sustaining capital at US\$3.60/t milled for an overall process cost of US\$13.60/t processed. These values were used to define the open pit mine plan. Values used for the operating cost estimate will not necessarily match those provided in the economic analysis that has validated the mine plan.

The operating cost estimate for the remainder of the open pit operations is summarized in Table 1-6.

1.20.2 Block Cave Underground

The operating cost estimate is presented at an estimation accuracy of $\pm 25\%$. All inputs were in Q2 2021 Canadian dollars. No escalation was included in the operating cost estimates, nor was a contingency allocation made during estimation.

The basis of the costs for mining operations was developed as part of the integrated mine production plan and schedule, which includes the required number of units of equipment and operators on a monthly basis for the LOM. The labour positions indicated on the mine plan were mapped to the master labour positions, with variable manpower numbers, depending on the mine plan requirements. Mine production equipment costs include maintenance and fuel consumption based on the hourly rates and equipment utilization. Permanent equipment operating costs include maintenance supplies, power, and fuel for all underground systems and infrastructure.

Inputs for these costs were provided by third-party consultants. These costs vary from year to year based on operating parameters.

Table 1-5: 2021 PFS Capital Cost Estimate Summary

Item Estimate (FY22 Real)	Unit	MB1	MB2	MB3	Total
Underground mining (underground mine)	C\$ M	772	179	375	1,326
Raw feed (materials handling)	C\$ M	58	—	—	58
Treatment (plant services & utilities)	C\$ M	157	—	—	157
On-site infrastructure	C\$ M	188	—	—	188
<i>Sub-Total Direct Cost</i>	C\$ M	<i>1,175</i>	<i>179</i>	<i>375</i>	<i>1,729</i>
Construction Indirect costs (support services)	C\$ M	286	19	39	344
Project delivery services	C\$ M	135	10	19	164
Contingency	C\$ M	298	32	66	396
<i>Sub-Total Indirect Cost</i>	C\$ M	<i>719</i>	<i>61</i>	<i>124</i>	<i>903</i>
Total	C\$ M	1,893	240	499	2,632
Indirect	%	61.2	34.0	33.0	52.2
Contingency	%	19.0	15.3	15.2	17.9

Table 1-6: Open Pit LOM Operating Cost Forecast

Type	Units	Total	FY22	FY23	FY24	FY25	FY26	FY27	FY28
Exchange rate	US:CAN		0.80	0.80	0.80	0.80	0.80	0.80	0.80
Tonnes moved	Mt	227.4	46.8	43.9	43.8	40.1	37.4	14.5	0.9
Tonnes milled	Mt	75.0	10.5	11.0	11.0	11.0	11.0	11.0	9.6
Mining Cost	US\$/t	2.9	3.1	3.2	2.5	2.7	2.8	2.8	1.2
Milling	US\$/t	6.7	6.9	6.5	6.3	6.3	6.3	7.2	7.2
G&A	US\$/t	3.3	4.7	3.7	3.6	3.5	3.3	2.2	1.9
Sustaining capital	US\$/t	3.6	8.5	7.0	2.3	2.3	2.2	1.6	1.6
Processing + G&A + Sustaining Capital Cost	US\$/t	13.6	20.1	17.3	12.3	12.0	11.8	10.9	10.7

The process area assumed a personnel count of 105, including management, technical services, and operators. Equipment maintenance and power costs for the existing process plant were based on a nominal process capacity of 11 Mt/a, cost estimates, and FY23 operating budget forecasts. Equipment maintenance and power costs for the new process plant operations were based on a 13.6 Mt/a throughput rate. Reagents and consumables costs for the process plant were jointly developed by a third-party consultant and the Red Chris Operations.

The TIA operating cost includes allocations for personnel, and tailings and reclaim equipment maintenance and power costs.

Infrastructure costs include all maintenance personnel for above-ground facilities, including process plant, infrastructure, ancillary buildings, tailings equipment, and site services. Maintenance and power costs for existing infrastructure were based on the FY23 forecast operating budget. Maintenance and power costs for new infrastructure were based on third-party estimates. Allocations were made for propane and water and sewage treatment.

General and administrative costs were estimated based on the FY23 operating budget, and included allocations for personnel (e.g., management, administration, human resources, health and safety, and other areas), fuel, and power.

The operating cost estimate from the 2021 PFS is summarized in Table 1-7. The annual average operating cost estimate for underground ore in the 2021 PFS totals C\$271 M. On a cost per tonne milled basis, mining costs average C\$5.65, process costs average C\$10.36, and site G&A costs average C\$4.33, for a total LOM average cost of C\$20.34

1.21 Economic Analysis

1.21.1 Forward-Looking Statements

This economic analysis includes forward-looking statements. Forward-looking statements can generally be identified by the use of words such as “may”, “will”, “expect”, “intend”, “plan”, “estimate”, “anticipate”, “continue”, “outlook” and “guidance”, or other similar words and may include, without limitation, Mineral Resource and Mineral Reserve estimates, statements regarding plans, strategies and objectives of management relating to the Project including the proposed mine plan, projected mining and process recovery rates and assumptions as to mining dilution, anticipated production or construction commencement dates, expected costs or production outputs and assumptions as to closure costs and requirements; assumptions as to environmental, permitting and social risks. Forward-looking statements inherently involve known and unknown risks, uncertainties and other factors that may cause the actual results, performance and achievements of the Project to differ materially from statements in this analysis. Relevant factors may include, but are not limited to, changes in external economic factors such as commodity prices, foreign exchange fluctuations, interest rates and tax rates, unanticipated changes in sustaining and operating costs, unexpected variations in the quantity of mineralised material, grade or recovery rates, unexpected changes in the environmental or in geotechnical or hydrological conditions, a failure of mining methods to operate as anticipated, a failure of plant, equipment or processes to operate as anticipated, and the risks relating to permitting, licensing and maintaining a social license to operate.

The production schedules and financial analysis annualised cash flow table are presented with conceptual years shown. Years shown in these tables are for illustrative purposes only. Additional mining, technical, and engineering studies requested as part of the permitting process may result in changes to the project timelines presented.

1.21.2 Methodology Used

The Red Chris Operations, consisting of the open pit and proposed block cave were valued using a discounted cash flow (DCF) approach. Estimates were prepared for all the individual elements of cash revenue and cash expenditures.

The resulting net annual cash flows are discounted back to the date of valuation of start-of-year 30 June 2021. A discount rate of 4.50% was used. Red Chris Operations economics are presented on a 100% basis. Newcrest holds a 70% interest in the project.

Table 1-7: Operating Cost Estimate, 2021 PFS (by area)

Area	Description	Cost per Tonne (C\$/t milled)
200	Underground mining (Underground Mine)	5.44
300	Raw feed (materials handling)	0.21
400	Treatment (plant services & utilities)	7.10
500	On-site infrastructure	3.26
800	General & administrative	4.33
900	Operating contingency	—
	Total	20.34

Note: numbers have been rounded. Totals may not sum due to rounding.

The economic evaluation used the Mineral Reserves summarized in Table 1-3, which support a mine life of 36 years, from FY22 to FY57. Over the LOM, copper recoveries will range from approximately 81–86% and gold recoveries will range from 60–75%. The average concentrate grade over the LOM is forecast at approximately 24.4% Cu. Royalty provisions in the financial model include provisions made to the Tahltan Nation on the five mining leases under the IBCA, and a 1% NSR payable to Royal Gold on all or portions of four of the mining leases. Federal income tax is levied at a rate of 15% on taxable income and provincial income tax in BC is levied at a rate of 12%, resulting in a combined tax rate of 27%. The BC minerals tax was included, as were closure costs of C\$181 M. The base case economic analysis assumes 100% equity financing and is reported on a 100% project ownership basis. Newcrest holds a 70% interest in the Red Chris Operations, and Imperial holds the remaining 30% interest.

1.21.3 Cashflow Results

The economic analysis for the combined open pit and block cave underground project shows a net present value at 4.5% of C\$2,242 M, and an internal rate of return of 16.1%. A payback period of 3.2 years is based on the earliest date that net accumulated free cash flow is equal to zero. This is calculated from first commercial production that is defined as the date of achieving critical hydraulic radius for the Red Chris block cave, which is assumed to be FY27. All metrics are presented prior to shareholder loans.

Table 1-8 presents the financial metrics for the Red Chris Operations.

1.21.4 Sensitivity Analysis

A deterministic point-estimate sensitivity analysis was conducted on each of the key project variables and value drivers. The sensitivity analysis reflects the changes in IRR (%) and NPV (C\$ M) for the corresponding individual movement in each factor.

The Red Chris Operations, including the proposed block cave, are most sensitive to changes in the copper price, less sensitive to changes in the gold price, copper grade, capital costs, gold grade, foreign exchange, gold recovery, copper recovery and least sensitive to changes in operating costs.

Table 1-8: Project Financial Metrics

Scenario	Unit	LOM Total
NPV	C\$m real	2,242
IRR	%	16.1
Payback (from 30 June 2021)	Years	8.9
Undiscounted cumulative cashflow	C\$m real	5,016
Mine life	Years	36
Open pit mined (ore + waste)	Mt	200
Underground mined	Mt	406
Tonnes moved	Mt	654
Tonnes milled	Mt	471
Gold grade	g/t	0.53
Copper grade	%	0.45
Gold production	koz	5,321
Copper production	kt	1,749
AISC	C\$/oz	(60)
AIC	C\$/oz	458
Site costs	C\$/t milled	21.01
Sustaining capital cost estimate	C\$m real	1,761
Production stripping	C\$m real	372
Exploration	C\$m real	99
Non-sustaining capital cost estimate	C\$m real	2,758
Total capital cost estimate	C\$m real	4,991

Notes: AISC = all-in sustaining capital costs; AIC = all-in costs. Numbers have been rounded. Totals may not sum due to rounding.

1.22 Risks and Opportunities

A number of risk workshops were conducted during the 2021 PFS.

1.22.1 Risks

Key risks identified are summarized by discipline area:

- Geology:
 - Lower grades encountered in mining. Potentially mitigate by completing additional drilling campaigns, and performing cave flow modelling;
 - Presence of unidentified faulting. Potentially mitigate by completing a structural geology interpretation; evaluation of available data collection including face mapping and digital scanning;

- Mining:
 - Geotechnical risk associated with potential pit wall failure;
 - Increased costs or reduced grades impacting the end of mine life production;
- Seismicity:
 - A seismic event, either from earthquake or mining-related activity, remobilizes the Kluea lake landslide complex that is located to the south of the open pit. Potentially mitigate by completing mine seismicity modelling and the effect of seismic events on infrastructure and local features; evaluate the impact of block cave induced seismicity on the complex; conduct a structural geology interpretation;
- Water balance and water quality:
 - Uncertainty around operational water balance projection that may impact permitting, design and production. Potentially mitigate using data verification by independent review and de-risk option studies, monitoring, and completion of site-specific remediation and mitigation projects;
 - Wells cannot supply sufficient volume of quality raw water to maintain operation. Although current modelling shows that the capacity of the wells is sufficient to support the block cave project, there is a risk that the modelling completed to date is inaccurate. This could be mitigated by conducting the planned hydrogeological surveys and modelling work; monitoring of water usage requirements; implementing seepage reduction measures; minimizing evaporation losses by reducing the pond size; utilizing thickener to increase water usage efficiency, and apply for additional water extraction permits if needed;
 - Uncertainties as to the long-term water quality (e.g. TIA seepage quality). Potentially mitigate by continuous monitoring, using existing extraction wells, installing new seepage interception system, implementing natural remediation measure and installing a water treatment plant if necessary;
- TIA:
 - TIA failure. Potentially mitigate by retaining a third-party engineer with significant experience in BC and with sand tailings dam experience; establishing additional project/corporate/site interface and alignment on third party oversight requirements, regulatory requirements and IBCA commitments; completing assessment of valley dump geotechnical risk; careful management during construction to ensure dam constructed to design;
 - A seismic event, either from earthquake or mining-related activity, causes a TIA failure. Potentially mitigate by completing mine seismicity modelling and the effect of seismic events on infrastructure and local features; conduct a structural geology interpretation; review designs during next study phase;

- Required quantities of borrow materials (till, sand and gravel, rockfill) not available to support dam raises (includes North dam, South dam, Northeast dam and reclaim dams). Potentially mitigate by extensive site investigations identifying borrow materials that are of required quality, accessible, and within an economic distance of the TIA dam construction sites. Manage and maintain consistent sand recovery operations from mine ore feed, to process plant, and to tailings cycloning system to ensure that borrow material requirements do not increase;
- Dam raise assumptions. The 2021 PFS assumes that sufficient inventory of tailings sand will have been accumulated by 2041 to allow for the final embankment raise. This will require the site to achieve the target sand yield at the required quality and quantity. Failure to achieve the yield target would significantly increase embankment construction costs later in the mine life due to the need for additional borrow materials, or alternatively if borrow sources are constrained, may limit the height of the final dams and the associated TIA capacity;
- Closure:
 - There is a risk that closure costs will increase as a result of additional reviews and feasibility study design, resulting from alternative concepts for TIA and RSA covers, water quality controls and post-closure land use;
- Cost estimation:
 - There is a risk that estimates of sustaining capital, non-sustaining capital and operating costs could escalate more than anticipated, due to external economic pressures (e.g. labour shortages in BC, commodity prices, oil, steel, consumables and reagent prices), and/or changes to technical or operational issues underpinning the cost estimates (e.g. water treatments, TIA construction);
- Permitting and contracts:
 - Permitting a block cave operation in BC in the anticipated timeframe. Potentially mitigate by identifying the various government departments and regulations which will govern the approvals process; develop applicable permitting strategies; complete all environmental surveys and supporting studies; engage and consult with Major Mines Office prior to mining proposal submission; identify all potentially interested parties and stakeholders; develop monitoring and mitigation plans;
 - Uncertainties as to assumed timelines to negotiate contracts in support of the planned block cave operations (e.g. contracts deemed to be direct award under the IBCA);
- Human resources:
 - Skilled personnel shortage. Potentially mitigate by monitoring labour market; providing upgraded onsite accommodation; developing strategic partnerships;

1.22.2 Opportunities

Key opportunities are summarized by discipline area:

- Geology:
 - Identification of additional mineralization at higher grades within the known porphyry copper corridor that hosts the Red Chris Operations;
 - Identification of new targets or prospects within the Project area;
- Incorporation of innovative technology in the next study stage:
 - Potential to include state-of-the-art design and technology, such as eccentric rolls crusher, single pass cave establishment, novel cave footprint designs, continuous miner, and autonomous vehicles;
 - Electrification of underground fleet to reduce carbon emissions and improve air quality;
- Use of a dry cover on the TIA to potentially reduce closure costs;
- North dam construction:
 - Once a 300 m or longer beach is established at North dam, as planned, following the relocation of the pump barge to the central location, the dam is no longer considered as a water dam; then the zoned structure can be simplified into a uniform cyclone sand dam similar to the South dam. This change will simplify the construction process and hence increase dam stability, and presents a cost saving.
- Combine NAG/PAG disposal:
 - This opportunity could be realized if the neutralizing potential ratio is above 2 after appropriate and practical mixing of NAG and PAG tailings streams and deposited into the pond. Further study is needed to confirm this potential.

1.23 Interpretation and Conclusions

Under the assumptions in this Report, the Red Chris Operations show a positive cash flow over the life-of-mine and supports the Mineral Reserve estimate. The mine plan is achievable under the set of assumptions and parameters used.

1.24 Recommendations

The QPs prepared a recommended two-phase work program that focuses on an infill drill program in the first phase and work to support feasibility-level studies in the second phase. The phases are independent and can be completed concurrently.

The cost estimate to complete the first phase of the proposed work is a total of about C\$27.6 M. The suggested budget to complete the second work phase is approximately C\$50.2 M.

The Phase 1 program will include:

- Infill resource development drilling program with the aim of potentially upgrading resource confidence classifications in the area from the East Ridge to the western extent of MB3.

The Phase 2 program is based on the planned feasibility study and will include the following key areas:

- Geological modelling
 - A Mineral Resource estimate update;
 - Geometallurgical domain updates;
- Mining and geotechnical studies:
 - Validate in situ stress parameters using the ANZI cell method;
 - Refine the three-dimensional geological and geotechnical models and update rock mass characterizations, focusing on rock types, alteration types, weathering grades, rock quality/strength and major geologic structures;
 - Optimize and refine cave footprint, including assessment of variable shut-off grades;
 - Improve cave monitoring system design using both microseismic and cave beacons;
 - Update hydrogeological models and inflow assessments;
 - Refine preconditioning assessment and validate fragmentation analysis;
 - Complete a hill-of-value style site production rate assessment;
 - Complete detailed engineering and optimisation of the material handling system;
 - Complete detailed ventilation design and engineering;
 - Optimise the transition between macro blocks;
 - Evaluate potential to have mine fully electric;
- Metallurgy and processing:
 - Geotechnical site investigations in the plant upgrade footprint;
 - Laser scan within the existing mill building to assist with equipment and piping placement;
 - Metallurgical variability testwork;
- Tailings and water management:
 - Geotechnical and hydrogeological site investigation for dams, reclaim dams and diversion ditch modifications;
 - Characterization of future borrow sources;
- Infrastructure:

-
- Site investigations for road upgrades, new operations accommodation complex and vent raise;
 - Assessment of quarry rock for use for concrete aggregate;
 - Asset integrity assessment;
 - Traffic study;
 - Power efficiency studies;
 - Investigations to secure additional concentrate storage capacity at Stewart Bulk Terminals;
 - Permitting:
 - Further integration of the block cave development schedule into the permitting process;
 - Engagement and consultation with the Tahltan Nation and provincial and federal regulatory agencies;
 - Environmental, social and cultural heritage:
 - Completion of supporting studies in the areas of dust, noise, and air quality to assess the impacts of potential incremental Project increases;
 - Closure studies to reduce risks associated with long-term water (quantity and quality) and metals leach/acid rock drainage management post-closure;
 - Engagement and consultation with the Tahltan Nation on closure aspects.

2 INTRODUCTION

2.1 Introduction

Newcrest Mining Limited (Newcrest) has prepared this Technical Report (the Report) on the Red Chris Operations (Red Chris Operations or the Project), in British Columbia (BC), Canada. The Project location is shown in Figure 2 1.

The Red Chris Operations are managed by an unincorporated joint venture, the Newcrest Red Chris Joint Venture, between Newcrest Red Chris Mining Limited, a wholly-owned Newcrest subsidiary, and Red Chris Development Company Ltd. a wholly-owned subsidiary of Imperial Metals Corporation (Imperial). Newcrest has a 70% joint venture interest through Newcrest Red Chris Mining Limited, and is Project manager, and Imperial has a 30% interest.

The Red Chris Operations are an open pit operation, with an annual throughput rate of about 10–11 Mt/a. Newcrest plans to transition to a block cave underground mining operation that will produce 13.6 Mt/a. This Report discusses the remaining open pit life-of-mine (LOM) plan, and the results of the “Red Chris Block Cave Pre-Feasibility Study” (the 2021 PFS) evaluating the proposed block cave (the block cave project).

2.2 Terms of Reference

This Report supports Newcrest’s disclosures in the news release dated 12 October, 2021, entitled “Red Chris Block Cave Pre-Feasibility Study confirms Tier 1 potential”.

The Report also supports Imperial’s disclosures in the news release dated 11 October, 2011, entitled “Red Chris Block Cave Pre-Feasibility Study Confirms Low Cost, Long Life”.

For the purposes of this Report, the name Newcrest is used interchangeably for the Newcrest parent, Newcrest operating subsidiary and the Newcrest Red Chris Joint Venture.

All measurement units used in this Report are metric unless otherwise noted, and currency is expressed in United States (US\$) or Canadian (C\$) dollars as identified in the text. Cost estimates for the open pit operations are generally reported in US\$, and the 2021 PFS costs for the proposed block cave project are typically in C\$.

Mineral Resources and Mineral Reserves were initially classified using the 2012 edition of the Australasian Joint Ore Reserves Committee (JORC) Code (2012 JORC Code). The confidence categories assigned under the 2012 JORC Code were reconciled to the confidence categories in the Canadian Institute of Mining, Metallurgy and Petroleum (CIM) Definition Standards for Mineral Resources and Mineral Reserves (May 2014; the 2014 CIM Definition Standards). As the confidence category definitions are the same, no modifications to the confidence categories were required. Mineral Resources and Mineral Reserves in this Report are reported in accordance with the 2014 CIM Definition Standards.

Figure 2-1: Red Chris Operations Location Plan

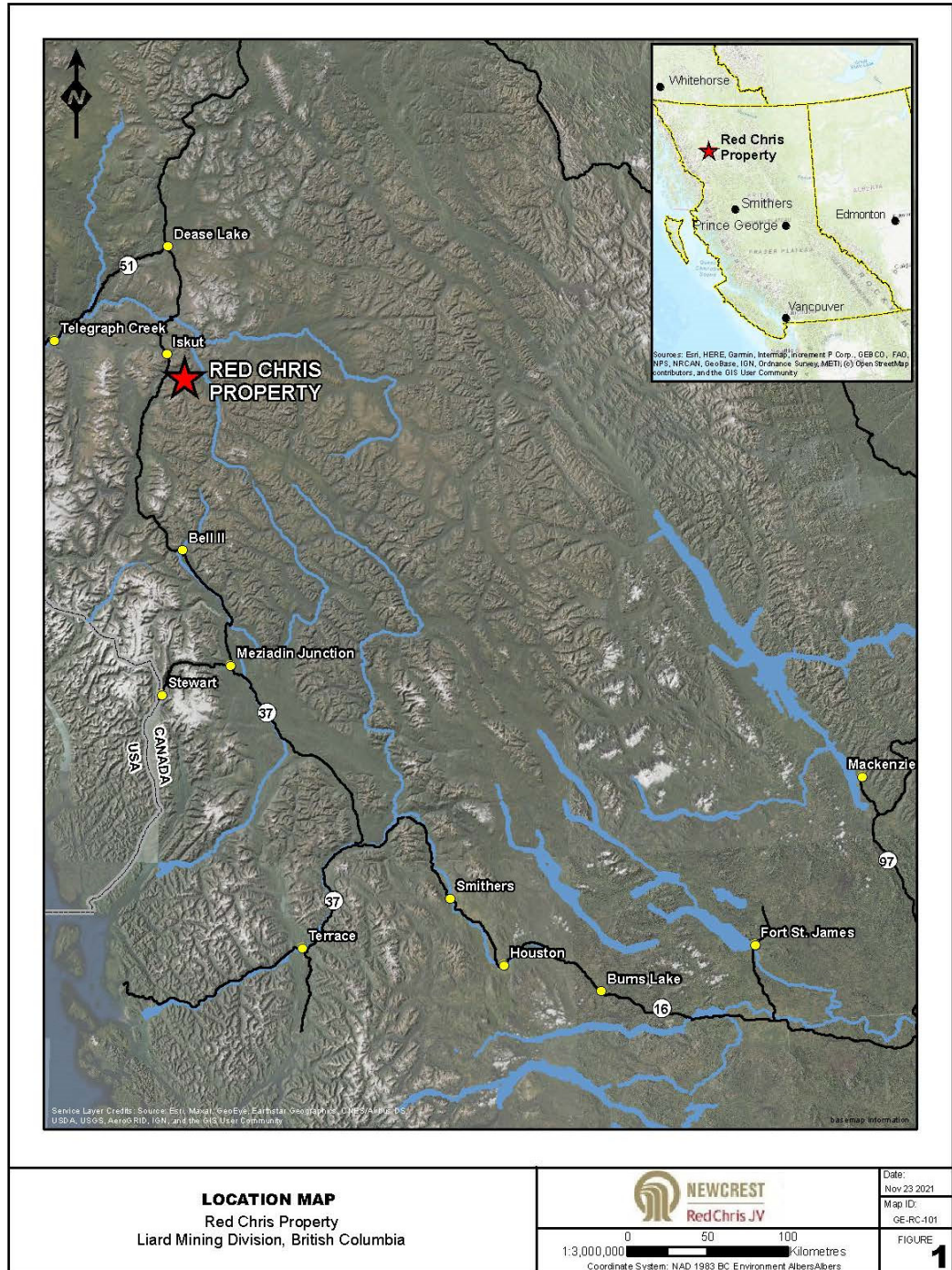

Note: Figure prepared by Newcrest, 2021.

The Mineral Reserves are forward-looking information and actual results may vary. The risks regarding Mineral Reserves are summarized in the Report (see Section 15.5 and Section 25). The assumptions used in the Mineral Reserve estimates are summarized in the footnotes of the Mineral Reserve table and outlined in Section 15 and Section 16 of the Report.

2.3 Qualified Persons

This Report has been prepared by the following Newcrest Qualified Persons (QPs):

- Mr. Robert (Rob) Stewart, FAusIMM, Group Manager Resources;
- Mr. Brett Swanson, MMSAQP, Principal Open Pit Planning Engineer;
- Mr. Michael Sykes, FAusIMM, Mining Study Manager;
- Mr. Laurie Reemeyer, P.Eng., Process and Tailings Lead – Red Chris Block Cave Project;
- Dr. Bing Wang, P.Eng., Tailings Operations Manager, Red Chris Mine;
- Mr. Philip Stephenson, FAusIMM, Chief Operating Officer, Australia and Americas.

2.4 Site Visits and Scope of Personal Inspection

Mr. Rob Stewart visited the site from April 4–11, 2019, under the supervision of Mr. Jim Miller-Tait, P.Geo. During this site visit Mr. Stewart inspected the open pit mining operations, reviewed the resource reconciliation performance of the mining operations at the time of the visit, observed collection of ore control samples, visited the on-site laboratory facilities, visited the coreshack, inspected historical drill core, and visited near mine exploration areas. The site visit included discussion of the geological interpretation at both resource and ore control scales

Mr. Michael Sykes visited the Red Chris Operations most recently from 16–19 November 2019, under the supervision of Mr. Laurie Reemeyer, P.Eng. Mr. Sykes has been involved with the Red Chris Block Cave Project since August 2019 as the Mining Lead for the underground studies. During this visit, he inspected open pit, drill core and logging facilities, the process plant and the exploration decline boxcut and laydown areas for site suitability. The visit also incorporated communications with site personnel to integrate site specific requirements into the underground planning process.

Mr. Laurie Reemeyer most recently visited the Red Chris Operations from 14–20 September, 2021, and prior to that visit, had been to site from 13–16 September, 2019, 16–19 November, 2019, 13–16 July, 2020, and 26–29 October 2020. Mr. Reemeyer has been involved with the Red Chris Block Cave Project since August 2019 in roles including Concept Study Manager and subsequently, Process and Tailings Lead. He has visited the Red Chris Operations on five occasions. During his visits in October 2020 and September 2021, he inspected the process plant and the adjacent areas where proposed plant upgrades will be located, met with metallurgical staff to discuss plans and layouts for the modifications to the process plant, and visited the tailings impoundment area, including operations to produce cyclone sand for dam construction. He has assisted with

interpretation of metallurgical test results from underground core samples and flowsheet development and equipment selection for the block cave process plant upgrades.

Dr. Bing Wang has worked for Newcrest since 7 December 2020 and has been based at Red Chris Mine as a Responsible Tailings Facility Engineer since that time to the technical report effective date, on a week-on-week-off roster. He has held the role of Tailings Operation Manager and has the overall responsibility for the planning and execution of annual tailings dams raising construction, tailings and reclaim ponds operation, seepage control and water management in consultation with the Engineer of Record, as well as budgeting preparation. Dr. Wang also facilitates the Independent Engineering Review Panel review work in liaison with Newcrest's Head of Tailings.

Mr. Philip Stephenson most recently visited the Red Chris Operations from 18-13 November 2021, and prior to that visit, had been to site five times in 2019 before the start of the COVID pandemic which prevented overseas business travel between Australia and British Columbia until late 2021. The previous visits occurred on 31 Jan–1 February, 2019 as part of the due diligence team, visits from 11–15 March, 2019 and 4–6 April, 2019 as the Integration Sponsor for the project, and post-acquisition visits from 16–21 August 2019 and 3–6 November 2019 as COO, Australia and Americas and, as such, the responsible executive for Red Chris for Newcrest. During his visits in 2019, he was under the supervision of Mr. Jason Corlazzoli, P.Geol., and during the 2021 site visit, he was under the supervision of Mr. Benjamin David, P.Eng. During the 2019 and 2021 visits, Mr. Stephenson inspected the open pit mine, the process plant, the tailings impoundment area, maintenance facilities, the warehouse, and exploration facilities. The site visits also included discussions with site management on health and safety, environmental management, social performance, operations, exploration, and engagement with Tahltan leadership and external stakeholders.

2.5 Effective Dates

There are a number of effective dates pertinent to the Report, as follows:

- Latest information on the ongoing exploration program: 30 September, 2021;
- Exploration database close-out date for Mineral Resource estimates: 8 February, 2021;
- Effective date of the Mineral Resource estimates: 30 June, 2021;
- Effective date of the Mineral Reserve estimates: 30 June, 2021;
- Date of the economic analysis that supports Mineral Reserve estimation: 30 June, 2021.

The overall Report effective date is taken to be 30 June, 2021; and is based on the effective date of the Mineral Reserve estimate and economic analysis that supports the Mineral Reserves.

2.6 Information Sources and References

This Report is based, in part, on internal company reports, maps, published government reports and public information, as listed in Section 27 of this Report.

The primary data source is the 2021 PFS:

- Newcrest, 2021: Red Chris JV, Block Cave Project, Pre-feasibility Study: report prepared for the Red Chris Joint Venture, 16 vols, October, 2021.

The following Newcrest employees contributed to various aspects of the Report under the supervision of the QPs:

- Ms. Lisa Bowyer, Manager Land Tenure, one year of experience with the Project;
- Mr. Ryden Jakovljevic-Runco, Senior Business Analyst, FP&A, one year of experience with the Project;
- Ms. Kyoko Sasahara, Manager Marketing and Logistics, two years of experience with the Project;
- Ms. Michelle Fulcher, Group Manager Cultural Heritage, one year of experience with the Project;
- Ms. Marina Bravo Foster, Senior Environmental Projects and Approvals, one year of experience with the Project;
- Vincent Maddalozzo, Infrastructure Lead, one year of experience with the Project;
- Nicholas Fitzpatrick, Manager Exploration, one year of experience with the Project;
- Mr. Bosta Pratama, Principal Resource Geologist, one year of experience with the Project;
- Mr. Donovan Munro, Study Manager, one year of experience with the Project;
- Mr. Eric Strom, Head of Studies, one year of experience with the Project;
- Mr. Ben Wither, Manager HSEC and Permitting, one year of experience with the Project;
- Ms. Jill Terry, Head of Mineral Resource Management, two months of experience with the Project.

All figures were prepared by Newcrest personnel for the Report unless otherwise noted.

2.7 Previous Technical Reports

Newcrest has not previously filed any technical reports on the Red Chris Operations.

Prior to Newcrest obtaining its Project interest, Imperial had filed the following technical reports:

- Gillstrom, G. and Robertson S., 2010: Red Chris Deposit Technical Report: 2010 Exploration, Drilling and Mineral Resource Update: technical report prepared for Imperial Metals Corporation, effective date 19 May, 2010;
- Gillstrom, G., Anand R. and Robertson S., 2011: 2011 Technical Report on the Red Chris Copper-Gold Project: 2011 Feasibility Study, Exploration, Drilling and Mineral Reserve/Resource Update: technical report prepared for Imperial Metals Corporation and American Bullion Minerals Ltd., effective date 14 March, 2011;

- Gillstrom, G., Anand, R., Robertson, S., and Sterling, P., 2015: 2012 Technical Report on the Red Chris Copper-Gold Project: technical report prepared by Imperial Metals Corporation, effective date 14 February 2012, restated and amended as at 30 September, 2015.

Prior to Imperial's ownership, the following technical report was filed:

- Collins, J., Colquhoun, W., Giroux, G.H., Nilsson, J.W., and Tenney, D., 2004: Technical Report on the Red Chris Copper-Gold Project, Liard Mining Division: technical report prepared for Red Chris Development Company Ltd. and bcMetals Corporation, effective date 16 December, 2004.

3 RELIANCE ON OTHER EXPERTS

This section is not relevant to this Report.

4 PROPERTY DESCRIPTION AND LOCATION

4.1 Introduction

The Red Chris Operations are a copper–gold open pit mining operation located in northwest British Columbia, Canada, approximately 18 km southeast of the Iskut village, 80 km south of Dease Lake, and 12 km east of the Stewart-Cassiar Highway 37.

The Project is located at approximately 57° 44' N, 129° 45' 30" E.

4.2 Property and Title in British Columbia

The Ministry of Energy, Mines and Low Carbon Innovation is largely responsible for the mining sector. The Ministry of Environment and Climate Change Strategy, the Environmental Assessment Office and the Ministry of Forests, Lands, Natural Resource Operations and Rural Development provide for additional oversight of mining operations through their respective mandates. Applicable legislation and regulation in British Columbia includes:

- *Mineral Tenure Act* (MTA);
- *Land Act*;
- *Mines Act* (and the accompanying Health, Safety and Reclamation Code for Mines in British Columbia);
- *Mineral Land Tax Act*;
- *Mineral Tax Act*;
- *Environmental Assessment Act*;
- *Environmental Management Act*.

Rights to mineral resources on public lands are generally held by the Crown. The ownership of lands and minerals situated in a province generally belong to the province. Each provincial government exercises administration and control of ownership and disposition of most mining rights and lands through provincial legislation.

4.2.1 Mineral Title

Prior to 1 June 1991, registrations in respect of a mineral claim or mining lease were manually recorded on, or attached to, the original application document for a mineral claim or the original lease document for a mining lease. From June 1991 to 11 January 2005, all records were entered into a computer database, maintained by the Gold Commissioner's Office. On 12 January 2005, the British Columbia mineral titles system was converted to an online registry system, MTO, and ground-staking of claims was eliminated in favour of map-staking based on grid cells. Claims recorded prior to 12 January 2005 are referred to as legacy claims. Claims acquired through map staking are referred to as cell claims. From and after the date of changeover to map-staking, claim holders could convert legacy claims to cell claims, or maintain the original legacy

claim. Legacy claims vary in size and shape, depending on the regulations that were in force at the time of staking and recordation.

Cell claims can consist of 1–100 cells which range from 21 ha in southern British Columbia to 16 ha in the north.

A mineral claim is valid for one year and can be extended for as many as 10 years from the application date or on a year-to-year basis. The extension period depends on whether the claimholder has opted to undertake work on the property or make payment in lieu.

To keep claims in good standing in accordance with the MTA, a minimum value of work or cash-in-lieu is required annually. The minimum value of work required to maintain a legacy or cell mineral claim for one year is currently set at \$5/ha for the first and second anniversary years, \$10/ha for the third and fourth anniversary years, \$15/ha in the fifth and sixth anniversary years, and \$20/ha for each subsequent anniversary year. The cash-in-lieu required to maintain a mineral claim for an anniversary year is double the value of the work commitment requirement.

A mining lease is required if the claim holder wishes to produce more than 1,000 t of ore in a year from each unit in a legacy claim (typically 25 ha) or each cell in a cell claim. The holder of a mineral claim may obtain a mining lease for that claim if certain requirements are met (surveying if required, payment of fees, and posting of notices).

Unpatented mineral claims must generally be converted into mineral leases before production-level activities and resource extraction can occur. To convert an unpatented mineral claim to a mineral lease in British Columbia, the claimholder must register an application for a mining lease with the province's mineral titles registry and pay a prescribed fee. The claimholder must then post a notification in the province's Gazette and in a newspaper circulating within the area of the claim, and the BC government requires that the mineral claims be surveyed by a land surveyor.

Mineral leases are generally granted for terms that may range from 10–30 years. The initial term of a mineral lease cannot exceed 30 years. A lessee can renew for a period of a maximum of 30 years if the lessee complies with the *Mineral Tenure Act*.

4.2.2 Surface Rights

The holder of a mineral claim or mining lease issued under the *Mineral Tenure Act* does not have exclusive possession of the surface or exclusive right to use the surface of the land. However, the holder of such claims and leases does have the right to access the lands for the purpose of exploring for minerals and to use the surface for mining activities (exploration, development, and production).

The surface of a mineral claim or mining lease may either be privately owned or owned by the Crown. The *Mineral Tenure Act* provides for a recorded claim holder to use, enter and occupy the surface of a claim for the exploration and development or production of minerals, including the treatment of ore and concentrates, and all operations related to the exploration and development or production of minerals and the business of mining, subject to production limits. Permits are required before undertaking most exploration or mining activity.

A recorded claim holder must give surface owners of private land and leaseholders of Crown land notice before entering for any mining activity. A recorded holder is liable to compensate the surface owner for loss or damage caused by the entry, occupation or use of the area for exploration and development or production of minerals.

4.2.3 Environmental Regulations

The Environmental Assessment Act provides a mechanism for reviewing proposed major projects in British Columbia, including major mining projects, to assess their potential impacts. The Environmental Assessment Office (EAO) manages the assessment of proposed major projects as required by the *Environmental Assessment Act*.

Certain large-scale project proposals must undergo an Environmental Assessment (EA) and obtain an EA certificate before they can proceed; an Application must be prepared for an EA certificate which identifies and assesses any potential effects that may result from the proposed project, and ways to mitigate any adverse effects where possible. Federally, this information is compiled into an Environmental Impact Statement (EIS). Under a joint EA process, the proponent submits one document that meets the requirements of both governments.

If the project is allowed to proceed, an EA certificate is issued and is subject to compliance and reporting requirements. The EA certificate specifies a deadline by which the project must have substantially commenced and is generally at least three years and not more than five years after the issue date of the Certificate. Once the project has substantially started, the EA certificate remains in effect for the life of the project unless suspended or cancelled for breaches of the conditions. Proponents may apply to amend their EA certificate as project circumstances change.

4.2.4 Water Regulations

All water in British Columbia is owned by the Crown on behalf of the residents of the province. There are authorized uses of water outside of the licensing system, such as the use of groundwater for domestic purposes. All other ground or surface water uses, including for mining, require a license.

The Ministry of Forests, Lands, Natural Resource Operations & Rural Development (FLNRORD) authorizes licences and approvals, and holders must comply with provincial, local and in some cases federal regulations. Separate licenses are required for all non-domestic uses of surface and ground water. The licence contains the terms of use, including the quantity that can be taken, the purpose for which the water will be used, and the time of year that water can be harvested. Water licences are subject to a compulsory review after a 30-year period.

4.2.5 Royalties

Under the *Mineral Tax Act* in British Columbia, operators pay tax at the following rates:

- 13% of the net revenue proceeds derived from the operations of a mine for the current fiscal year;
- 2% of the net current proceeds derived from the operations of a mine for the current fiscal year.

The owners of mineral lands under the *Mineral Land Tax Act* also pay an annual tax on mineral lands regardless of whether minerals are produced from that land. The tax amount depends on the size of the mineral lands. In British Columbia, the rate ranges between C\$1.25/ha (up to 20,235 ha) and C\$4.94/ha (more than 404,686 ha).

4.2.6 Indigenous Peoples

The status of Indigenous land rights and land holdings must be considered when acquiring mineral rights in Canada. "Indian reserve" lands under the *Indian Act* are subject to a unique federal regulatory process. Over the past few decades, Canada has entered into modern treaties with many Indigenous groups which transferred mineral rights ownership in certain prescribed lands in consideration of surrender of title on broader areas of Crown lands. Extracting minerals from these treaty lands typically requires the consent of the rights-owning Indigenous group.

4.2.7 Fraser Institute Survey

The QP used the 2020 Fraser Institute Annual Survey of Mining Companies report (the 2020 Fraser Institute Survey) as a reasonable source for the assessment by peers in the mining industry of the overall political risk facing an exploration or mining project in British Columbia. Each year, the Fraser Institute sends a questionnaire to selected mining and exploration companies globally. The Fraser Institute survey is an attempt to assess how mineral endowments and public policy factors such as taxation and regulatory uncertainty affect exploration investment.

The QP used the 2020 Fraser Institute survey because it is globally regarded as an independent report-card style assessment to governments on how attractive their policies are from the point of view of an exploration manager or mining company and forms a proxy for the assessment by industry of political risk in specific political jurisdictions from the mining industry's perspective.

Of the 77 jurisdictions surveyed in the 2020 Fraser Institute survey, British Columbia ranks 17th for investment attractiveness, 41st for policy perception and 10th for best practices mineral potential.

4.3 Project Ownership

The Project is 70% owned by Newcrest Red Chris Mining Limited, a wholly-owned Newcrest subsidiary, and 30% owned by Red Chris Development Company Ltd., an Imperial subsidiary. The operating entity is the unincorporated Newcrest Red Chris Joint Venture. Newcrest, through Newcrest Red Chris Mining Limited, is operator.

4.4 Mineral Tenure

The mineral tenure is registered 100% to Newcrest Red Chris Mining Limited.

The Project comprises the Red Chris Main claim group and the Red Chris South claim group. The two groups collectively consist of 77 mineral tenures covering a total area of approximately 23,142 ha.

A layout plan of the claim locations is provided in Figure 4-1, and the claim details are summarized in Table 4-1 for the Red Chris Main claims and Table 4-2 for the Red Chris South claims.

The main tenures for purposes of the LOM plan are five mining leases issued on 20 June 2012, for a term of 30 years, with an expiry date of 20 June 2042 (Figure 4-2). The location of the key infrastructure that is envisaged in the 2021 PFS is shown in relation to the lease boundaries in Figure 4-3.

A rent payment for each mining lease is required by 20 June each year to keep the leases in good standing. The leases are currently in good standing until 20 June 2022.

As part of the 2021 PFS, the proposed South Reclaim dam (see discussion in Section 18) may need to be constructed on a portion of lands occupied by Mineral Claim 541621. The *Mineral Tenure Act* appears to provide mineral claim holders with sufficient rights to use the surface for this purpose. However, permitting authorities typically require that an applicant holds a mining lease or surface tenure before granting authority to carry out surface operations of this nature. Newcrest intends to apply to convert Mineral Claim 541621 to a mining lease in advance of applying for the amendment to Mines Act Permit M-240 and EMA Permit 105017 (see discussion in Section 20.5), and an amendment to the site occupational licence to cut to perform work on lands covered by Mineral Claim 541621.

4.5 Surface Rights

All land in the immediate vicinity of the Red Chris Operations is Crown land. Surface rights to support the open pit operations are permitted by the granted Environmental Assessment Certificate and the Mines Act permit M-240 (see Section 20.5). Permit amendments would be required to support planned underground mining activities.

Newcrest Red Chris Mining Limited holds the following surface tenure issued by FLNRORD under the *Land Act* (RSBC 1996, c. 245):

- Right-of-way tenure number 6408389 over 68.95 ha of unsurveyed Crown land in the vicinity of Jackson Creek, Coyote Creek, Ealue Lake, and a portion of District Lot 2977, on which a portion of the Red Chris power line is located. This tenure was issued on 14 July 2018 and has an expiry date of 14 July 2024. The tenure can be renewed prior to its expiry by submitting a renewal application to FLNRORD.

Newcrest submitted an application to extend the duration of the occupational licence to cut; this is currently under review by FLNRORD and the Tahltan Central Government.

Figure 4-1: Red Chris Mineral Tenure Map

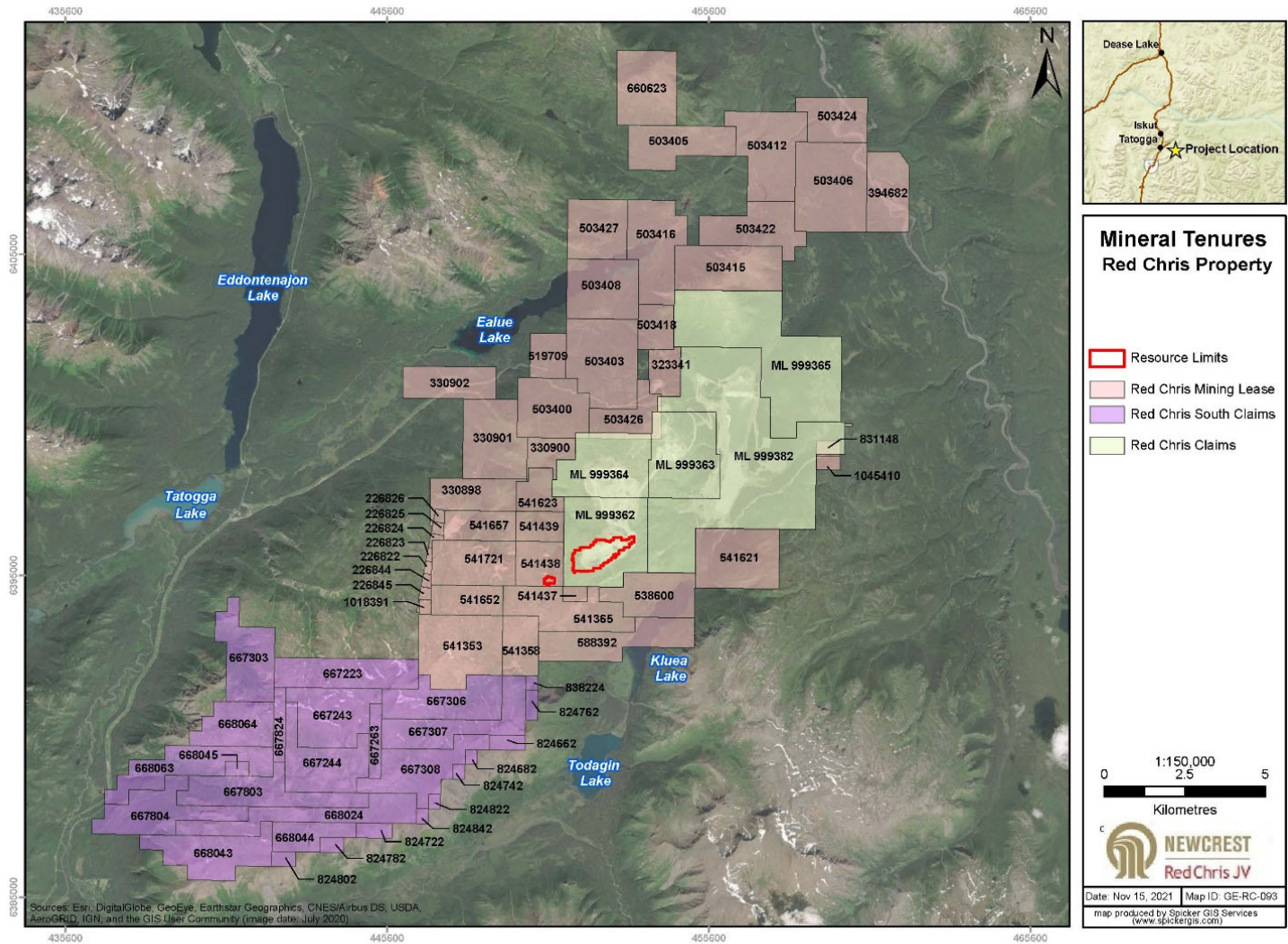

Table 4-1: Red Chris Main Block Claims

Title Number	Title Type	Issue Date	Good To Date	Expiry	Area (ha)
999362	Mining Lease	20-Jun-12	20-Jun-22	20-Jun-42	691.0
999363	Mining Lease	20-Jun-12	20-Jun-22	20-Jun-42	573.0
999364	Mining Lease	20-Jun-12	20-Jun-22	20-Jun-42	546.0
999365	Mining Lease	20-Jun-12	20-Jun-22	20-Jun-42	1254.0
999382	Mining Lease	20-Jun-12	20-Jun-22	20-Jun-42	2077.0
226822	Mineral Claim	30-Sep-68	31-Oct-22	N/A	69.2
226823	Mineral Claim	30-Sep-68	31-Oct-22	N/A	121.9
226824	Mineral Claim	30-Sep-68	31-Oct-22	N/A	17.3
226825	Mineral Claim	30-Sep-68	31-Oct-22	N/A	500.0
226826	Mineral Claim	30-Sep-68	31-Oct-22	N/A	500.0
226844	Mineral Claim	30-Sep-68	31-Oct-22	N/A	500.0
226845	Mineral Claim	30-Sep-68	31-Oct-22	N/A	500.0
306685	Mineral Claim	30-Sep-68	31-Oct-26	N/A	500.0
323341	Mineral Claim	16-Jan-94	31-Oct-26	N/A	500.0
330898	Mineral Claim	11-Sep-94	31-Oct-26	N/A	450.0
330900	Mineral Claim	11-Sep-94	31-Oct-26	N/A	450.0
330901	Mineral Claim	12-Sep-94	31-Oct-26	N/A	500.0
330902	Mineral Claim	13-Sep-94	31-Oct-26	N/A	500.0
394682	Mineral Claim	18-Jun-02	31-Oct-26	N/A	311.7
503400	Mineral Claim	14-Jan-05	31-Oct-26	N/A	415.2
503403	Mineral Claim	14-Jan-05	31-Oct-26	N/A	415.2
503405	Mineral Claim	14-Jan-05	31-Oct-26	N/A	415.2
503406	Mineral Claim	14-Jan-05	31-Oct-26	N/A	415.2
503408	Mineral Claim	14-Jan-05	31-Oct-26	N/A	259.5
503412	Mineral Claim	14-Jan-05	31-Oct-26	N/A	433.2
503415	Mineral Claim	14-Jan-05	31-Oct-26	N/A	364.1
503416	Mineral Claim	14-Jan-05	31-Oct-26	N/A	433.5
503418	Mineral Claim	14-Jan-05	31-Oct-26	N/A	433.5
503422	Mineral Claim	14-Jan-05	31-Oct-26	N/A	433.5
503424	Mineral Claim	14-Jan-05	31-Oct-26	N/A	398.8
503426	Mineral Claim	14-Jan-05	31-Oct-26	N/A	433.5
503427	Mineral Claim	14-Jan-05	31-Oct-26	N/A	433.7
519709	Mineral Claim	6-Sep-05	31-Oct-26	N/A	347.2
538600	Mineral Claim	3-Aug-06	31-Oct-26	N/A	399.7
541353	Mineral Claim	15-Sep-06	31-Oct-26	N/A	434.7

Title Number	Title Type	Issue Date	Good To Date	Expiry	Area (ha)
541358	Mineral Claim	15-Sep-06	31-Oct-26	N/A	434.7
541365	Mineral Claim	15-Sep-06	31-Oct-26	N/A	434.7
541437	Mineral Claim	15-Sep-06	31-Oct-26	N/A	434.7
541438	Mineral Claim	15-Sep-06	31-Oct-26	N/A	434.9
541439	Mineral Claim	15-Sep-06	31-Oct-26	N/A	434.9
541621	Mineral Claim	19-Sep-06	31-Oct-26	N/A	434.9
541623	Mineral Claim	19-Sep-06	31-Oct-26	N/A	435.0
541652	Mineral Claim	19-Sep-06	31-Oct-26	N/A	435.2
541657	Mineral Claim	19-Sep-06	31-Oct-26	N/A	435.2
541721	Mineral Claim	19-Sep-06	31-Oct-26	N/A	435.2
588392	Mineral Claim	17-Jul-08	31-Oct-26	N/A	418.0
660623	Mineral Claim	27-Oct-09	31-Oct-26	N/A	418.0
831148	Mineral Claim	5-Aug-10	31-Oct-22	N/A	17.3
1018391	Mineral Claim	8-Apr-13	8-Apr-22	N/A	25.0
1045410	Mineral Claim	18-Jul-16	18-Jul-22	N/A	34.6
					22,289.1

Note: Numbers have been rounded. Totals may not sum due to rounding.

Table 4-2: Red Chris South Block Claims

Title Number	Title Type	Issue Date	Good To Date	Expiry	Area (ha)
667223	Mineral Claim	10-Nov-09	11-Nov-27	N/A	435.6
667243	Mineral Claim	10-Nov-09	11-Nov-27	N/A	435.6
667244	Mineral Claim	10-Nov-09	11-Nov-27	N/A	435.6
667263	Mineral Claim	10-Nov-09	11-Nov-27	N/A	435.6
667303	Mineral Claim	10-Nov-09	11-Nov-27	N/A	435.6
667306	Mineral Claim	10-Nov-09	11-Nov-27	N/A	418.0
667307	Mineral Claim	10-Nov-09	11-Nov-27	N/A	400.5
667308	Mineral Claim	10-Nov-09	11-Nov-27	N/A	435.4
667803	Mineral Claim	10-Nov-09	11-Nov-27	N/A	348.2
667804	Mineral Claim	10-Nov-09	11-Nov-27	N/A	34.6
667824	Mineral Claim	11-Nov-09	11-Nov-27	N/A	17.3
668024	Mineral Claim	11-Nov-09	11-Nov-27	N/A	814.5
668043	Mineral Claim	11-Nov-09	11-Nov-27	N/A	831.8
668044	Mineral Claim	11-Nov-09	11-Nov-27	N/A	34.7
668045	Mineral Claim	11-Nov-09	11-Nov-27	N/A	25.0

Title Number	Title Type	Issue Date	Good To Date	Expiry	Area (ha)
668063	Mineral Claim	11-Nov-09	11-Nov-27	N/A	200.0
668064	Mineral Claim	11-Nov-09	11-Nov-27	N/A	450.0
824662	Mineral Claim	22-Jul-10	11-Nov-27	N/A	433.1
824682	Mineral Claim	22-Jul-10	11-Nov-27	N/A	311.7
824722	Mineral Claim	22-Jul-10	11-Nov-27	N/A	52.0
824742	Mineral Claim	22-Jul-10	11-Nov-27	N/A	17.3
824762	Mineral Claim	22-Jul-10	11-Nov-27	N/A	51.9
824782	Mineral Claim	22-Jul-10	11-Nov-27	N/A	17.3
824802	Mineral Claim	22-Jul-10	11-Nov-27	N/A	34.6
824822	Mineral Claim	22-Jul-10	11-Nov-27	N/A	34.7
824842	Mineral Claim	22-Jul-10	11-Nov-27	N/A	34.7
838224	Mineral Claim	12-Nov-10	12-Mar-27	N/A	17.3
					7,192.6

Note: Numbers have been rounded. Totals may not sum due to rounding.

Figure 4-2: Mining Leases and Current Mine Layout

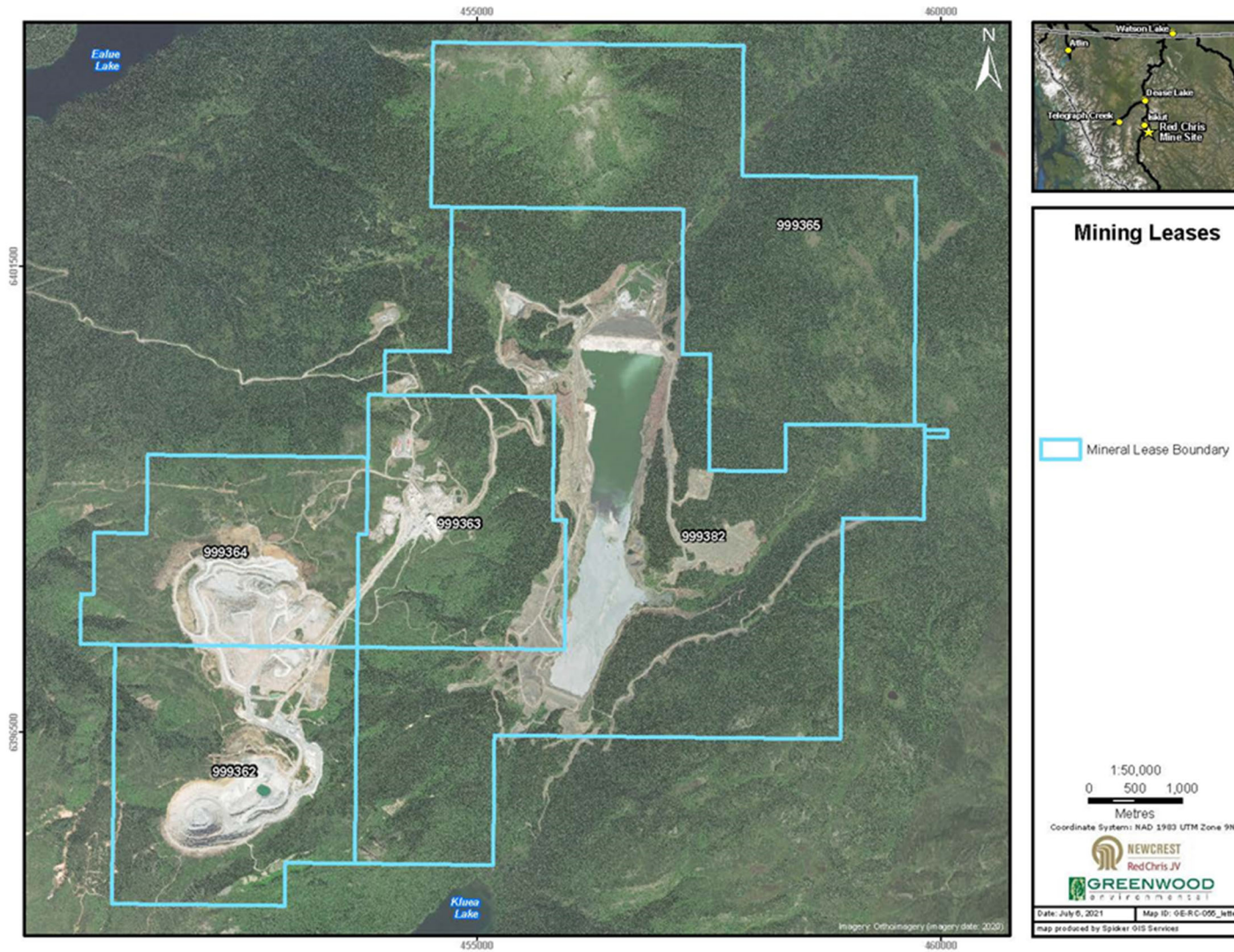
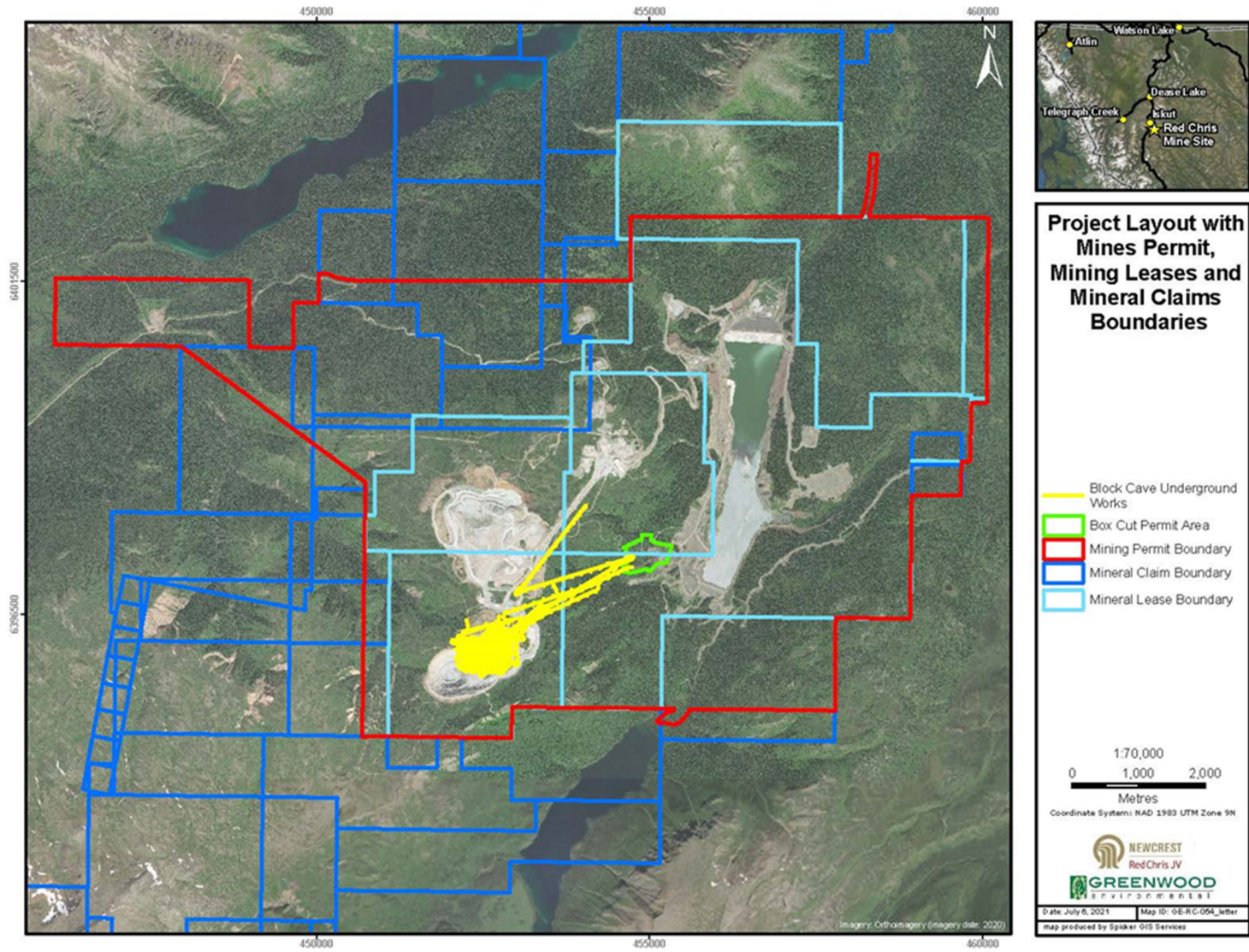

Figure 4-3: 2021 PFS Layout In Relation To Mining Leases



4.6 Water Rights

Applications for groundwater licences under the Water Sustainability Act were submitted and are under review by the FLNRORD for new and existing groundwater use for 'Mining Use' (TIA production wells) and for groundwater existing use for 'Industrial Purpose' (camp wells). Under the *Water Sustainability Act*, a new licence application is required to increase (or reduce) the quantity of water authorized to be diverted (an amendment of an existing water licence to increase or reduce the authorized quantity is only available where the quantity was erroneously estimated). If Newcrest must divert a greater quantity of groundwater in connection with further phases of the Project, a new *Water Sustainability Act* license may be required.

4.7 Royalties and Encumbrances

The five mining leases and 31 of the mineral claims are subject to a net smelter return royalty held by the Tahltan Central Government, and subject to the confidentiality terms of the Impact, Benefit and Co-Management Agreement (IBCA). Annual advance royalty payments commenced in October 2016.

All or portions of four of the mining leases and 19 mineral claims are also subject to a 1.0% net smelter return royalty held by International Royalty Corporation, a subsidiary of Royal Gold Inc. (Royal Gold).

The Red Chris South claim group is subject to a 1.5% net smelter return royalty held by Canada Carbon Inc. The royalty may be reduced to 0.5% by payment from Newcrest to Canada Carbon Inc. of \$1 million.

4.8 Property Agreements

An IBCA between the Tahltan Central Government, the Iskut First Nation, the Tahltan Band and the Red Chris Operations is in place. The IBCA was restated and amended on 15 August 2019 upon Newcrest's acquisition interest.

The IBCA provides the basis for a life-of-mine partnership covering royalties, education, training, employment, contracting opportunities, capacity support, provisions for communication, and interaction on social and environmental matters.

4.9 Permitting Considerations

Permitting considerations are discussed in Section 20.

4.10 Environmental Considerations

Environmental considerations are discussed in Section 20.

Current environmental liabilities are in line with those to be expected from a long-life mining operation where mining activities are conducted via open pit mining methods. These include the open pit, operations infrastructure, and access roads.

4.11 Social License Considerations

Social license considerations are discussed in Section 20.

4.12 QP Comments on “Item 4; Property Description and Location”

In the opinion of the QP:

- Information provided by Newcrest’s legal and tenure experts on the mining tenure held by Newcrest in the Project area supports that the Red Chris Joint Venture has valid title that is sufficient to support declaration of Mineral Resources and Mineral Reserves;
- Newcrest holds sufficient surface rights to allow open pit mining activities at Red Chris;
- Additional negotiations and permits are required for the proposed block cave operations (see discussion in Section 20);
- Newcrest holds permits that allow abstraction of groundwater and surface water for current operational needs;
- Environmental liabilities for the Project are typical of those that would be expected to be associated with a long-lived open pit mining operation.

To the extent known to the QP, there are no other significant factors and risks that may affect access, title, or the right or ability to perform work on the Project that are not discussed in this Report.

5 ACCESSIBILITY, CLIMATE, LOCAL RESOURCES, INFRASTRUCTURE, AND PHYSIOGRAPHY

5.1 Accessibility

Road access to the Project area from Highway 37 is via an 18 km-long gravel road.

Most of the Project is accessible only by foot or by helicopter.

The nearest airports with regular commercial flights are in Terrace and Smithers, each approximately 500 km to the south. There are irregularly maintained airstrips in Iskut, and approximately 100 km to the south at Bob Quinn Lake.

The Dease Lake airport, approximately 80 km to the north via BC Highway 37, is the transit point for the fly-in/fly-out operations. Chartered aircraft fly employees to the Dease Lake airstrip from where they are transported by bus to the mine site.

Stewart is the nearest port with ship-loading facilities, a distance of 320 km by road from the Red Chris Operations.

5.2 Climate

The climate in the Project area is northern temperate with moderately warm summers and cold dry winters. Typical daytime temperatures range from 20°C in the summer to -20°C or lower in the winter. The Project area receives an average of 530 mm total annual precipitation which is more or less evenly distributed throughout the year, with April–May typically receiving the least rainfall and August–December the most.

Mining operations are conducted on a year-round basis. Exploration activities can be temporarily curtailed by winter conditions.

5.3 Local Resources and Infrastructure

A range of infrastructure and associated facilities are available in Terrace and Smithers. Dease Lake is the service and government centre for residents of the region.

The nearest significant settlement to the Project is the village of Iskut.

Project infrastructure is discussed in more detail in Section 18.

5.4 Physiography

The Project is situated on the eastern portion of the Todagin upland plateau that forms a subdivision of the Klastine plateau along the northern margin of the Skeena Mountains. Elevations on the plateau are typically 1,500 ± 30 m, with relatively flat topography broken by several deep creek gullies.

The majority of the Project area is covered by several metres of glacial till. Bedrock exposure is confined to the higher-relief drainages and along mountainous ridges.

The south TIA, open pit and waste rock storage facilities (WRSFs) are within the Iskut River watershed, with downstream tributaries flowing into Trail Creek, and Kluea and Todagin Lakes. Thurston's Trickle and two unnamed creeks are ephemeral water courses that report to the TIA. Camp Creek drains waters south of the open pit into Trail Creek.

Vegetation consists of spruce and balsam forest cover with stands of aspens and scrub conifers at the lower elevations while buckbrush, willow and slide alder are common along the steep-sided, incised creek valleys. At higher elevations dwarf birch, willow and balsam dominate. Above the tree line at about the 1,370 m elevation contour, alpine grasses and flowers are the predominant vegetation.

5.5 Tahltan Nation

The Red Chris Operations are located within the territory of the Tahltan Nation, which covers approximately 95,933 km² and goes from the mouth of the Iskut River in the south to the Rancheria River in the Yukon, from the eastern slopes of the Coastal Mountains in the west to the headwaters of the Stikine and the upper half of the Turnagain River in the east. Tahltan territory also extends into the Yukon.

The Tahltan collectively hold rights to hunt, fish, trap and harvest berries and other food and medicinal plants throughout their asserted traditional territory. Tahltan members of local communities traditionally hunt moose, caribou, sheep, goat and groundhog in the Project vicinity.

Tahltan Nation peoples have a long history of cooperation with the mining and exploration sectors, and are an important source of both skilled and semi-skilled labour regionally. The Tahltan Nation Development Corporation is a local and regional employer, and has participated in the mining, road construction, hydroelectric power generation, forestry, catering, custodial work, heavy construction, road development and transportation sectors.

5.6 Land Usage

The mine area falls within the area covered in the Cassiar Iskut Stikine Land and Resource Management Plan. Exploration and development for minerals and energy, including development of road access, are acceptable activities throughout the plan area outside of protected areas, subject to regulations of statutes. The Red Chris Operations also overlap the Todagin Zone which includes Todagin Plateau and Tsatia Mountain, and the eastern boundary extends to the treeline of the Klappan drainage. The management intent for the Todagin Zone is to integrate management for Stone's sheep and other wildlife, recreational activities, and mineral exploration, mine development, and reclamation.

Land Act tenures in the area around the operations include a recreation reserve around Ealue Lake, and another near the Tatogga Lake Resort; a railway right-of-way designated use area running north–south about 13 km east of the mine; and the tenure for Highway 37 running north–south about 12 km east of the operations. There is an

interim licence for a power line right-of-way running northeast from Tatogga Lake to a point about 8 km from the mine, and a small sand and gravel tenure on the east side of Eddontenajon Lake about 14 km northwest of the mine.

Other land uses in the area include hunting and trapping. The operations are in Region 6 (Skeena Region) within Management Unit 6-20, and lie within trapline TR620T001, which covers 2,324,370 ha, registered to members of the Iskut Band. The Project is in the guiding territory registered to Jerry Creyke (Guiding Certificate 601025), which stretches from the Klappan River to Mount Edziza. Kinaskan Lake Outfitters, operated by the Creyke family, generally guides in the area from August to October, concentrating hunts for stone sheep, mountain goat, moose, black bear, and wolf in the Todagin Mountain area (Kinaskan Lake Outfitters, 2019).

The operations are located within the Cassiar Timber Supply Area, which covers 13,131,876 ha; of this, 210,681 ha (or 1.6%) are available for timber harvesting (Government of British Columbia, 2013). Forestry activity within the Cassiar Iskut–Stikine Land and Resource Management Plan area is limited because of extensive alpine and sub-alpine areas with very low timber volumes, with only localized concentrations of stands suitable for timber harvesting.

5.7 QP Comments on “Item 5; Accessibility, Climate, Local Resources, Infrastructure, And Physiography”

In the opinion of the QP, the existing local infrastructure, availability of staff, methods whereby goods could be transported to the Project area are well-established and well understood by Newcrest, and can support the declaration of Mineral Resources and Mineral Reserves.

Surface rights are outlined in Section 4.5.

Operations are conducted year-round.

6 HISTORY

6.1 Exploration History

The Project exploration and development history is summarized in Table 6-1.

6.2 Production History

Production from the commencement of mining in 2015 is provided in Table 6-2. Newcrest obtained a 70% Project ownership interest in 2019, and was entitled to 70% of the production from that date forward.

Table 6-1: Exploration and Development History

Year	Operator	Work Conducted
1956	Conwest Exploration Ltd.	Examined copper showings on the Todagin plateau, later pegged as Windy claims. Completed a pack-sack X-ray drilling program.
1969–1972	Great Plains Development Company of Canada Ltd. (Great Plains)	Staked the Chris and Money claims. Collected approximately 534 B-horizon soil, and 8 rock samples. Reconnaissance geological mapping. Completed 10 core holes (1,231 m); undertook trenching program; 12 km induced polarization (IP) ground geophysical survey. Drill holes intersected weak pervasive (hypogene) alteration controlled by fracturing with low supergene copper mineralization near surface.
1971	Silver Standard Mines Ltd. (Silver Standard)	Staked the Red and Sus claims. Collected B-horizon geochemical samples. Bulldozer trenching (457 m). Two trenches exposed low-grade copper mineralization in intrusive rocks.
1973	Ecstall Mining Limited (Ecstall)	Optioned the Silver Standard claims and drilled 14 percussion holes, intersecting low-grade copper mineralization.
1974–1980	Texasgulf Canada Ltd. (Texasgulf)	Ecstall became Texasgulf. Acquired an option on 60% of the combined Red and Chris groups of claims. Undertook an overburden geochemical sampling program, IP surveys, and a 6 km proton magnetometer survey. Completed 74 core holes (13,301 m); 44 percussion drill holes (3,173 m); trenching (558 m). Delineated the Red stock and the Main and East zones of quartz stockwork-hosted mineralization. Initial resource estimate.
1991–1993	Dryden Resource Corp. (Dryden)	490 B-horizon soil, 116 silt and 44 rock chip samples taken; minor hand trenching
1994	Falconbridge; Norcen Energy; Teck Corporation	A series of corporate takeovers and reorganizations resulted in the ownership of the property divided amongst Falconbridge (60%), Norcen Energy (20%), and Teck Corporation (20%). American Bullion Minerals Ltd. (American Bullion) acquired an 80% interest in early 1994, with Teck Corporation retaining a 20% interest.
1994–1996	American Bullion	Mineral claim staking, land surveying, line cutting, soil geochemistry (547 B-horizon), geophysics including 74 km ground magnetic, 26 km very low frequency electromagnetic (EM), and 72 km IP surveys; camp and core logging facility construction; 170 core holes (58,187 m), mineral resource estimation; 3 (59 m) geotechnical holes; acid base accounting studies; base-line environmental studies; petrographic and metallurgical studies. Discovered near surface copper–gold mineralization at the Gully and Far West zones.
2004–2006	bcMetals Corporation (bcMetals)	Acquired interest in Red Chris area. Completed 4.6 km seismic and 6.5 km EM survey; 88 core holes (28,197 m), 24 geotechnical test pits, mineral resource and mineral reserve estimation, feasibility study. Due diligence investigation as a result of planned joint venture agreement between bcMetals and the Global International Jiangxi Copper Company Ltd.

Year	Operator	Work Conducted
2006–2018	Imperial	<p>Launched a take-over bid for bcMetals in 2006, acquiring the company in 2007. Geological mapping; rockchip, mass mass and inductively-coupled plasma (ICP) composite geochemical samples; Proton magnetometer surveys; 30 km Titan -24 direct current induced polarization (DCIP) and magnetotellurics (MT) ground geophysical surveys; 1,295 km Aeroquest airborne magnetic geophysical survey; proton precession ground magnetometer geophysical surveys; borehole acoustic televiewer surveys; Mineral Resource and Mineral Reserve estimation; geotechnical, water bore and condemnation drilling in support of mine development; environmental studies and surveys in support of project permitting. Conducted preliminary engineering studies on a potential underground operation.</p> <p>Mine construction commenced May 2012, and was completed May 2014. The first full year of mine production was 2016.</p>
2011	Bolero Resources Corp.	<p>Completed 818 soil samples, 15 rock chips samples and four drill holes totalling 1,450 m in the Red Chris South claims area. No evidence from drilling, rock and soil sampling, or prospecting gave direct indications of Red Chris-style copper–gold porphyry mineralization; however, drilling did not test beneath the Bowser Group cover sequence</p>
2019–2021	Newcrest	<p>Acquired 70% interest in the Red Chris operation. Newcrest Red Chris Joint Venture formed, with Newcrest as operator. Commenced mine and process plant optimisation. Completed resource definition, geotechnical and hydrogeological drilling at the East zone; updated Mineral Resource and Mineral Reserve estimates; completion of a pre-feasibility study on a block cave operation. Exploration activities included an airborne geophysical survey (Z-Axis Tipper Electromagnetics (ZTEM), gravity, magnetics), brownfield exploration drilling at East Zone, Main Zone, Gully Zone, Far West and the discovery of a new zone of mineralisation at East Ridge. A total of 128 B and C horizon soil samples collected at East Ridge.</p>

Table 6-2: Production History

Year	Tonnes Processed (t)	Contained Copper (lb)	Contained Gold (oz)	Contained Silver (oz)
2015 *	8,171,879	58,485,922	25,949	95,232
2016	9,651,738	83,614,330	47,088	190,624
2017	10,378,181	74,636,087	33,416	133,157
2018	10,668,313	63,349,009	41,935	103,634
2019	10,430,762	71,880,182	36,471	133,879
2020	9,381,454	88,343,653	73,787	176,375
2021 #	7,199,574	50,704,124	46,549	129,544
Total	65,881,901	491,013,307	305,195	962,445

Note: * = partial year from 17 February to 31 December. # = partial year to Q3, 2021.

7 GEOLOGICAL SETTING AND MINERALIZATION

7.1 Regional Geology

The regional geological setting comprises island arc volcanic, sedimentary, and plutonic rocks of the Middle to Late Triassic Stuhini Group, the Early to Middle Jurassic Hazelton Group, and the Middle and Upper Jurassic to Lower Cretaceous Bowser Lake Group, which form the accreted geological terrane of Stikinia in the northern Intermontane Belt of the Canadian Cordillera.

Several large calc-alkalic Late Triassic plutons (Stikine suite, ca 222–216 Ma (Zhu et al., 2018)) cut the Stuhini Group, and are interpreted to mark an approximate Late Triassic arc axis formed as a result of southward subduction.

The Stikine terrane hosts a number of porphyry, epithermal, and volcanic massive sulphide deposits, including the Red Chris deposit (Figure 7-1).

7.2 Project Geology

7.2.1 Lithologies

A Project geology plan is provided in Figure 7-2.

The basement rocks in the Project area are Late Paleozoic metavolcanic and metasedimentary rocks of the Stuhini Group, which have been intruded by granodiorite/diorite bodies.

Overlying the Stuhini Group are feldspathic sandstones, siltstone, basaltic–andesitic volcanic and volcanoclastic rocks of the Late Triassic Stuhini Group that are intruded by a series of diorite to quartz monzonite dikes (Red Stock). A deformation event, interpreted to be Late Triassic in age, pre-dated intrusion of the Red Stock and is evidenced by the intrusions being relatively upright and less deformed than their Stuhini Group host rocks.

Overlying these units are siltstones, sandstones and limestones of the Early to Middle Jurassic Hazelton Group that have been intruded by alkali granite bodies. Uplift and erosion that occurred in the Early Jurassic resulted in these rocks being unconformably deposited on the Stuhini Group and Red Stock lithologies.

The Bowser Lake Group, Middle Jurassic in age, consists of sandstone, siltstone and conglomerates, and paraconformably overlies the Hazelton Group. Intrusive into these sediments are leucogranite and quartz monzonite bodies.

The topmost lithology consists of olivine basalts of the Mio–Pliocene Maitland Volcanics. Glacial and post-glacial sediments overlie all units.

Figure 7-1: Regional Geological Map

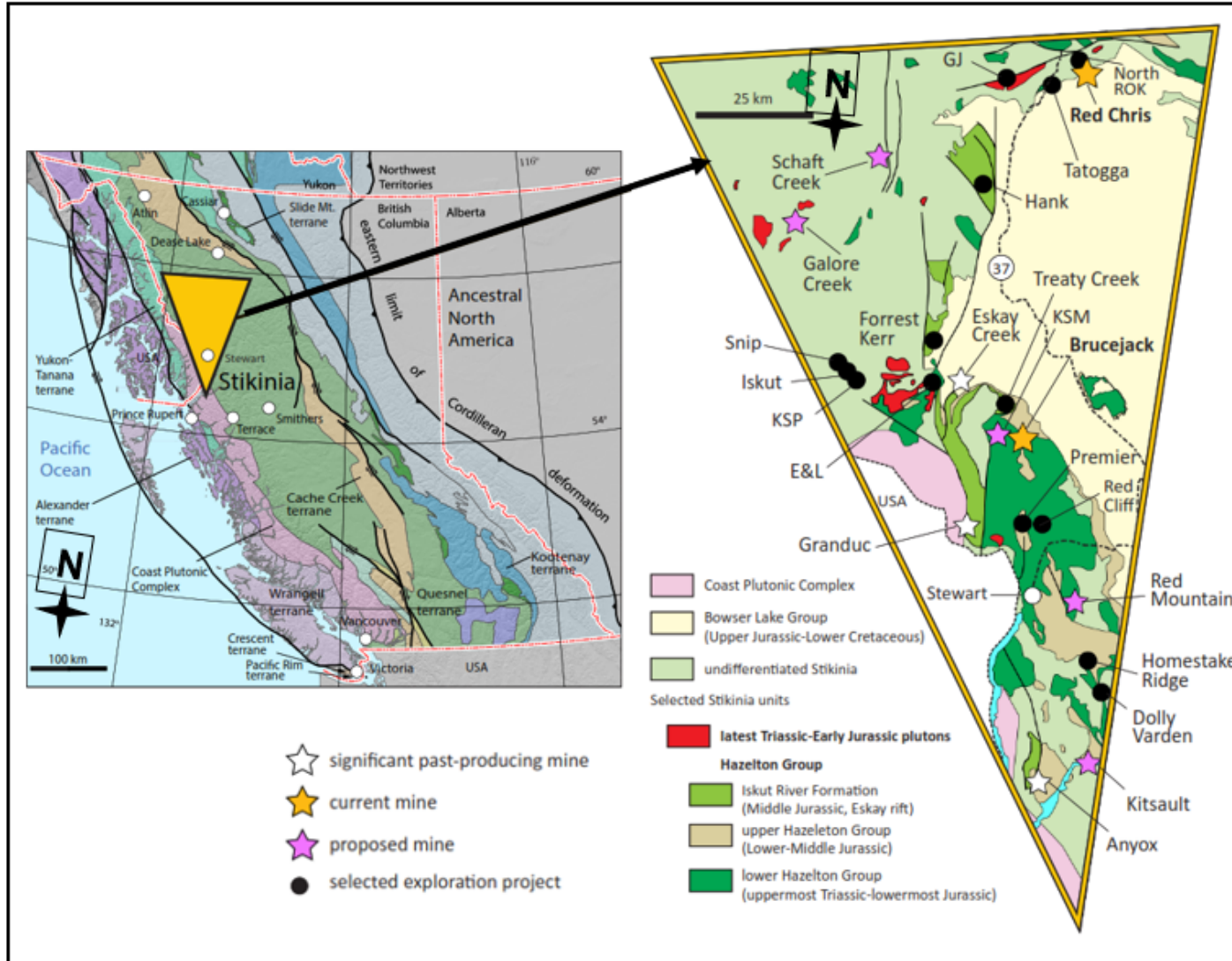

Note: Figure from British Columbia Geological Survey, 2018.

Figure 7-2: Project Geology Map

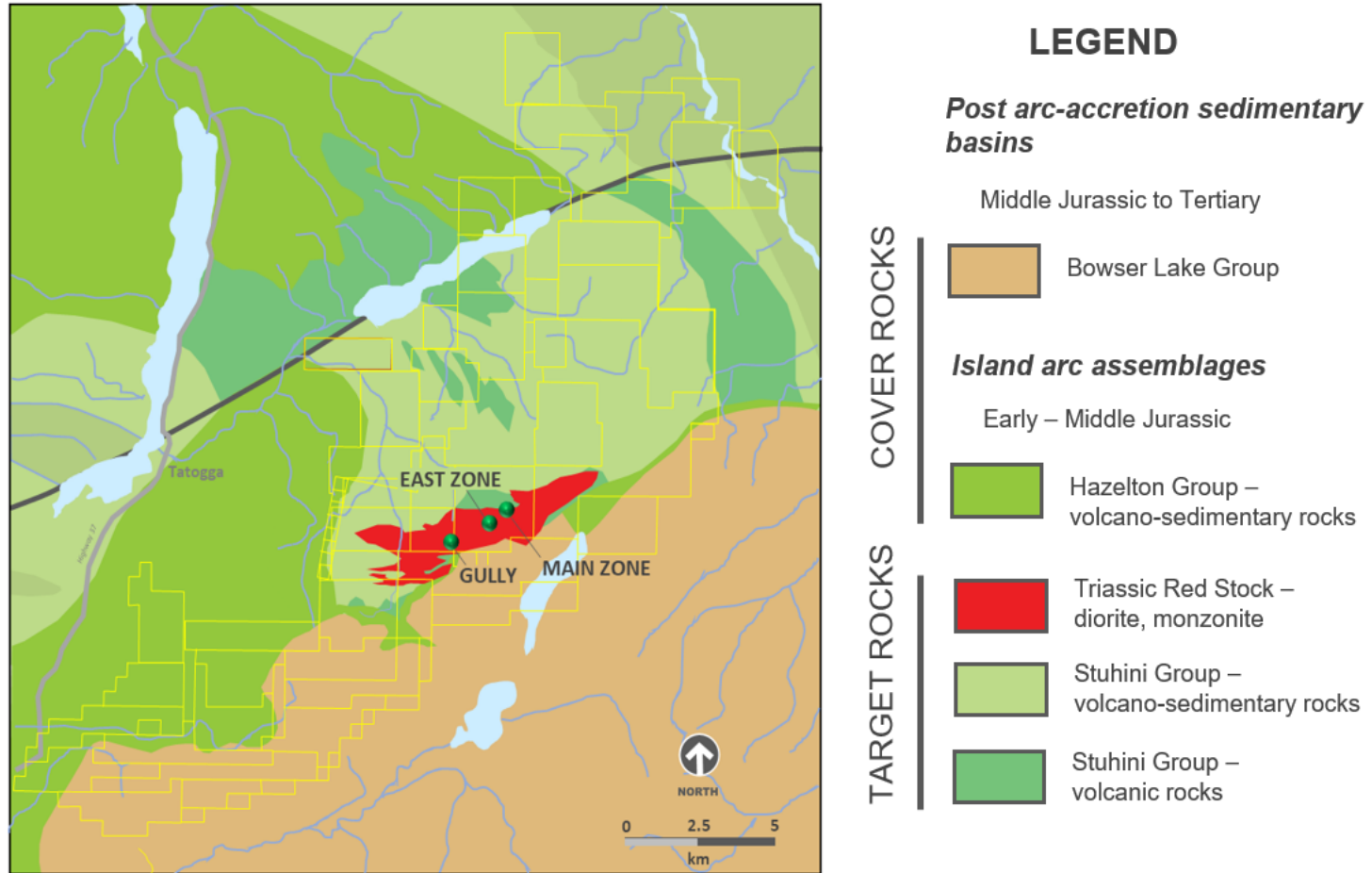

Note: Figure prepared by Newcrest, 2021.

7.2.2 Metamorphism

Metamorphic grade in the Stuhini Group is very low (sub-greenschist) although there is local hornfelsing around intrusions. The Stikine Assemblage displays greenschist facies metamorphism.

7.2.3 Structure

Significant faults in the region have a dominant northeast trend. A series of faults with demonstrated southeast side-down relative displacements have been mapped in the Red Chris area, locally truncating the northwestern limit of the Hazelton and Bowser Lake units.

7.2.4 Weathering

Typically, the effects of weathering are limited due to the recent retreat of glaciers that formerly covered the area.

Prominent limonitic gossans and natural kill zones occur within the steep slopes and drainages over the Gully and Far West zones. However, in areas without drainage relief such as over the East and Main zones, weak limonite extends only 1–2 m beneath the top of the bedrock. The overlying gravel till layer is often very limonitic or composed of ferricrete.

Supergene chalcocite mineralization was intersected in shallow drilling near the headwaters of the East Gully drainage. Chalcocite occurs along with malachite, azurite and manganese oxides in this oxidized zone.

7.3 Local and Deposit Geology

7.3.1 Lithologies

The Late Triassic Red Stock hosts the Red Chris deposit. The Red Stock is about 8 km long by 1.5 km wide at surface, and elongate in the east–northeast direction series of multiphase porphyritic diorite to quartz monzonite stocks and dikes. It is interpreted to have been tilted to about 15° to the south–southeast. It has three main phases (Table 7-1).

Two subunits of the Stuhini Group are recognized. The lower subunit is dominated by mudstone, siltstone, and sandstone, with minor lenses of volcanic rocks. Within approximately 500 m of the stock contact, the mudstones form competent, massive to laminated hornfels. The upper subunit consists predominantly of volcanic flows, flow breccias, and epiclastic rocks of basaltic to andesitic composition.

A cross-section through the East zone showing the lithologies is provided as Figure 7-3.

Table 7-1: Red Stock Phases

Phase	Description
P1	Fine to medium, crowded hornblende-plagioclase phyric monzodiorite (pre-mineral)
P2	Medium, crowded plagioclase phyric monzonite (mineralising)
P3	Coarse, crowded hornblende phyric monzonite (post-mineral)

Figure 7-3: Red Chris Lithological Model, East Zone (Section 27N)

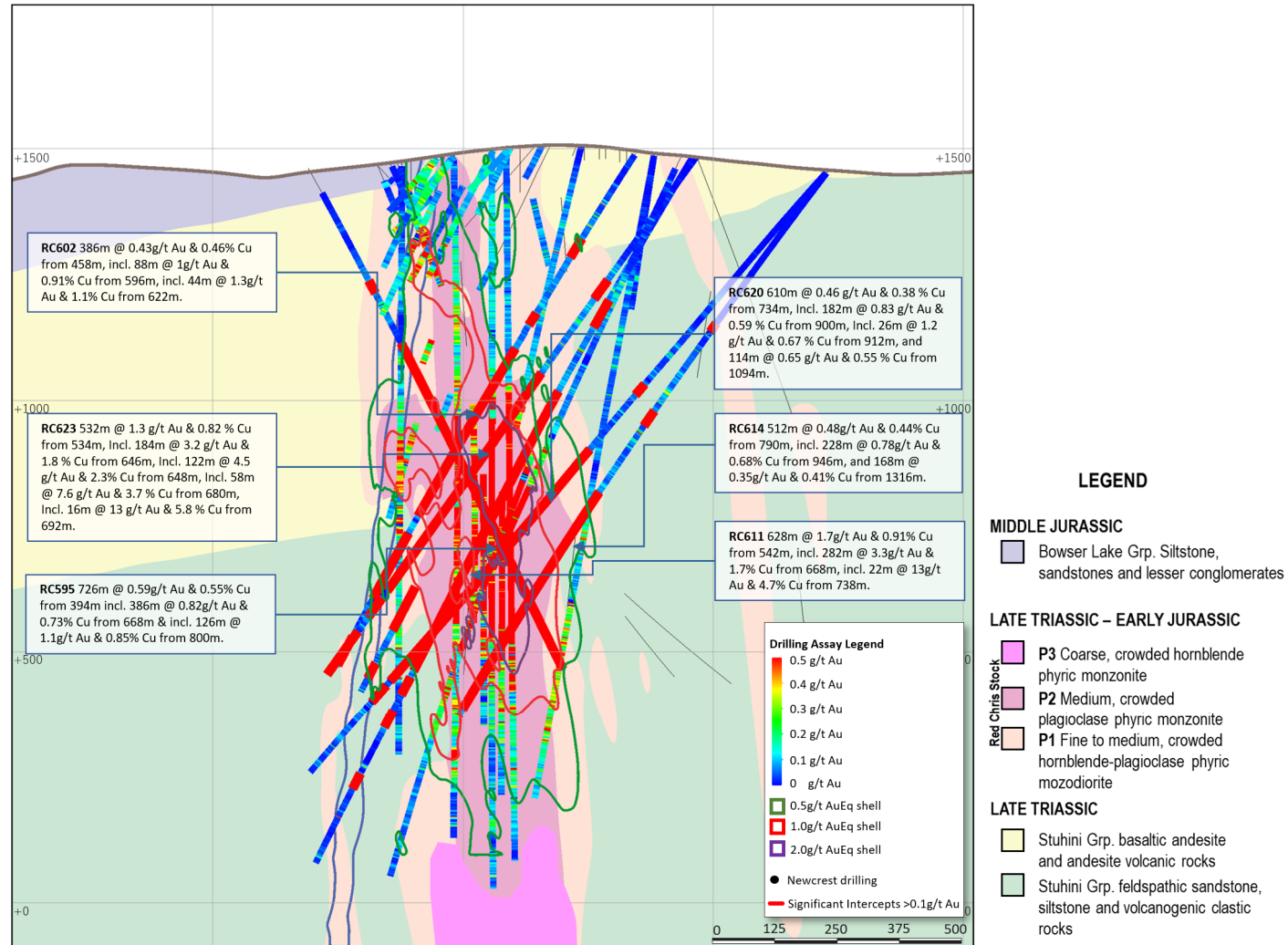

Note: Figure prepared by Newcrest, 2021. Section looks southwest.

7.3.2 Oxidation

Supergene oxidation of the system is mostly of negligible thickness. In the low relief areas overlying the Main and East zones, weak limonite extends only 1–2 m below the top of bedrock. It appears that glaciation removed any significant supergene copper mineralisation that might have existed over the Red Chris deposit. Fracture-controlled and weak selective oxidation locally occurs to depths >100 m, especially in close proximity to structures.

7.3.3 Structure

Significant faults in the region have a dominant northeast trend. A series of faults with demonstrated southeast side-down relative displacements has been mapped in the Red Chris area, locally truncating the northwestern limit of the Hazelton and Bowser Lake units.

Several significant faults cut the Red Stock, influence patterns of mineralisation and alteration, and involve late mineral and/or post-mineral displacement.

The earliest fault generation is a series of west–northwest-striking, moderately to steeply northward-dipping, DZ faults. The DZ faults are localized in the hydrolytically-altered rocks generally along the margins of the different porphyry phases. In drill holes the faults are variable related to alteration and mylonitic to cataclastic fault rock fabrics. The DZ faults offset the different porphyry phases and associated mineralisation suggesting northside down and dextral strike-slip with offsets of <50 m.

The South Boundary fault is an important post-mineral fault cutting the Red Stock. At the surface, it forms part of the southern margin of the stock and limits mineralisation in the East zone area. It appears to have up to 500 m of sinistral displacement of the mineralization, based on mapping at surface, reconstruction of East Zone, and the location of the recently-discovered East Ridge deposit.

The sub-parallel EZ fault, at surface, is a sub vertical splay of the South Boundary Fault, limiting the extent of mineralisation near surface.

7.3.4 Alteration

Potassic alteration is best preserved below the 1,200-m elevation in the East zone, and at somewhat deeper levels in the Main zone. The original upper and outer limits of potassic alteration are difficult to define due to strong overprinting by later sericite-clay-carbonate assemblages. Potassic and intermediate argillic alteration appear to be directly related to the mineralization.

A laterally-extensive phyllic alteration halo extends laterally >500 m from the high-grade core. It is typically characterised by quartz-sericite-pyrite alteration as vein halos and as pervasive alteration of the groundmass of Red Stock intrusive phases.

An outer propylitic (chlorite–epidote–albite–carbonate–hematite) halo primarily affects the Stuhini Group volcanic and sedimentary rocks on the north side of the deposit. It

truncates mineralization in the core of the deposit as late post-mineral stage monzonite intrusions and/or mafic dykes.

Late calc-potassic (K-feldspar–albite–biotite–chlorite–epidote–magnetite ± actinolite) alteration associated with late and post-mineral intrusions cuts all of the other alteration phases.

Deep sodic (albite–quartz–actinolite–illite–carbonate) alteration affects the Stuhini Group sediments and late-mineral monzonite.

Post-mineral mafic dykes cut all other lithologies and are variably altered to clay, propylitic alteration or minor carbonate. Bowser Lake Group sediments are relatively unaltered.

An example cross-section showing the alteration types is included as Figure 7-4.

7.3.5 Mineralization

The Red Chris deposit is about 3.4 km in strike length, 0.3 km in width and over 1.3 km in vertical extent. There are two main zones, East and Main. The Main zone is 1,200 m in strike length, 300 m in width and has been drill tested to 1,300 m depth. The East zone is 1,200 m in strike length, 300 m in width and has been drill tested to 1,400 m depth.

Figure 7-5 is a cross-section through the mineralization in the East zone, showing quartz vein percentages. Figure 7-6 is a cross-section through the mineralization in the East zone showing sulphide mineral types.

The zone of >0.2% Cu%, is >3 km long, oriented west–southwest–east–northeast and can reach 650 m in width. Quartz–magnetite stockworks are overprinted by higher gold and copper grades. The highest copper–gold grades occur in and around the P2 porphyries and associated igneous breccias.

Mineralisation consists of thin wavy or thicker planar quartz veins containing chalcopyrite, bornite and magnetite; these minerals are also disseminated outside the veins. In the upper part of the deposit, the bornite-rich mineralisation was overprinted by sericite and clay alteration and associated sulphidation. Gold occurs as microscopic inclusions in the copper sulphides, and occasionally as free grains in high-grade zones.

Molybdenite occurs locally in quartz veins, especially deeper and outside the high-grade core.

Figure 7-4: Red Chris Alteration Model, East Zone (Section 27N)

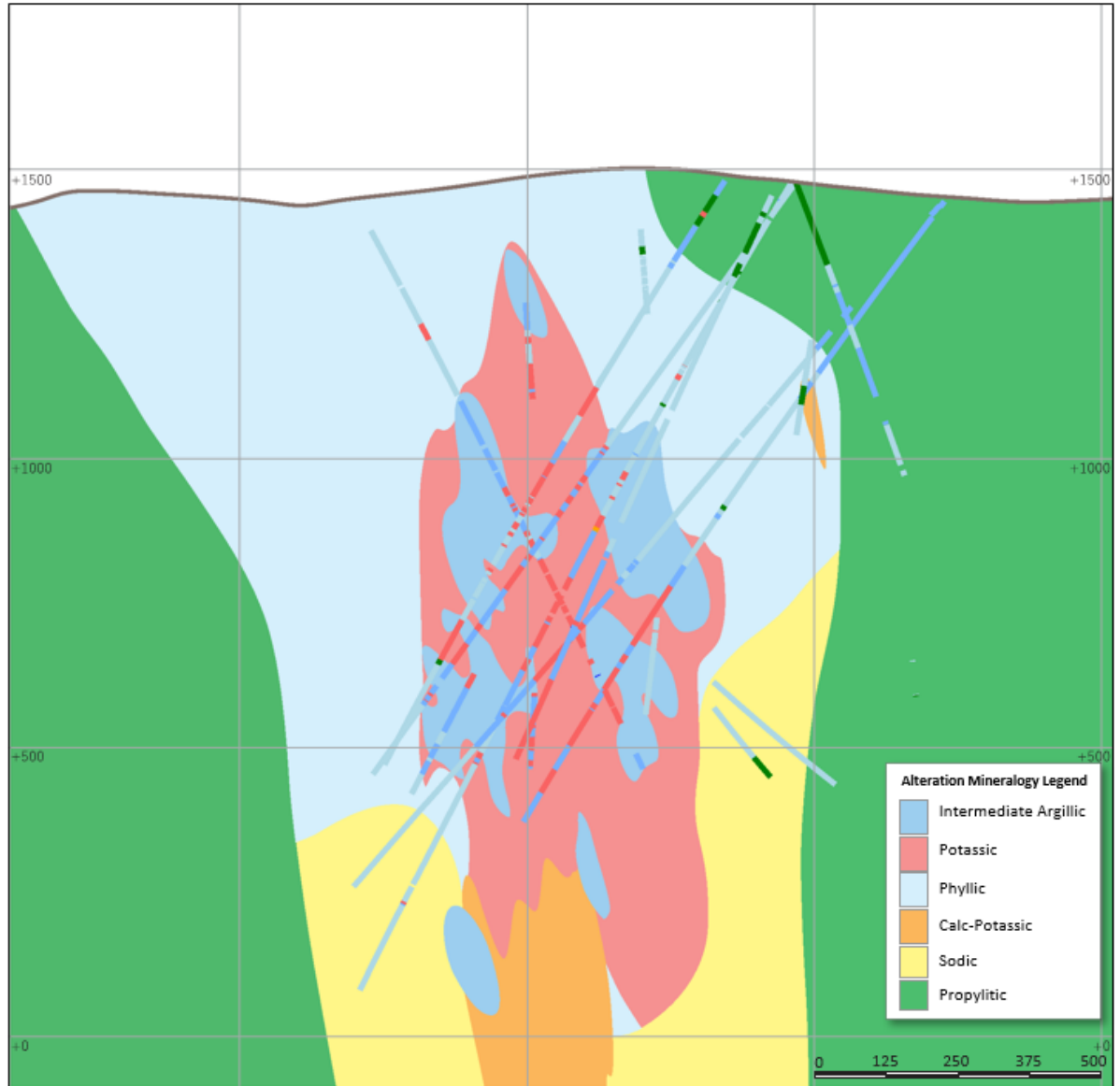

Note: Figure prepared by Newcrest, 2021. Section looks southwest.

Figure 7-5: Red Chris Quartz Vein Volume Model, East Zone (Section 27N)

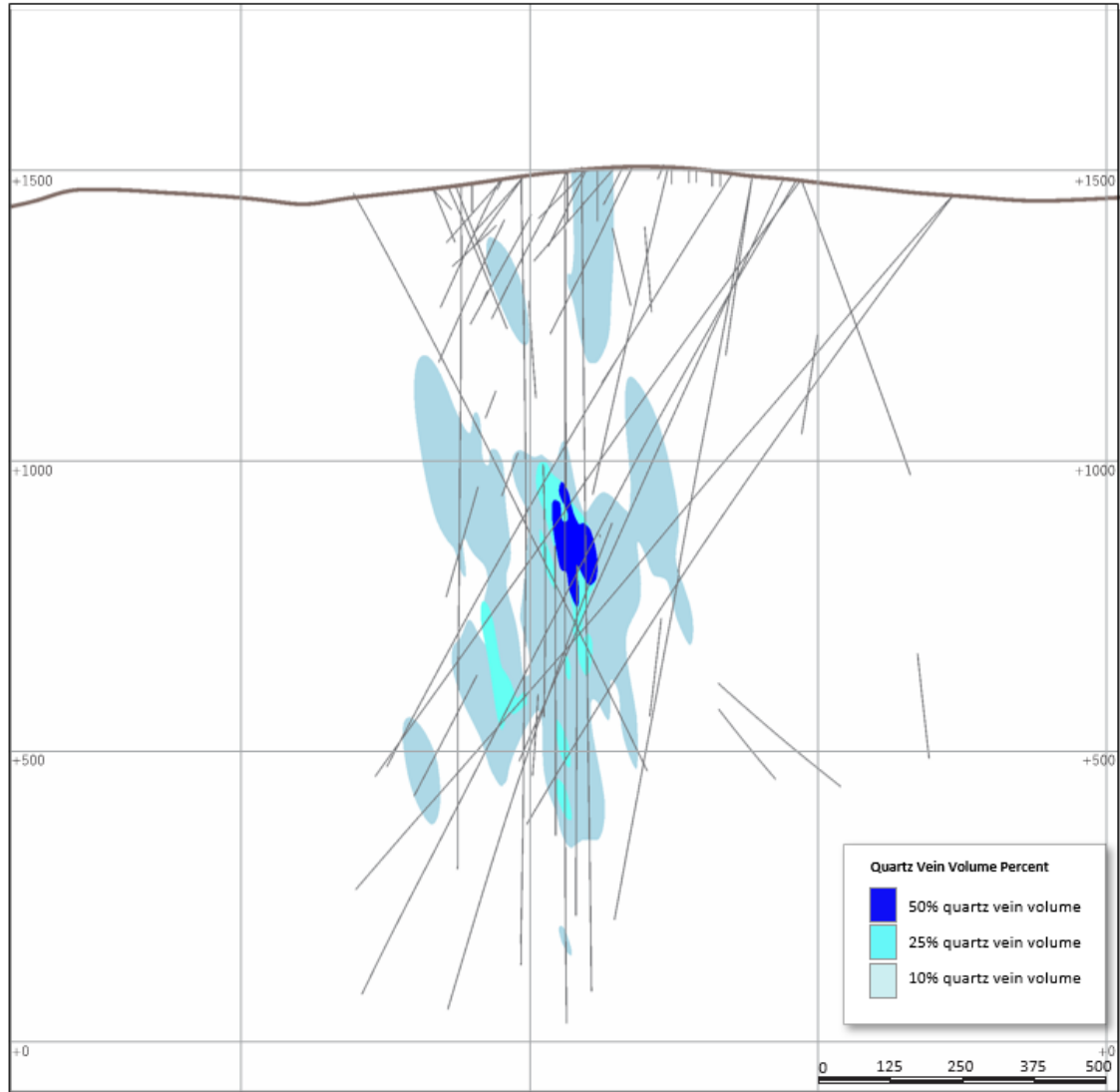

Note: Figure prepared by Newcrest, 2021. Section looks southwest.

Figure 7-6: Red Chris Sulphide Speciation Model East Zone (Section 27N)

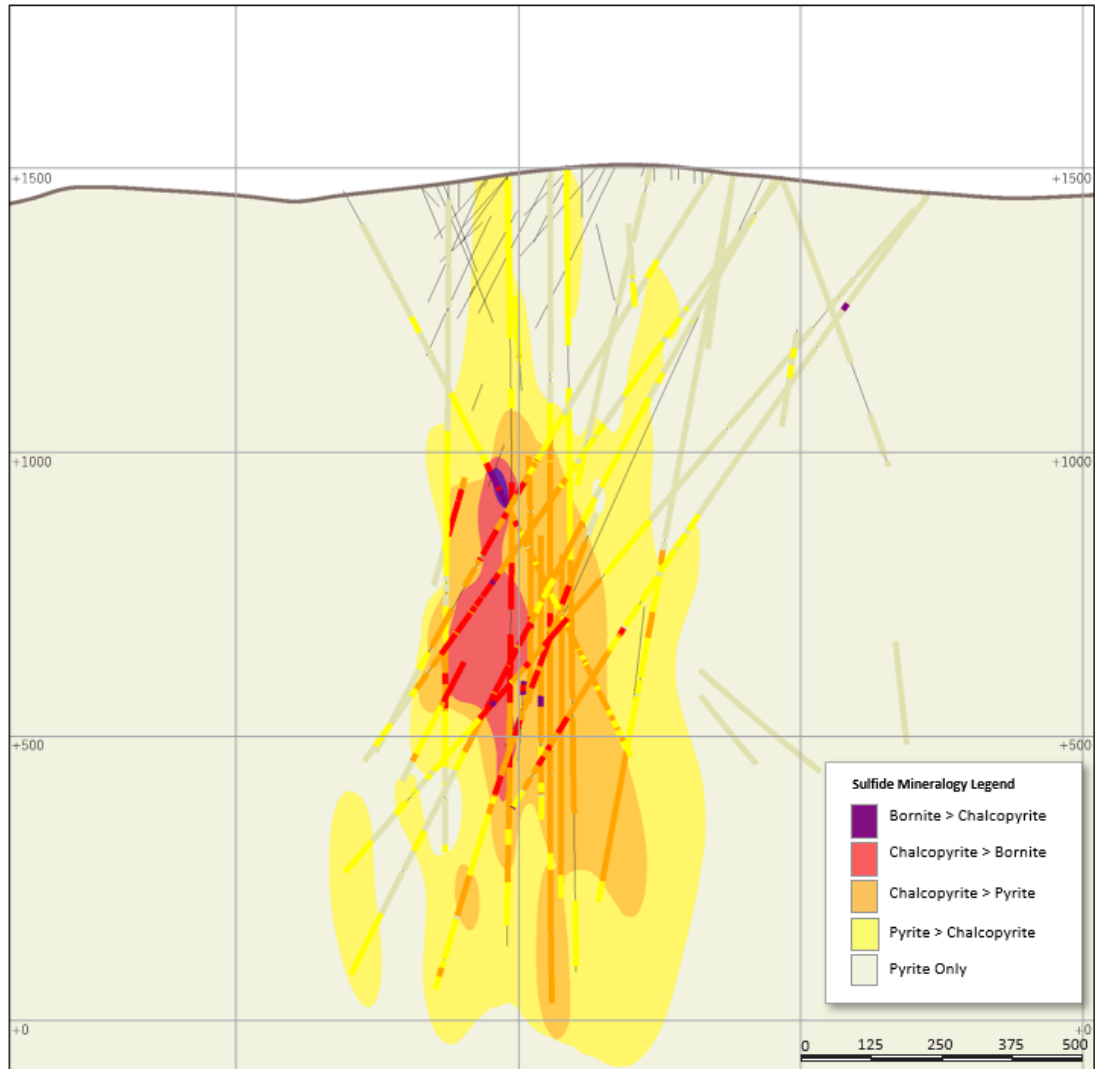

Note: Figure prepared by Newcrest, 2021. Figure looks southwest.

7.4 Prospects/Exploration Targets

Exploration potential is discussed in Section 9.

7.5 QP Comments on “Item 7: Geological Setting and Mineralization”

In the opinion of the QP:

- The understanding of the Red Chris deposit setting, lithologies, and geological, structural, and alteration controls on mineralization is sufficient to support estimation of Mineral Resources and Mineral Reserves;
- The geological knowledge of the deposit area is acceptable to reliably inform mine planning.

8 DEPOSIT TYPES

8.1 Overview

Red Chris is considered to be an example of a porphyry copper deposit with elevated gold values, characterized by the composition of its host rocks, its alteration, and its copper–gold signature, with only minor molybdenum. It is classified as belonging to the high-potassium calc-alkalic type of porphyry system, which includes several world-class deposits such as Bingham Canyon (Utah).

8.2 Porphyry Copper Deposits

The following discussion of the typical nature of porphyry-copper deposits is sourced from Sillitoe, (2010), Singer et al., (2008), and Sinclair (2007).

Porphyry copper systems commonly define linear belts, some many hundreds of kilometres long, as well as occurring less commonly in apparent isolation. The systems are closely related to underlying composite plutons, at paleo-depths of 5 km to 15 km, which represent the supply chambers for the magmas and fluids that formed the vertically elongate (>3 km) stocks or dyke swarms and associated mineralization.

Commonly, several discrete stocks are emplaced in and above the pluton roof zones, resulting in either clusters or structurally controlled alignments of porphyry copper systems. The rheology and composition of the host rocks may strongly influence the size, grade, and type of mineralization generated in porphyry copper systems. Individual systems have life spans of circa 100,000 years to several million years, whereas deposit clusters or alignments, as well as entire belts, may remain active for 10 million years or longer.

Deposits are typically semicircular to elliptical in plan view. In cross-section, ore-grade material in a deposit typically has the shape of an inverted cone with the altered, but low-grade, interior of the cone referred to as the “barren” core. In some systems, the barren core may be a late-stage intrusion.

Figure 8-1 shows a schematic section of a porphyry copper deposit illustrating the relationships of the lithocap to the porphyry body, and associated mineralization styles.

The alteration and mineralization in porphyry copper systems are zoned outward from the stocks or dyke swarms, which typically comprise several generations of intermediate to felsic porphyry intrusions. Porphyry copper–gold–molybdenum deposits are centred on the intrusions, whereas adjacent carbonate wall rocks commonly host proximal copper–gold skarns and less commonly, distal base metal and gold skarn deposits.

Beyond the skarn front, carbonate-replacement copper and/or base metal–gold deposits, and/or sediment-hosted (distal-disseminated) gold deposits can form. Peripheral mineralization is less conspicuous in non-carbonate wall rocks, but may include base metal- or gold-bearing veins and mantos.

Figure 8-1: Schematic Section, Porphyry Copper Deposit

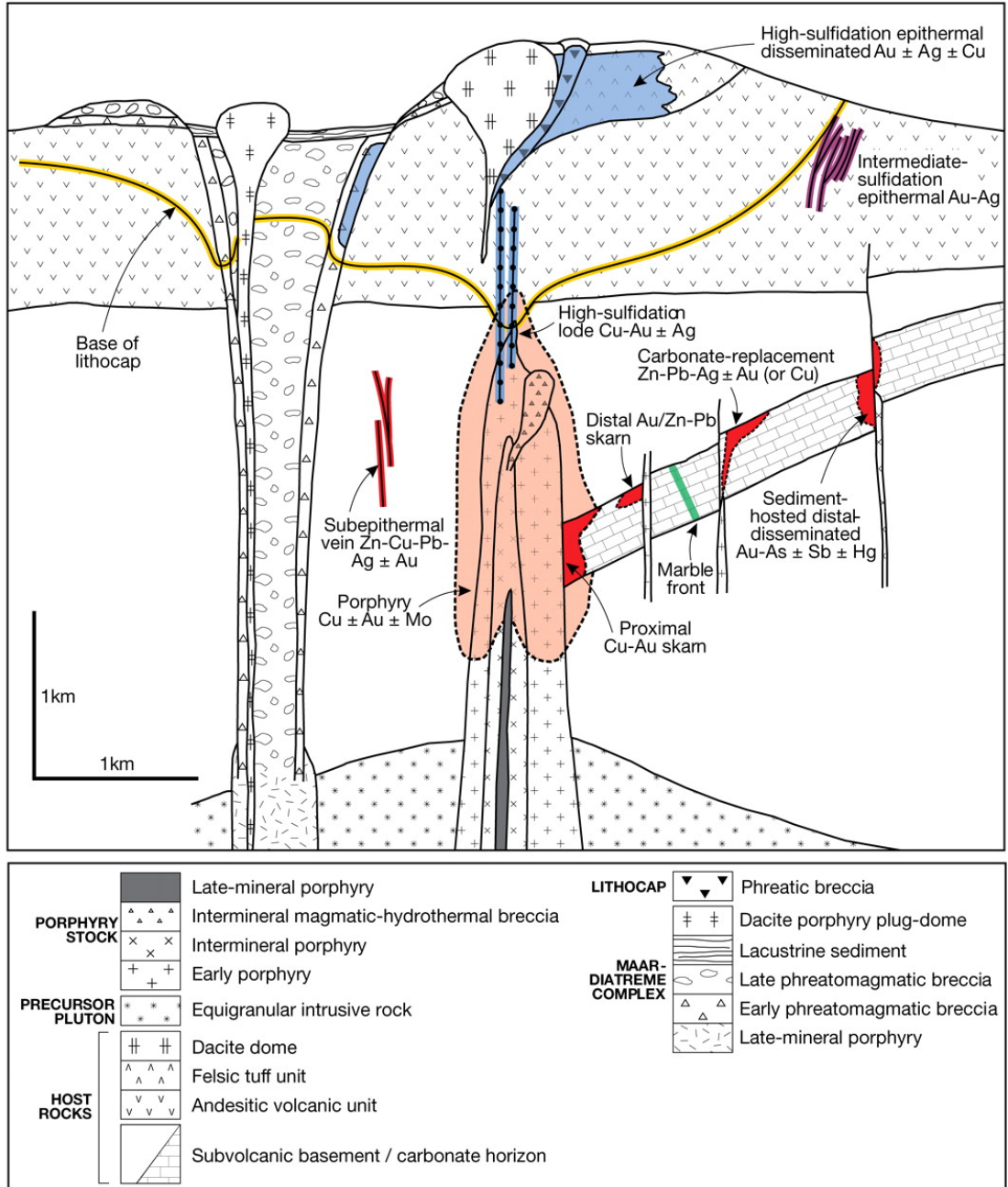

Note: Figure from Sillitoe, 2010.

Data compiled by Singer et al. (2008) indicate that the median size of the longest axis of alteration surrounding a porphyry copper deposit is 4–5 km, while the median size area of alteration is 7–8 km².

Alteration is typically zoned laterally from the core of the deposit and vertically. Figure 8-1 is a schematic illustration of alteration zoning and overprinting relationships in an idealized porphyry system. Alteration is defined by the alteration mineral assemblages that occur in each alteration zone. In silicate-rich rocks, the most common alteration minerals are K-feldspar, biotite, muscovite (sericite), albite, anhydrite, chlorite, calcite, epidote, and kaolinite. In the core of the deposit, alteration is typically potassic and consists of secondary K-feldspar, biotite, anhydrite, and quartz with possible bornite, chalcopyrite, gold, magnetite, and pyrite. Outward and upward from the potassic core, alteration includes argillic with various clay minerals, pyrite and chalcopyrite, propylitic with actinolite, epidote, chlorite, pyrite, carbonate, pyrite, and albite.

In carbonate rocks, the most common minerals are garnet, pyroxene, epidote, quartz, actinolite, chlorite, biotite, calcite, dolomite, K-feldspar, and wollastonite.

Other alteration minerals commonly found in porphyry-copper deposits are tourmaline, andalusite, and actinolite.

8.3 Red Chris

The Red Chris deposit was initially interpreted to be an example of an alkalic or “hybrid” alkalic deposit. Interpretations of chemical data on synmineral porphyry phases completed by Rees et al., (2015) suggests that the host porphyries are high-potassium, calc-alkalic in composition, similar to the monzonitic copper–(molybdenum–gold) class of porphyry deposits, which includes Bingham and Bajo de la Alumbrera. Red Chris is also classified as an A-vein type deposit, due to the strong control on higher-grade copper–gold by A-vein stockworks with abundant disseminated copper sulphides.

Whole rock analyses from early and intermediate stage porphyries in the Red Stock fall marginally on the calc-alkaline side of the alkaline/subalkaline divider, suggesting that Red Chris should be assigned to the high-K calc-alkalic category of Lang et al. (1994). However, late-mineral stage porphyries plot in the alkalic field. The mineralizing (intermediate-stage) quartz monzonite porphyries plot in the high-K calc-alkalic field.

In Seedorff et al.’s (2005) classification scheme, Red Chris conforms with their “monzonitic Cu (Mo–Au) class” of porphyry copper deposits. This class features an uncommon association of copper with both gold and molybdenum credits, although at Red Chris the molybdenum relationship with copper–gold is irregular.

Proffett (2009) recognized two types of porphyry-copper systems, based on differences in mineralization style (copper in A-type quartz veins versus copper in early-formed fracture halos), and the corresponding genetic correlation with a particular porphyry magma phase (a high versus a low correlation, respectively). He attributed the differences to depth of formation, and whether a two-phase or a single-phase fluid was responsible for sulphide behaviour. Red Chris has the hallmarks of an ‘A-vein type’

system, and probably formed at a relatively shallow level in the crust from a two-phase mineralizing fluid.

Mineralization related to magmatic–hydrothermal brecciation is not evident at Red Chris.

8.4 QP Comments on “Item 8: Deposit Types”

The QP considers the use of a calc-alkalic porphyry copper model for exploration programs is a reasonable basis for exploration targeting for copper–gold mineralization in the Project area. Skarn-style models are also applicable, although economic mineralization of the tenor of the porphyry deposits has not been identified to date.

9 EXPLORATION

9.1 Grids and Surveys

The grid and co-ordinate system used for the mining operations is UTM NAD83/9N.

Exploration activities away from the mine site use UTM NAD83/9N.

Topographic control is established from PhotoSat topographic data and derived digital elevation model. The data are considered accurate to within 15 cm.

9.2 Geological Mapping

Surface geological mapping was performed by Imperial Metals staff. Mapping was completed at a range of scales, from prospect (1:5,000) to regional (1:50,000).

9.3 Geochemical Sampling

9.3.1 Legacy

The term “legacy” is used to refer to all work conducted by companies other than Imperial and Newcrest.

A total of 934 samples were collected by unknown parties during regional reconnaissance, consisting of five rock chip, two silt, 31 soil and 896 samples of unknown methodology.

9.3.2 Imperial

A total of 188 B-horizon soil samples were collected from the Peggy mineral showing, located north of the open pit.

About 118 rock chip samples were collected from across the Red Chris porphyry corridor.

9.3.3 Newcrest

Since Newcrest assumed operatorship, geochemical samples collected included 128 soil samples collected across the East Ridge surface expression. Sample locations are shown in Figure 9-1.

Surface geochemical sampling has principally been used as a mineralisation vectoring tool to prioritise exploration prospects and generate direct drill targets.

Figure 9-1: Geochemical Sampling

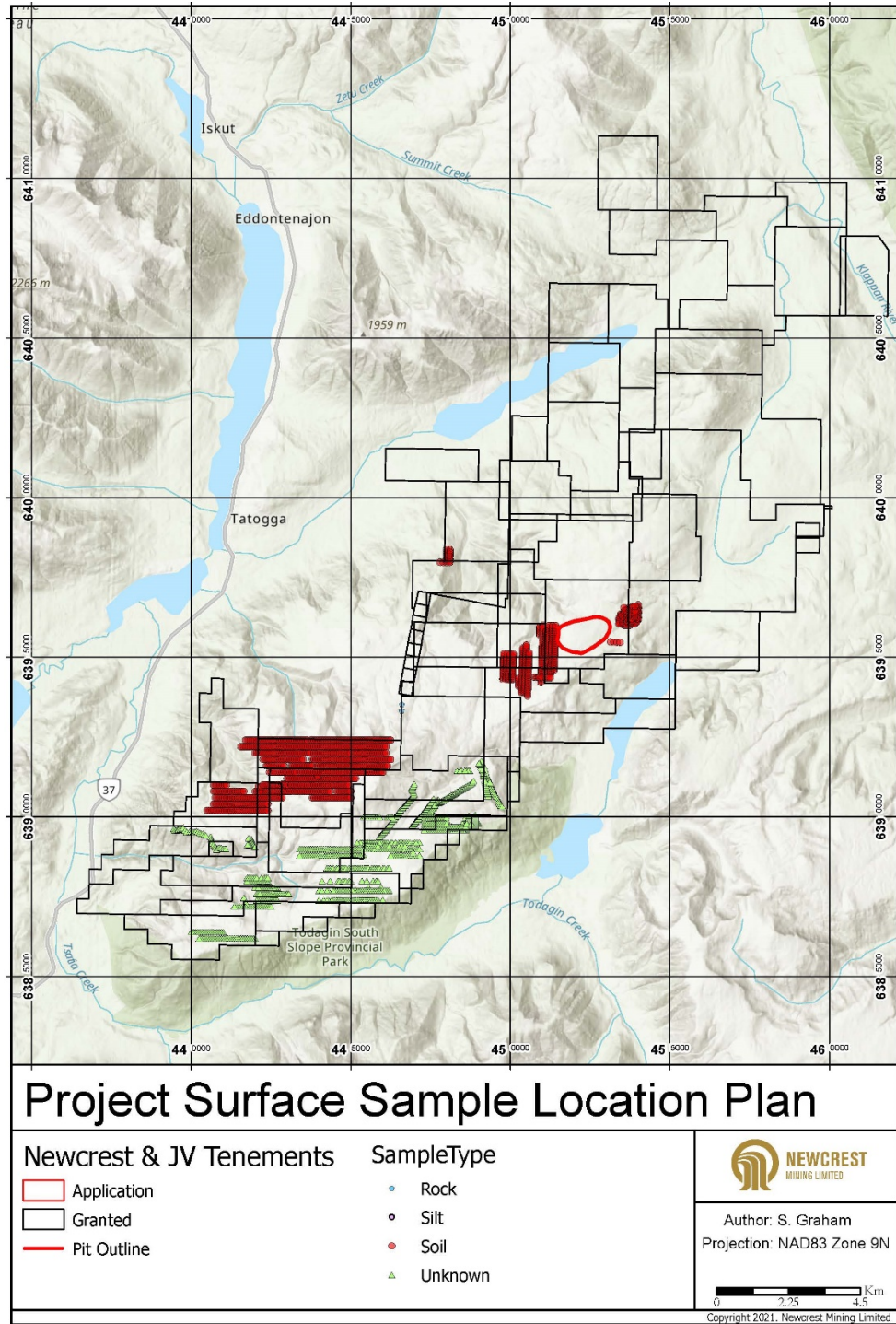

Note: Figure north is to top of map.

9.4 Geophysics

9.4.1 Legacy

In the period 1968–1970, Great Plains conducted ground magnetic and IP surveys as part of reconnaissance exploration activities. American Bullion completed ground magnetic and IP surveys, and an airborne VLF EM survey.

A series of conductivity and magnetic anomalies were generated.

9.4.2 Imperial

In 2009, Imperial undertook a Titan-24 deep imaging IP-MT geophysical survey, consisting of 13 north–northwest-oriented lines perpendicular to the orientation of the Red Stock, and extending into country rocks and structurally-overlapping rock units. This survey provided high-quality resistivity and chargeability imaging of the subsurface. A property-wide aeromagnetic survey was also completed, and field crews ran extensive proton ground magnetometer surveys over the Titan grid and throughout the Todagin plateau.

A series of conductivity and magnetic anomalies were generated, and number of these anomalies warrant drill follow-up.

9.4.3 Newcrest

In 2020, Newcrest undertook an airborne geophysical survey campaign. The campaign consisting of a combined airborne Z-Tipper axis electromagnetic (ZTEM) and gravity survey followed by an airborne magnetic survey. The airborne ZTEM and gravity surveys were completed across the entire Red Chris claim package at 250 m line spacing for a total of 1,922 line km. The airborne magnetic survey was completed across the northern and southern portion of the Red Chris claim package, complementing previous surveys at a 100 m line spacing for a total of 1,328 line km.

A series of anomalies including conductivity and magnetic were generated and will be followed up in future exploration programs.

9.5 Petrology, Mineralogy, and Research Studies

Multiple petrological studies were conducted as part of broader research studies and to directly understand the mineralogy of the Red Chris deposit. Petrology was completed on selected core and rock samples

Figure 9-2: Geophysical Surveys

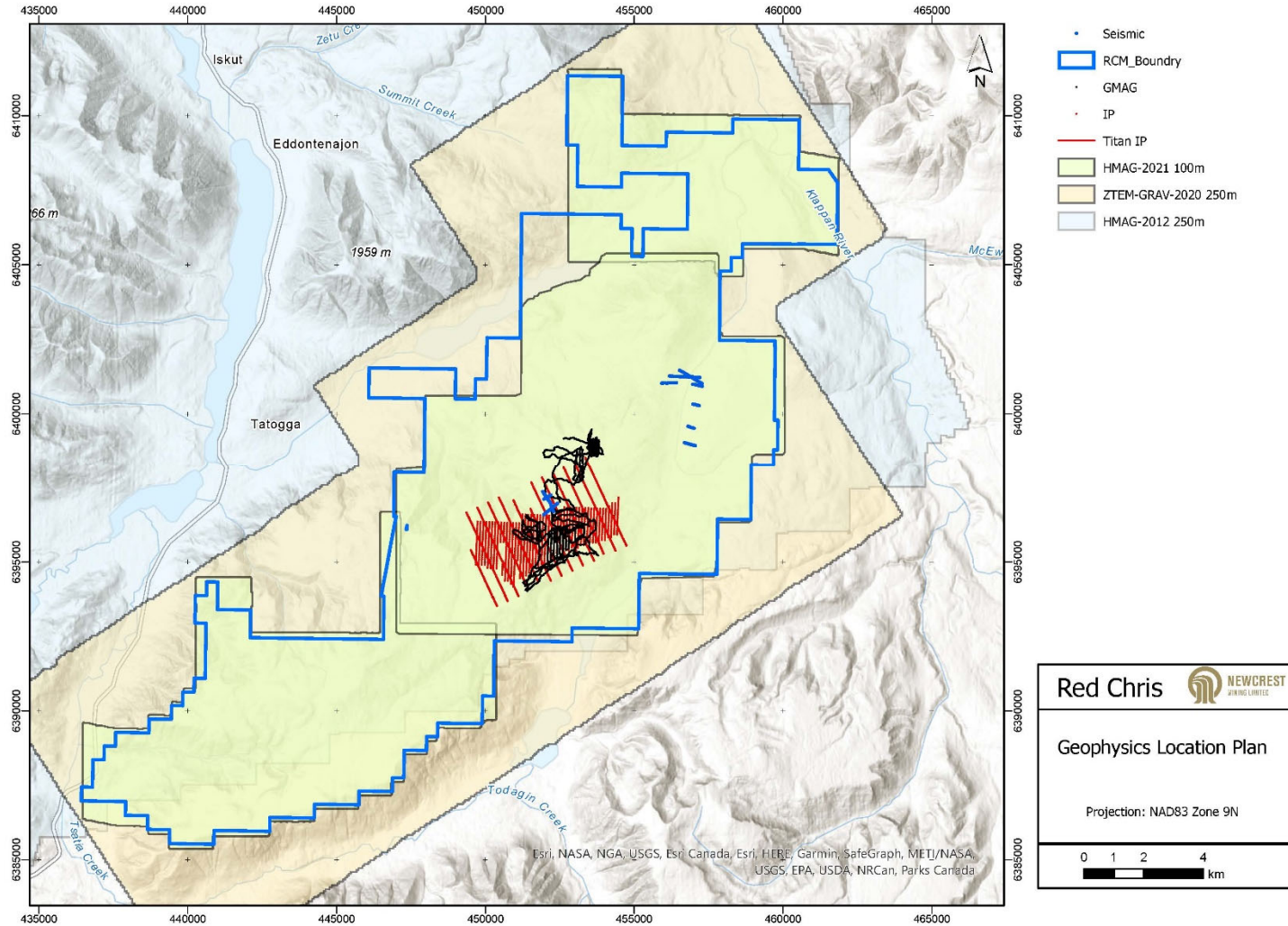

Note: Figure prepared by Newcrest, 2021.

Corescan infra-red and near-infra-red hyperspectral analyses were conducted on selected drill core. This technique provides accurate mineralogical information through very high-resolution scanning of the sample and use of specific algorithmic processing of the acquired spectra. This technique can be used to accurately identify hydrothermal alteration minerals that are not readily identifiable during geological logging. As the targeted mineralisation styles are well known to have predictably zoned hydrothermal alteration patterns around mineralised centres, being able to identify the mineralogical assemblages of drilling samples can be a useful tool for improving the understanding of the known deposit areas and vectoring towards deposits in exploration.

Research theses and major papers completed on the Red Chris deposit include:

- Norris, J.R., 2012: Evolution of Alteration and Mineralization at the Red Chris Cu-Au Porphyry Deposit East Zone, Northwestern British Columbia, Canada: M.Sc. thesis, Vancouver, Canada, University of British Columbia, 194 p.;
- Rees, C., Riedell, K.B., Proffett, J.M., Macpherson, J., and Robertson, S., 2015: The Red Chris Porphyry Copper-Gold Deposit, Northern British Columbia, Canada: Igneous Phases, Alteration, and Controls of Mineralization: *Economic Geology*, v. 110, pp. 857–888;
- Zhu, J-J, Richards, J.P., Rees, C., Creaser, R., DuFrane, S.A., Locock, A., Petrus, J.A., and Lang, J., 2018: Elevated Magmatic Sulphur and Chlorine Contents in Ore-Forming Magmas at the Red Chris Porphyry Cu-Au Deposit, Northern British Columbia, Canada: *Economic Geology*, v. 113, pp. 1047–1075.

9.6 Exploration Potential

9.6.1 Red Chris

A number of areas remain prospective at depth in the immediate vicinity of the open pit operation (Figure 9-3 and Figure 9-4):

- In the East Zone, drilling continues to confirm the potential for additional high-grade mineralisation south of the South Boundary Fault. The South Boundary Fault currently defines the southern extent of mineralisation across the East Zone, Main Zone and Gully Zone;
- In the Main Zone, drilling has confirmed the potential for further higher-grade mineralisation beneath and to the south west of the open pit. The mineralisation is located immediately adjacent to the South Boundary Fault and is open at depth and along strike. Drilling to define the extent and continuity of this potential high grade mineralisation is underway;
- In the Gully Zone, drilling has confirmed the potential for discrete zones of higher-grade mineralisation that will require follow up drilling to determine their full extent.

Figure 9-3: Near-Mine Targets

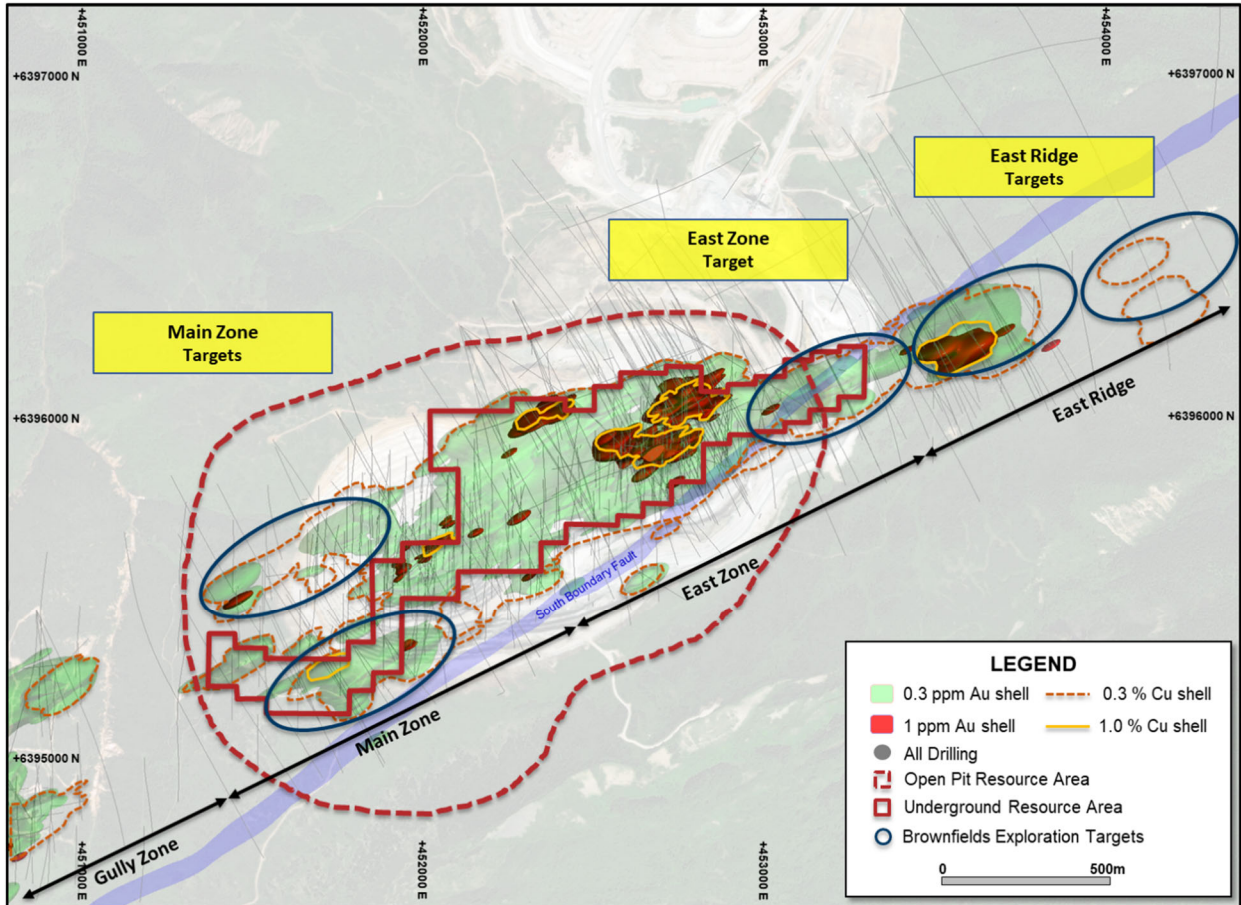

Note: Figure prepared by Newcrest, 2021.

Figure 9-4: Mineralization Long Section View

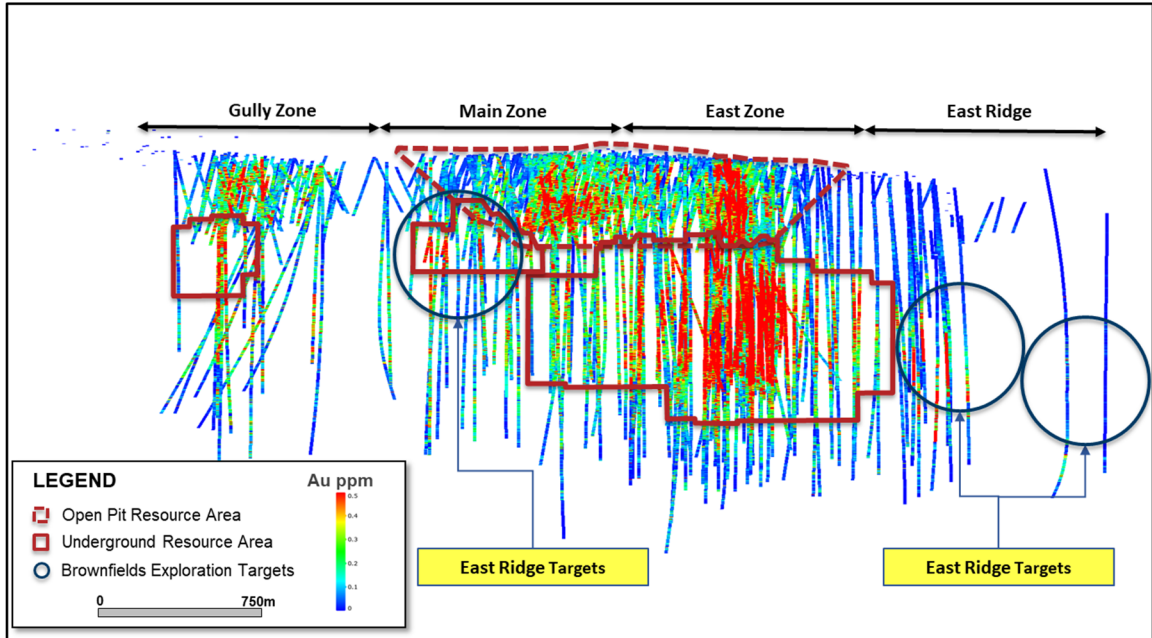

Note: Figure prepared by Newcrest, 2021.

The East Ridge discovery is located 300 m to the east of the East Zone (Figure 9-5). Drilling to date has demonstrated continuity of the East Ridge zone (>0.3 g/t Au over dimensions of 400 m high, 400 m long and 125 m wide, with the higher-grade (>1 g/t Au) portion now extending over an area of over 300 m high, 300 m long and 100 m wide. Mineralization is open to the east and at depth, and extends the eastern dimensions of the mineralized porphyry corridor.

9.6.2 Regional Prospects

No work has been completed by Imperial or Newcrest on the Red Chris South claims package. Bolero Resources Corp. completed 818 soil samples, 15 rock chip samples and four drill holes totalling 1,450 m in 2011. No evidence from drilling, rock and soil sampling, or prospecting gave direct indications of Red Chris-style copper–gold porphyry mineralization; however, drilling did not test beneath the Bowser Group cover sequence.

Figure 9-5: East Ridge, Oblique Schematic Section View

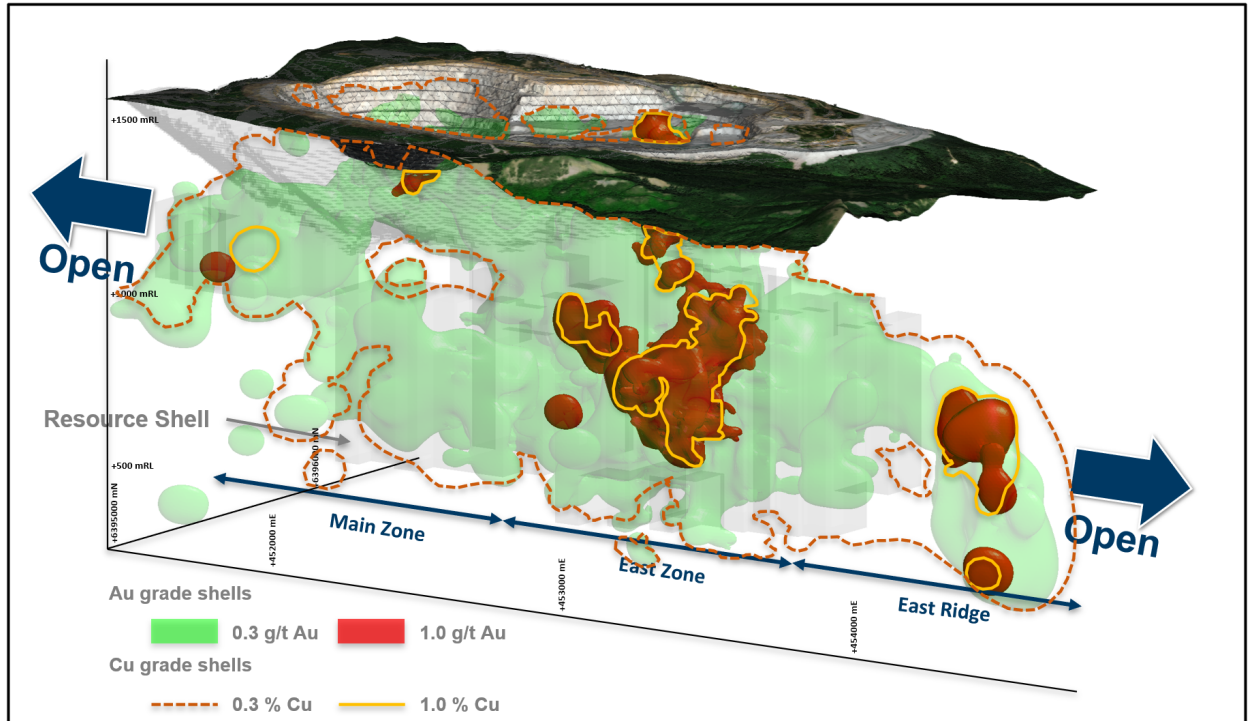

Note: Figure prepared by Newcrest, 2021.

9.7 QP Comments on “Item 9: Exploration”

In the QP’s opinion:

- The exploration programs completed to date are appropriate to the style of the deposits and prospects;
- Additional exploration has a likelihood of generating further exploration successes particularly depth extensions of known zones.

10 DRILLING

10.1 Introduction

Table 10-1 summarizes all drilling in the Project area to 30 September, 2021. Across all programs, a total of 1,477 drill holes and test pits (about 400,974 m), has been completed. Core drilling is the predominant drill type.

A total of 487 core holes (287,535 m) support the Mineral Resource estimates, from the Texasgulf, American Bullion, bcMetals (referred to as legacy drilling), Imperial, and Newcrest drill programs. (Table 10-2).

A total of 82 drill holes were removed from estimation support because the holes were drilled for geotechnical purposes; were <30 m in depth; or were drilled by bcMetals, and the assay results did not reflect the assay values from later drilling in the same area.

A Project-wide drill collar location plan is included as Figure 10-1. A drill collar location plan showing the drilling supporting the Mineral Resource estimates is provided in Figure 10-2, and a long-section showing the drilling is shown in Figure 10-3.

10.2 Drill Methods

Drill contractors and rig types are summarized, where known, in Table 10-3. Core sizes included PQ3 (83.1 mm core diameter) HQ (63.5 mm), HQ3 (61.1 mm), NQ (47.6 mm), NQ3 (45.1 mm), and BQTK (40.7 mm).

Core from inclined drill holes during the Newcrest drilling is oriented on 3 m or 6 m runs using an electronic core orientation tool (Reflex ACTIII or Boart Longyear Trucore). At the end of each run, the bottom of hole position is marked by the driller, which is later transferred to the whole drill core run length with a bottom-of-hole reference line.

10.3 Logging Procedures

10.3.1 Legacy

Geological logging procedures are not well documented for any program prior to 2003. Core recovery, and rock quality designation (RQD) were logged, and specific gravity measurements were completed. All data were entered into a computer database.

10.3.2 Imperial

Once drill core was received at the core shack, the core was washed and logged.

Geological logging consisted of qualitative descriptions of lithology, alteration, mineralisation, veining, and structure.

Table 10-1: Project Drill Hole Summary Table (as at 30 September, 2021)

Period	Company	Core		Percussion		Test Pits		Other		Total	
		# Holes	Metres	# Holes	Metres	# Pits	Metres	# Holes	Metres	# Holes	Metres
Unknown								3	202.10	3	202.10
1970–1972	Great Plains DC	10	1,095.20							10	1,095.20
1973–1980	Texasgulf	74	13,268.60	38	3,018.3					112	16,286.90
1994–1995	American Bullion	170	58,139.10			14	69.7			184	58,208.80
2003–2006	bcMetals	88	28,195.60			16	64.6			104	28,260.20
2007–2018	Imperial	642	117,951.18			120	500.3	131	3,311.00	893	121,762.48
2019–2021	Newcrest	171	175,158.07							171	175,158.07
Total		1,155	393,807.75	38	3,018.3	150	634.6	134	3,513.10	1,477	400,973.75

Table 10-2: Drill Holes Supporting Mineral Resource Estimate

Operator	Year	Number of Drill Holes	Metres Drilled
Texasgulf	1973–1980	71	13,117
American Bullion	1994–1995	167	57,783
bcMetals	2003–2006	80	26,920
Imperial	2007–2018	94	101,940
Newcrest	2019–2021	75	87,774
Total		487	287,535

Figure 10-1: Project Drill Hole Location Map

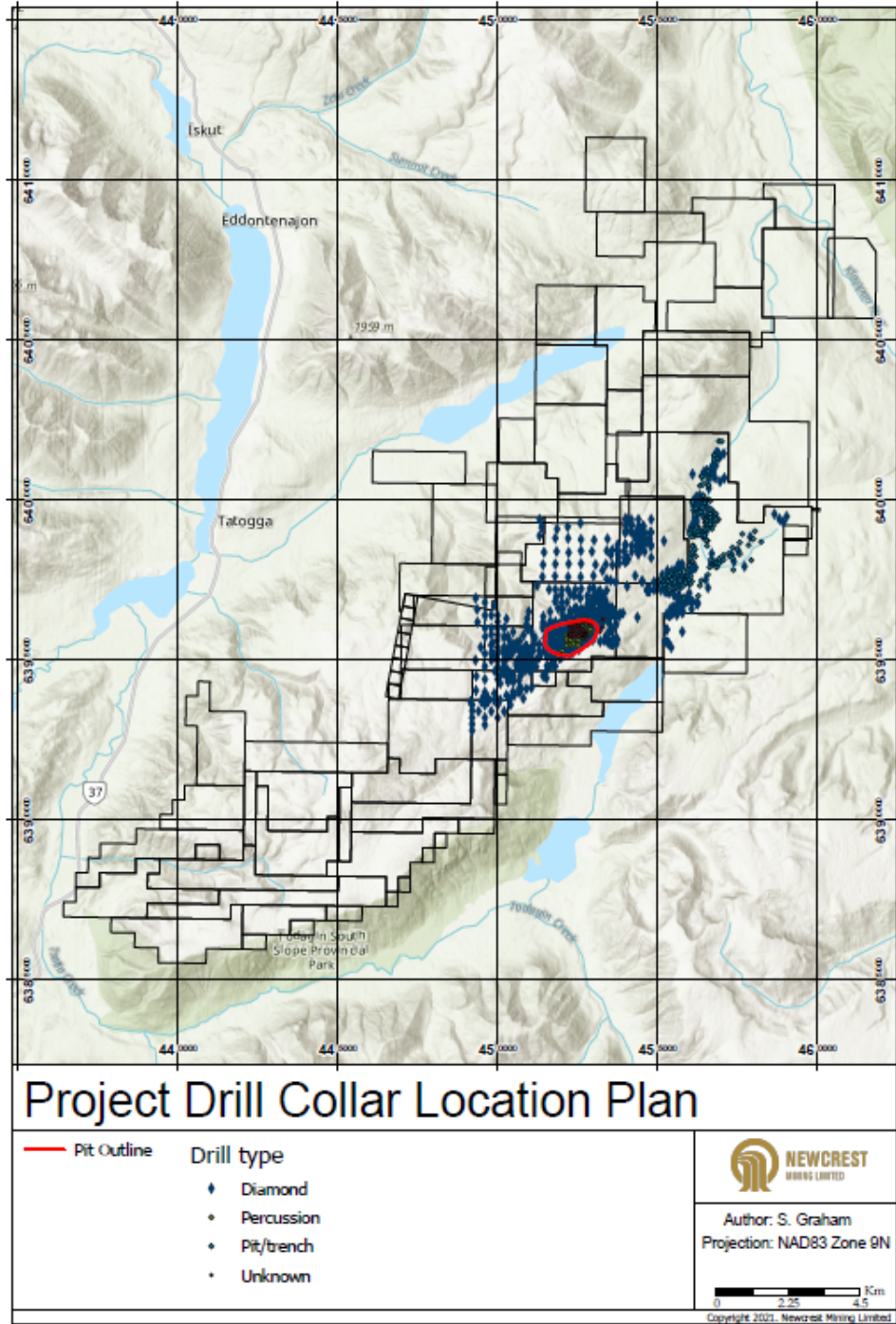
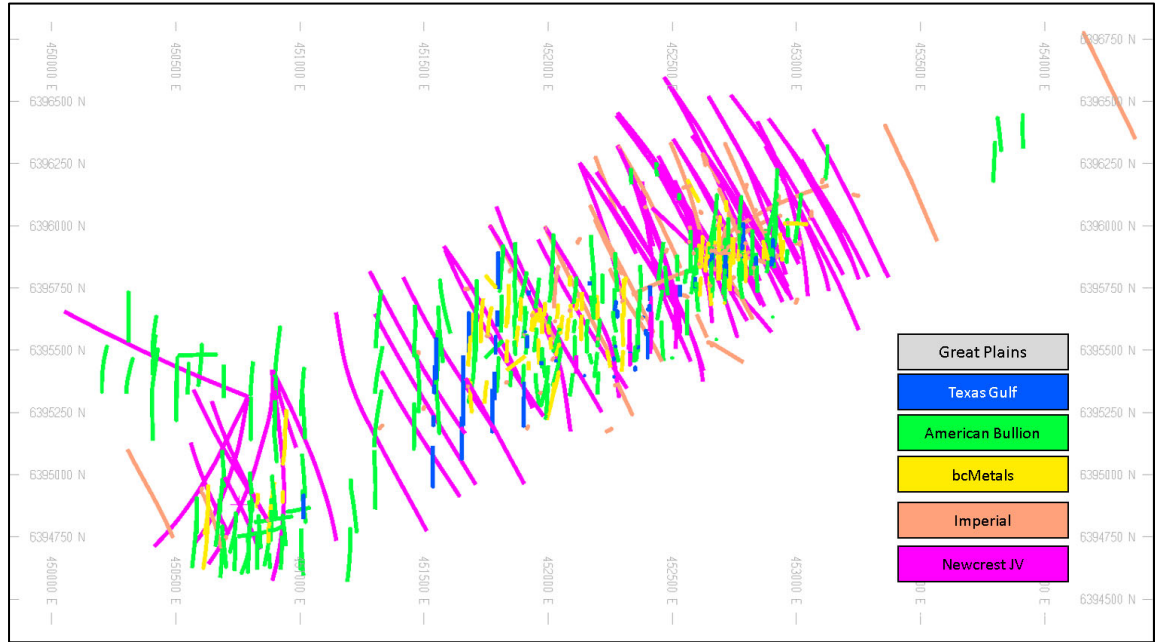

Figure prepared by Newcrest, 2021. Note: Figure north is to top of map.

Figure 10-2: Red Chris Drill Collar Location Plan View



Note: Figure prepared by Newcrest, 2021.

Figure 10-3: Red Chris Drill Collar Location Long-Section

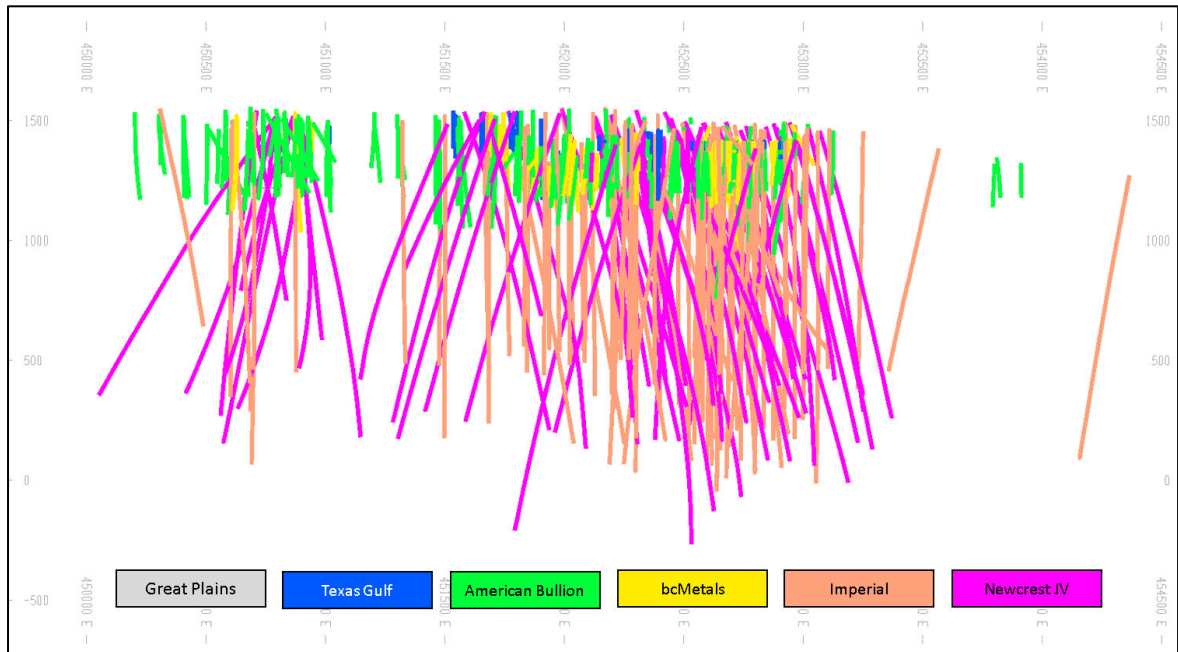

Note: Figure prepared by Newcrest, 2021.

Table 10-3: Drill Methods

Operator	Drilling Contractor	Method and Drill Type
Conwest, Great Plains, Ecstall, Texasgulf	Unknown	Diameters and machinery not recorded
American Bullion	J.T. Thomas Diamond Drilling Ltd. of Smithers, British Columbia	Skid-mounted Longyear Super 38 and Longyear 44 drill rigs
Red Chris Development Company Ltd.	Hy-Tech Drilling Ltd. of Smithers, British Columbia (Hy-Tech)	Skid-mounted Hy-Tech 5000 and HY-Tech 4000 drilling rigs
Imperial	Atlas Drilling Ltd	Boyles 56, Boyles 37, Boart Longyear LF-230 drilling rig
Newcrest	Hy-Tech	Tech5000

The geotechnical data collected included core recovery, rock quality designation (RQD), fracture counts, core strength, and overall ratings, with special attention paid to the occurrence of slickensides and fault gouge.

The core was also logged with a KT-9 magnetic susceptibility instrument over every sample interval. Ten susceptibility readings were taken for each sample, and then averaged. Geology data were recorded into the commercially-available Northface Logger software, a database program designed for exploration drilling.

10.3.3 Newcrest

Geological logging using Toughbook computers recorded qualitative descriptions of lithology, alteration, mineralisation, veining, and structure, including orientation of key geological features.

Geotechnical measurements were recorded included RQD, fracture frequency, solid core recovery, and qualitative rock strength measurements.

Magnetic susceptibility measurements were recorded every metre.

All geological and geotechnical logging was conducted at the Red Chris mine site.

Digital data were captured, validated and stored in an acQuire database.

All drill cores were photographed, prior to cutting and/or sampling the core.

10.4 Recoveries

The recovery recorded by Imperial at Red Chris is close to 100% and the sample quality is considered to be excellent. The sampling does not result in any biases and is representative of the areas drilled.

During the Newcrest programs, core recovery was systematically recorded from the commencement of coring to the end of the hole, by reconciling against driller's depth

blocks in each core tray with data recorded in the database. Drillers' depth blocks provided the depth, interval of core recovered, and interval of core drilled.

Core recoveries were typically 100%, with isolated zones of lower recovery associated with fault zones.

10.5 Collar Surveys

10.5.1 Legacy

In 2003, proposed drill hole sites were surveyed in by McElhanney Consulting Services Ltd. using a total station instrument and established property grid controls. The final drill hole collar locations were surveyed by McElhanney using both a total station and a survey quality global positioning system (GPS) instrument.

10.5.2 Imperial

Imperial drill hole collars were surveyed with a handheld Garmin 60csx GPS.

10.5.3 Newcrest

Drill collar locations were surveyed using a RTK GPS with GNSS with a stated accuracy of $\pm 0.025\text{m}$. Drill rig alignment was attained using an electronic azimuth aligner (Reflex TN14 GYROCOMPASS).

10.6 Downhole Surveys

10.6.1 Legacy

In 2003, the drill contractor, Hy-Tech Drilling, was responsible for all down-hole surveys. Two systems were used, with the Reflex digital magnetic instrument being the primary survey system and the Accushot photo system as a backup in case of Reflex breakdown or unavailability. Twenty-four of the 235 down-hole surveys were deemed unacceptable due to incorrect azimuth readings and were rejected. Blocked bits and operator error were responsible for most survey failures.

10.6.2 Imperial

Down hole surveys were periodically conducted using a Reflex EZ-Trac downhole probe. Measurements were taken every 9.14 m (three rods), with the probe suspended by aluminium running gear 7.0 m beyond the drill bit. Magnetic interference of the EZ-Trac is negligible at Red Chris due to the low amount of magnetite. Data recorded at each survey station included azimuth, dip, temperature, and magnetic field strength.

10.6.3 Newcrest

Downhole surveys were collected at 9–30 m intervals using single shot survey instruments, either Reflex EZ-SHOT or Boart Longyear TruShot tool. At the end of the

drill hole, all holes were surveyed using a continuous Reflex EZ-GYRO gyro survey instrument to surface.

After the final hole survey, the single shot priorities were downgraded in priority and the continuous data assigned a priority of 1 for final hole plotting.

10.7 Geotechnical and Hydrological Drilling

A 2003 geotechnical drill program was completed to provide design parameters for the proposed pit slopes, plant site foundations, WRSF, low-grade stockpile, and the TIA, and included:

- Pit area: nine orientated, inclined core holes (2,499 m);
- WRSF site: two shallow (approximately 35 m) inclined drill holes and six test pits;
- Plant site: two shallow vertical drill holes (approximately 35 m), two test pits;
- TIA site: Four core holes (210 m), 16 test pits.

Selected drill holes had 1" standpipe piezometers and 2" groundwater monitoring wells installed.

A second program was completed in 2009, consisting of four geotechnical holes in the newly-proposed plant site area, two geotechnical holes in potential crusher site areas, and two geotechnical holes in the valley bottom of the TIA site. Additional information was collected from three embankment cuts along the TIA access, data from previously-installed groundwater monitoring wells and piezometers, and from site material mapping.

A 2010 program comprised 41 drill holes (1,888.48 m) at plant and TIA sites, and areas designated as potential borrow material sites.

Geotechnical and hydrological considerations in support of mining activities are discussed in Section 16.

10.8 Grade Control

Grade control spacing is carried out at a nominal 9 x 9 m spacing, with hole depths of approximately 12 m. Drill holes are completed using Atlas Copco PV351 and CM780D blast hole rigs.

10.9 Drilling Completed Since Close-out Date for Database Supporting Mineral Resource Estimate

The database for resource estimation was closed as of 1 July, 2021. A total of 127 core holes (approximately 128,357 m) was drilled to 30 September 2021. This drilling focused on areas outside of the Mineral Resource estimate, and was primarily completed for exploration purposes in the new East Ridge discovery and for geotechnical support of the proposed underground infrastructure. Drilling was ongoing at the Report effective

date. All exploration drilling was logged and sampled. Geotechnical drilling was logged and sampled if required, and when made available.

In the QP's view the few new drill holes that will intersect the area of the current Mineral Resource estimate will have no material effect on the overall tonnages or average grades of the current Mineral Resource estimate.

10.10 Sample Length/True Thickness

Drill spacing varies in the deposit ranging from approximately 50 x 50 m in the better drilled deposit areas in the East zone to about 100 x 200 m spacing on the less well drilled portions of the deposit in the Gully zone.

The term "true thickness" is not generally applicable to porphyry-style deposits as the entire rock mass is potentially mineralised and there is often no preferred orientation to the mineralisation. In areas that display porphyry-style mineralisation, in general, most drill holes intersect mineralised zones at an angle, and the drill hole intercept widths reported for those drill holes are typically greater than the true widths of the mineralisation at the drill intercept point.

10.11 QP Comments on "Item 10: Drilling"

In the opinion of the QP, the quantity and quality of the logged geological data, collar, and downhole survey data collected in the Texasgulf, American Bullion, bcMetals, Imperial and Newcrest exploration and infill drill programs are sufficient to support Mineral Resource and Mineral Reserve estimation and mine planning as follows:

- Core and RC logging meets industry standards for copper and gold exploration;
- Collar surveys have been performed using industry standard instrumentation at the time the drill program was conducted;
- Downhole surveys were performed using industry standard instrumentation at the time the drill program was conducted;
- Recovery data from core and RC drill programs are acceptable;
- Drill orientations are generally appropriate for the mineralization style and the orientation of mineralization for the bulk of the deposit area (refer to Figure 9-4);
- Drilling has generally been done at regularly-spaced intervals and is considered representative of the deposit. Drilling was not specifically targeted to the high-grade portions of the deposit, rather, a relatively consistent drill spacing was completed.

11 SAMPLE PREPARATION, ANALYSES, AND SECURITY

11.1 Sampling Methods

11.1.1 Core Sampling

11.1.1.1 Legacy

1956 to 1994

There is no information available on the earliest drill sampling programs.

1994–1995

Drill core was split in half lengthwise using a Longyear manual splitter and sampled between drilling length blocks; usually at 3.05 m (10 ft) intervals. A duplicate sample of every 20th sample was inserted into the sampling sequence as a ‘blind’ check-assay sample duplicate. All samples were labelled, double-bagged and flown to a secure landing and collection site at Tatogga Lake Resort, situated on Highway 37.

2003–2004

The length of the sampled interval depended upon geological rock contacts, core size, and changes in mineral intensity, but generally averaged 3 m with NQ core and 2 m with HQ core. The core was split in half lengthwise using a Longyear manual splitter and half the sample, between the assay interval tags, was placed in labelled, tagged, double-bagged plastic sample bags. These were placed in rice bags (nominally five samples per rice bag) and shipped to a secure site at Tatogga Lake Resort.

11.1.1.2 Imperial

From 2007 to August 2019, drill core was delivered directly from the drill to the core shack where geological and geotechnical logging was completed. Sample intervals were marked at 2.5 m (maximum) intervals starting from zero, or less if required by major geological contacts. Where a geological contact affected the grade distribution, the geologist would mark a sample contact at the geological contact as well.

Sample tags were filled out and inserted into the core box by a geologist. The marked and tagged core were photographed and then cut axially with a rock saw (rarely with a hydraulic splitter). One half of the cut core was placed in a clear poly-ore bag with a sample tag and zap-strapped. The other half remained in the core box for storage on site in sturdy wooden racks.

Sample bags were placed into plastic white rice bags, driven to Iskut and stored on pallets in a locked container at the Bandstra Depot. Samples were shipped via Bandstra to the Acme Analytical (Acme) preparation laboratory in Smithers.

11.1.1.3 Newcrest

Core was cut and sampled at the Red Chris Operations core processing facility. PQ, HQ and NQ diameter cores were drilled on a 3 m or 6 m run. Core was cut using a manual or automatic core-cutter and half core sampled at 2 m intervals. Cover sequences were not sampled.

Half-core samples were collected in plastic bags together with pre-numbered sample tags and grouped in plastic bags for dispatch to the laboratory. Sample weights typically varied from 5–10 kg, and sample sizes are considered appropriate for the style of mineralisation. Drill core samples were freighted by road to the laboratory.

11.1.2 Ore Control (Blasthole) Sampling

Blasthole sampling is conducted in the open pit on the cone of material produced when drilling an open hole percussion hole, approximately 311 mm diameter to a depth of approximately 12 m. This generates approximately 2 t of sample.

Sampling is carried out with a push tube (pipe spear) manually inserted into the blast cone at 4–5 locations and deposited in a calico bag for an approximate 2–3 kg sample.

11.2 Density Determinations

In 1994–1995, 6,934 specific gravity measurements were recorded at 8 m intervals. The method used is not reported.

In 2003, 134 15-cm-long core samples were selected for specific gravity testing at the University of British Columbia Mining and Mineral Process Engineering Group. The process used to measure bulk density was ASTM C97 – Standard Test Methods for Absorption and Bulk Specific Gravity of Dimension Stone, with the following deviations:

- Several core samples received with 46 mm diameter, undersized for 2" (50.4 mm) minimum dimension for test,
- Samples heated at 110°C for 48 hours (standard designates 60°C same time period).

These deviations from the standards were not considered to impact the testwork results.

The current database holds a total of 7,311 historical dry density measurements that were undertaken by Acme on 10 cm long whole-core samples on a nominal 100 m downhole spacing. Acme used the following equation to determine the bulk density:

- $\text{Dry weight in air} / (\text{Wet weight in air} - \text{Wet weight in water})$.

Newcrest is currently undertaking validation measurements from an infill drilling program within the East zone using the Archimedes method on whole-core samples on a nominal 30 m downhole spacing. Newcrest is also currently taking specific gravity measurements using the Archimedes method at 100 m downhole spacing on step-out exploration drilling.

11.3 Analytical and Test Laboratories

A number of laboratories were used during the exploration and operational history:

- Min-En Laboratories in Smithers, BC (Min-En), used as the primary laboratory in 1994–1995; independent. Accreditations during the time used are not recorded in the Project database;
- Chemex Laboratories Ltd., North Vancouver, BC (Chemex); used as check laboratory for Min-En work; independent; accreditations at the time not recorded in the Project database;
- International Plasma Laboratory Ltd. in Vancouver BC (IPL), used as the primary laboratory in 2003–2004, independent, held ISO 9002 registration;
- ALS Chemex, Vancouver, BC (successor to Chemex; ALS Vancouver); used as check laboratory for IPL work; independent; accreditations at the time not recorded in the Project database;
- Acme, used as the primary laboratory in 2011–2012, independent. From 2007 to 2010, samples were prepared at Acme Smithers, BC and analysed at Acme Vancouver. Acme has been ISO 9001 certified since 1996. Acme Vancouver obtained ISO 17025 accreditation for selected analytical techniques in 2011;
- Bureau Veritas Commodities Canada Ltd. in Vancouver, BC (Bureau Veritas; formerly Acme), used as the primary laboratory from 2019, independent. Holds ISO 17025 accreditation for selected analytical techniques;
- ALS Vancouver, used as check laboratory for Bureau Veritas work; independent. Holds ISO 17025 accreditation for selected analytical techniques;
- Mt Polley mine laboratory, used from 2011–2012; not independent and is not accredited;
- Red Chris mine laboratory, used for grade control drilling in the open pit; not independent and is not accredited.

11.4 Sample Preparation

Sample preparation and analytical methods have some variations over time. Typically, the following were used:

- Min-En: samples were dried, crushed to minus ¼ inch, and pulverized to 95% passing 150 mesh;
- IPL: samples were dried, crushed to -10 mesh, and pulverized to 95% passing 150 mesh;
- Acme: samples were dried, crushed to 80% passing a nominal 3–5 mm, and pulverized to 85% passing 200 mesh;

- Bureau Veritas: samples were dried at 65°C, crushed to 95% passing 4.75 mm, and pulverised to 95% passing 106 µm.

11.5 Sample Analysis

Analytical methods varied with time (Table 11-1).

11.6 Quality Assurance and Quality Control

11.6.1 Legacy

The 1994–1995 program used a standard reference material (standard) and a blank as quality assurance/quality control (QA/QC) measures. Results from the standard were required to be within two standard deviations (SD) of its best value or the whole batch was reassayed.

Approximately 10% of the submitted samples were assayed in duplicate. Selected samples were re-assayed by Chemex for copper and gold, using similar methods to those of Min-En.

The 2003 program used three in-house standards and blanks. Approximately one in every 20 samples from IPL were re-assayed at Chemex. At Chemex these pulps were then renumbered with a random number sequence to produce a set of 'blind' samples that were then sent back to IPL for re-analysis. A selected set of higher-grade samples from the first hole drilled in 2003 (03-248) were sent to Acme for re-analysis. A second sampling of half-cores for analysis at IPL was completed to provide an indication of inherent geological (short range sampling) variability.

11.6.2 Imperial

During 2007–2012, standards, duplicates, and blanks were randomly inserted within every 17 consecutive core samples. Three custom standards were used, prepared from material at Imperial's Mt Polley deposit. The duplicates were prepared from quartering the half-core sample at the time of cutting or splitting. Blanks consisted of crushed rock from a highway gravel pit located along the Likely highway in the central interior of British Columbia.

If a blank sample returned copper and gold assay values over a pre-determined threshold (0.05% Cu and 0.05g/t Au), the blank reject along with at least 10 sequential core rejects (above and below the blank) would be re-processed and re-assayed. If the re-processed reject failed to meet the QA/QC requirements, the half-core was quartered and new samples in the affected range were re-submitted to the laboratory for processing and assaying. The majority of the blank samples assayed at or below the detection limit.

Table 11-1: Analytical Methods

Laboratory	Analytical Method
Min-En	<p>0.5–2 g aliquot dissolved in a three-acid mixture and finished on an atomic absorption spectrometer (AAS). If any assays were >1% copper they were re-assayed at a lower weight. A small portion of the core samples were analysed for copper using a 0.5 g sub-sample with aqua regia digestion and AAS finish.</p> <p>Gold was assayed using one assay ton sample weights. Sub-samples were fluxed and a silver inquart was added and mixed. After fusion and cupellation, the beads were dissolved in aqua regia and finished with an AAS. Detection limit of 0.2 g/t Au. Selected samples were analysed using a 31-element suite via inductively coupled plasma (ICP).</p>
IPL	<p>Four-acid digest; with an AAS finish. Copper assays greater than the in-house standard were diluted and re assayed. Copper values are reported in percent with a lower detection limit of 0.01% Cu.</p> <p>Gold assayed using fire assay on a 30 gram or one assay ton sample weight. The sub-samples were fluxed and a silver inquart was added and mixed. After fusion and cupellation, the beads were dissolved in aqua regia and finished on an AAS. Any gold assays >1 g/t were re-run by fire assay with a gravimetric finish. Detection limit of 0.01 g/t.</p> <p>Selected samples were analysed using a 30-element suite via ICP.</p>
Acme	<p>Copper and iron were analysed by ICP-emission spectroscopy (ES) with an aqua-regia digestion (Group 7AR).</p> <p>Gold was determined on a 30 g sample by fire assay with an ICP- atomic emission spectroscopy (AES) finish (Group 6).</p> <p>Selected samples were analysed using a 36-element geochemistry suite, including silver, via ICP- mass spectrometry (MS) with an aqua regia digestion (Groups 1DX).</p>
Bureau Veritas	<p>All samples were assayed for 48 elements using a 4-acid digestion followed by ICP-AES/ICP-MS determination (method MA250). Gold analyses were determined by 50 g fire assay with ICP-ES finish (method FA350). Carbon and sulphur were determined by Leco (method TC000) and mercury using aqua regia digestion followed by ICP-ES/MS determination (method AQ200).</p>

11.6.3 Newcrest

The Newcrest QA/QC program consisted of the insertion of standards, blanks, and duplicates into the sample stream. Sieve checks were also conducted.

Newcrest conducted a detailed QA/QC review of the data in the database as at end-February 2021. Drilling reviewed were primarily from the Imperial (2007–2018) and Newcrest (2019–2021) campaigns.

The frequency of QA/QC assaying (19.1% of primary assays) exceeded the planned compliance of 17.5% of the primary assays.

Particle sizing was undertaken after the two stages of comminution at the laboratory. For both crushing and pulverising this was undertaken at roughly twice the frequency specified. For the combined 8,703 tests only seven crush sizing failures were recorded

from the early batches. The compliance for achieving crush and pulverising sizing is very good.

Blanks were inserted at a nominal 1:40 rate to check for contamination and smearing. A total of 41 failures for gold out of 1,356 blank assays were noted with a maximum of 117 ppb Au. Investigations found that there were no adjacent high-grade samples that suggest smearing or contamination. Given the relatively low level of the gold grades the batches were accepted. Copper blanks showed some smearing in December 2019 in the first batches submitted and minor issues have been investigated.

Crush and pulp duplicates were collected by the laboratory at a higher frequency than the 1:20 required. In addition, the Bureau Veritas laboratory reported pulp replicates (same packet, same batch) as well as the pulp duplicates (different packet, same batch). All crush, pulp and replicate duplicates performed better than the target Newcrest Corporate Guidelines for precision.

Commercially available standards were sourced to cover the gold and copper ranges expected. Geologists selected the standards appropriate for the grade interval at a frequency of 1:20 from a library of four standards. Assay batch review was undertaken by site geologists before loading the results into the Acquire database. Any issues or concerns were noted in the Sharepoint-hosted "Issues Register", including two cases where batch re-assays were requested. In both cases the primary assays were accepted as the re-assays were similar. Z-score charts were used to monitor standards performance on a weekly and monthly basis

Gold standards demonstrate a 1.49% positive bias and individual standard plots show one (of the four) standards has been the main cause of the long-term bias. This is the lowest-grade material, just above the 20 times detection limit. The other three standards performed well with a local exception in late October 2020 when another standard also began showing a positive bias. Trend analysis of this bias lead to a written response from the laboratory and extensive discussion during a laboratory inspection in November 2020.

Copper standard Z-scores were plotted for the two ICP methods. This shows that the three lower-grade standards are assayed by MA250 and all show the negative bias. The MA370 CRM performance is informed by one standard that shows no bias. In a similar way to the gold bias, the laboratory has undertaken an investigation report and had discussions with Newcrest during the November 2020 laboratory inspection. This work will continue and will benefit from the use of matrix-matched CRMs rather than the current supply of commercially-available standards.

The sulphur standard charting for the ICP method shows a strong negative bias. The data used in Mineral Resource estimation is collected by infra-red combustion and the standards are not certified for this method. The non-matrix matched standards have presented some problems during QA/QC monitoring.

The sulphur and associated carbon assays are expected to be better supported by matrix-matched standards. In lieu of this, the second laboratory assays will give some measure of the sulphur and carbon assay accuracy.

Assayed pulps from the primary laboratory, Bureau Veritas, were auto-selected by an acQuire database algorithm to provide a grade coverage >100 ppb Au and >40 ppm Cu. Two anonymous batches were prepared, one returned to the primary laboratory and one sent to ALS Vancouver, an independent laboratory. The primary laboratory checks performed well against target precision of CV%AVR <15 for gold and <12 for copper, with calculated values of 7.7% and 3.2% respectively. Sulphur by ICP also performed well with a CV%AVR of 6.4% that improved to 4.1% when sulphur was analysed by infra-red combustion. Second laboratory checks also performed well with target precision of CV%AVR <18 for gold and <14.5 for copper, with calculated values of 7.7% and 3.6% respectively. Sulphur by ICP also performed well between laboratories with a CV%AVR of 4.5%. The second laboratory gold precision of 7.7% is the same as the precision reported for primary laboratory resubmission.

Overall, the dataset is acceptable for use in preparing a Mineral Resource estimate for gold and copper.

11.7 Databases

Assay and geological data are electronically loaded into acQuire and the database is replicated to Newcrest's centralised database server. The geological team on-site currently manages all data. Data are collected from geotechnical logging, geological logging and drilling data (collar, survey) and imported/logged directly into the acQuire database.

Exclusive control over the checking and entry of analyses from the laboratory is restricted to database administrator(s) and designated geologists at Red Chris. Log-in and access permissions are limited to control access to the database and to maintain the integrity of the resource data. Data access is generally limited to project geologists and the database administrators.

Additional information on data verification is included in Section 12.

The database is regularly backed up, and copies are stored in both offsite and in Newcrest facilities.

11.8 Sample Security

Sample security at the Red Chris Operations has not historically been monitored. Sample collection from drill point to laboratory relies upon the fact that samples are either always attended to, or stored in the locked on-site preparation facility, or stored in a secure area prior to laboratory shipment.

Chain-of-custody procedures consist of sample submittal forms to be sent to the laboratory with sample shipments to ensure that all samples are received by the laboratory.

Chain-of-custody management was achieved through solid boxing of samples with tamper proof tags.

11.9 Sample Storage

Core samples drilled before 2019 are stored as half and full core within wooden trays at the Red Chris Exploration core yard. Older core has degraded due to weather conditions and many drill holes are no longer available. Newcrest core drilled from 2019 onwards is stored at the same facility and top trays are covered with wooden lids to provide some weather protection.

No laboratory crush reject samples are retained from the pre 2019 drill programs. Newcrest core assayed at Bureau Veritas Vancouver from 2019 has the crush reject material retained at Bureau Veritas Vancouver.

Pulp (nominal 300g packets) retained for some programs before 2019 are stored at the Red Chris core yard. Bureau Veritas Vancouver store all of the Newcrest pulp retained packets after 2019.

No RC samples are retained at the core yard.

11.10 QP Comments on “Item 11: Sample Preparation, Analyses, and Security”

In the opinion of the QP, the sample preparation, analysis, and security are acceptable, meet industry-standard practice, and are adequate to support Mineral Resource and Mineral Reserve estimation and mine planning purposes, based on the following:

- Drill sampling was adequately spaced to first define, then infill, copper and gold anomalies to produce prospect-scale and deposit-scale drill data;
- Sample preparation for core samples has followed a similar procedure since 2007. The preparation procedure is in line with industry-standard methods;
- Analytical methods for core samples used similar procedures for the 2007–2021 core drill programs. The analytical procedure is in line with industry-standard methods;
- QA/QC submission rates are typical for the time of collection, and do not indicate any problems with the analytical programs, therefore the copper and gold analyses from the core drilling are suitable for inclusion in Mineral Resource estimation;
- Imperial and Newcrest used a QA/QC program comprising blank, CRM and duplicate samples. The QA/QC submission rate meets current industry-accepted standards of insertion rates;
- Data collected were subject to validation, using inbuilt program triggers that automatically checked data on upload to the database;
- Verification is performed on all digitally-collected data on upload to the main database, and includes checks on surveys, collar co-ordinates, lithology, and assay data. The checks are appropriate, and consistent with industry standards;
- Sample security has relied upon the fact that the samples were always attended or locked in the on-site sample preparation facility. Chain-of-custody procedures

consist of filling out sample submittal forms that are sent to the laboratory with sample shipments to make certain that all samples are received by the laboratory;

- Current sample storage procedures and storage areas are consistent with industry standards.

12 DATA VERIFICATION

12.1 Internal Data Verification

12.1.1 Data Verification at Newcrest 2019 Acquisition

Over 90% of Imperial assay data were electronically loaded into acQuire from the original laboratory assay files. Historical assay data prior to Imperial's Project interest were imported and validated as part of verification in support of technical reports prepared under NI 43-101.

12.1.2 Database

Data were manually checked for errors and gaps prior to database upload, and where issues arose, these were corrected. If the data related to laboratory analysis, any issues were recorded in an Issues Register and actioned according to internal Newcrest Corporate Standards. After the data were checked, they were imported into the Newcrest acQuire database and internal validation reports were used to ensure there were no conflicting (e.g., overlapping intervals or assays recorded beyond the end of hole) entries. Data validation was undertaken by the Red Chris site team under the supervision of the Regional Exploration Manager.

Regular reviews of data quality are conducted by site and corporate teams prior to resource estimation, in addition to external reviews.

12.1.3 QA/QC

Data verification of the QA/QC data is discussed in Section 11.6.

Newcrest personnel conduct regular laboratory audits. Physical inspections were conducted of the Bureau Veritas Vancouver laboratory in 2017, 2018 and 2019. Due to restrictions relating to the COVID-19 pandemic, the 2020 audit was a virtual laboratory audit.

12.2 Data Verification by Qualified Person

The QP visited the site most recently in April 2019 (refer to Section 2.4). Observations made during the visit, in conjunction with discussions with site-based technical staff also support the geological interpretations, and analytical and database quality.

The QP's role as the Group Manager Resources includes review of the estimation processes in place for Mineral Resource and Mineral Reserve estimation, mine planning, and the control procedures in place to ensure the process is being executed as intended.

12.3 Resources and Reserves Steering Committee

Newcrest has implemented a steering committee, termed the Resources & Reserves Steering Committee, to ensure appropriate governance of development and

management of resource and reserve estimates, and the public release of those estimates. This is achieved by ensuring regular Resources & Reserves Steering Committee review meetings, internal competent reviews, and independent external competent reviews.

In particular, the Resources & Reserves Steering Committee is responsible for monitoring performance of Mineral Resource and Mineral Reserve models, ensuring governance over changes to estimation, and reporting of resources and reserves including critical input parameters of cost base assumptions, metallurgical recovery algorithms and mining dilution. The Resources & Reserves Steering Committee also monitors reconciliation of extracted metal to the resources and reserves and provides governance to resolving reconciliation variance. The committee ensures that independent external reviews of Mineral Resources and Mineral Reserve estimates for each deposit are conducted at a minimum of every three years or more frequently when a material change has occurred.

The Resources & Reserves Steering Committee has permanent committee members that represent the following areas: operations, resource management, commercial, mining, and metallurgy.

12.4 External Data Verification

A number of data verification programs were conducted in support of technical reports on the Project, from 2004–2021. These indicated, that at the time each database iteration was reviewed, there were no significant issues that would have precluded Mineral Resource estimation or imposed confidence classification limits on certain data support.

12.5 QP Comments on “Item 12: Data Verification”

The process of data verification for the Red Chris Operations was performed by Newcrest personnel and external consultancies contracted by Newcrest.

The QP reviewed the reports and is of the opinion that the data verification programs indicate that the data stored in the project database accurately reflect original sources and are adequate to support geological interpretations and Mineral Resource estimation. The data support Mineral Reserve estimation and mine planning for the Red Chris deposit.

The QP visited the site most recently in April 2019 (refer to Section 2.4). Observations made during the visit, in conjunction with discussions with site-based technical staff also support the geological interpretations, and analytical and database quality.

The QP’s role as the Group Manager Resources includes review of the estimation processes in place for Mineral Resource and Mineral Reserve estimation, mine planning, and the control procedures in place to ensure the process is being executed as intended.

13 MINERAL PROCESSING AND METALLURGICAL TESTING

13.1 Introduction

The Red Chris process plant was commissioned on open pit ore in 2015. Testwork on the open pit ores was primarily completed at G&T Metallurgical Services in Kamloops, BC during 2004.

Testwork since 2019 was completed by Base Met Laboratories in Kamloops, BC, ALS Laboratories in Burnaby, BC, and Amtel in London, ON.

13.2 Testwork Programs

Table 13-1 summarizes the various testwork programs that are pertinent to the open pit and underground block cave and their respective life-of-mine (LOM) plans.

13.3 Open Pit Testwork

The results of the G&T 2004 metallurgical programs were used as the basis for the design and consumption parameters for the Red Chris concentrator. The G&T 2004 programs confirmed that the mill flowsheet for Red Chris would use conventional processing techniques for a porphyry copper–gold flotation plant.

Metallurgical testwork was performed in support of the original plant design. Subsequent testwork focused on the material planned to be mined as part of block cave operations.

The metallurgical testwork supporting the current process plant design included mineralogy, grind size tests, bench tests, locked cycle flotation tests (pulp density, pH, reagent dosage, flotation residence time and grind size effect), gravity concentration testwork, ball mill and rod mill grinding work index tests, evaluation of metallurgical variation between the Main and East zones, and a pilot plant program. The testwork indicated that a conventional process plant design could be used.

A primary grind of 150 μm K_{80} was determined as optimum for the Red Chris ore. At this feed sizing, 50% of the chalcopyrite and bornite particles were liberated, together with 90% pyrite liberation and 95% non-sulphide gangue minerals.

Red Chris ore required an approximate 15% mass pull resulting in a rougher concentrate grade of 3% Cu. The regrind circuit power was specified based on a design weight recovery of 15%.

Gravity concentration testwork resulted in minimal gold recovery, no additional work was performed, and the inclusion of a gravity stage was not recommended in the flowsheet.

An average 16.1 kW-hrs/t ball mill work index was used to calculate power requirements for mill sizing at 30,000 t/d.

Table 13-1: Testwork Program Dates and Status

Program	Sample Source	Testwork and Conditions	Status	Date
Block Cave PFS Design & Optimization (BL0653)	5 vertical horizon composites collected from 2019 drill core.	Comminution tests, flotation optimization tests, open circuit cleaner at standard and optimized conditions; locked cycle tests.	Complete	2020–2021
Block Cave ODK - 1a (BL0535)	33 variability samples in Lower East Zone within block cave footprint.	Comminution tests, open circuit cleaner testwork at standard open pit conditions.	Complete	2020
Block Cave ODK – 1b (BL0663)	Repeated testwork using the same samples as in Block Cave ODK - 1a	Repeated open circuit cleaner tests at optimized conditions	Complete	2021
Block Cave ODK – 2 (BL0663)	Additional (TBC) variability samples from 2020 block cave drilling.	Open circuit cleaner tests at optimized conditions.	Sample yet to be collected.	2021
Open Pit ODK (BL0511 and BL0662)	70 variability samples mostly from drill core covering Main, Mid and East Zone open pit area.	Open circuit cleaner testwork at standard open pit conditions.	Mostly complete, mineralogy yet to be completed.	2020–2021 (On-going)
Block Cave HydroFloat (KM6275)	Combined 5 vertical Horizon composites collected from 2019 drill core.	Scoping HydroFloat Tests	Complete	2021
Block Cave HydroFloat (BL0653)	Combined 5 vertical Horizon composites collected from 2019 drill core.	Scoping HydroFloat Tests	Complete	2020–2021
Block Cave Cleaner Modelling (SGS 17441-01)	Mineral Flotation Tests (MFT) on block cave variability composites.	Cleaner circuit modelling.	Complete	2021
BL0377	East Zone, three samples, two of which are in the block cave area and one in open pit area.	Locked cycle and cleaner testwork similar conditions.	Complete	2018
KM1428	East and Main Zone drill core ~ 2003. Covering open pit area	Open circuit and locked cycle tests at a range of conditions similar to plant and more recent testwork below.	Complete	2003–2004

Note: ODK = ore deposit knowledge. The BL0377, BL0511, BL0535, BL0653, BL0662 and BL0663 programs were completed at Base Met Laboratories in Kamloops, BC. The KM6275 program was completed at ALS Laboratories in Kamloops, BC. The SGS 17441 program was completed at SGS Laboratories in Burnaby, BC.

The copper recovery to concentrate forecast ranged from 85–90% while gold recoveries varied between 45–65%. Gold recovery in both zones was dependent on the head grades and pyrite content, and was higher in East zone.

Recovery predictions made prior to Newcrest's Project interest were significantly higher than seen in actuality from the plant. This has primarily been attributed to the following causes:

- The grind size has been somewhat coarser than the original design target of 80% passing 150 µm;
- The original design rougher flotation residence time was not sufficient to support high rougher stage recoveries;
- There were process constraints in the cleaning circuit that have been subsequently addressed by Newcrest through the installation of an additional flotation column;
- Faulted open pit ore has caused periodic metallurgical issues in the plant.

Newcrest performed two orebody knowledge programs (BL0511 and BL0662) to more reliably predict the performance of the remaining ore in the open pit. These were based on 66 samples from the mineralization captured within the open pit resource shell. Thirteen samples were identified as potentially fault-impacted.

Samples identified as fault impacted were assessed for metallurgical performance. A copper recovery loss of up to 25–30% copper was indicated for the extremely fault-impacted samples. Fault material was seen to have a large impact on copper recovery in the orebody knowledge testwork programs. In practice, the process of mining significantly dilutes the fault material and recovery decreases in the process plant in the order of 2–4% recovery were observed when processing open pit ores.

13.4 Underground Block Cave Testwork

This subsection summarizes the testwork completed in support of the 2021 PFS.

13.4.1 Sample Selection

A total of 34 samples from the mineralization captured within the underground resource shell were used in the underground metallurgical testwork. One of these samples was later determined to be waste material and was excluded from further evaluation. Five samples were found to later be outside the confines of the underground model (Figure 13-1). Two samples were identified as potentially fault-impacted.

The initial samples had a minimum copper grade requirement of 0.25%. The samples selected were representative of the material expected to be mined using underground mining methods, both spatially and with respect to the mineralization grade.

Additional composites representing underground material were collected from 40 m long core samples, composited into five composites (the 'Horizon' composites) was centred at key spatial levels (RL) as shown in Figure 13-2.

Figure 13-1: Cross-Section Showing Sample Locations

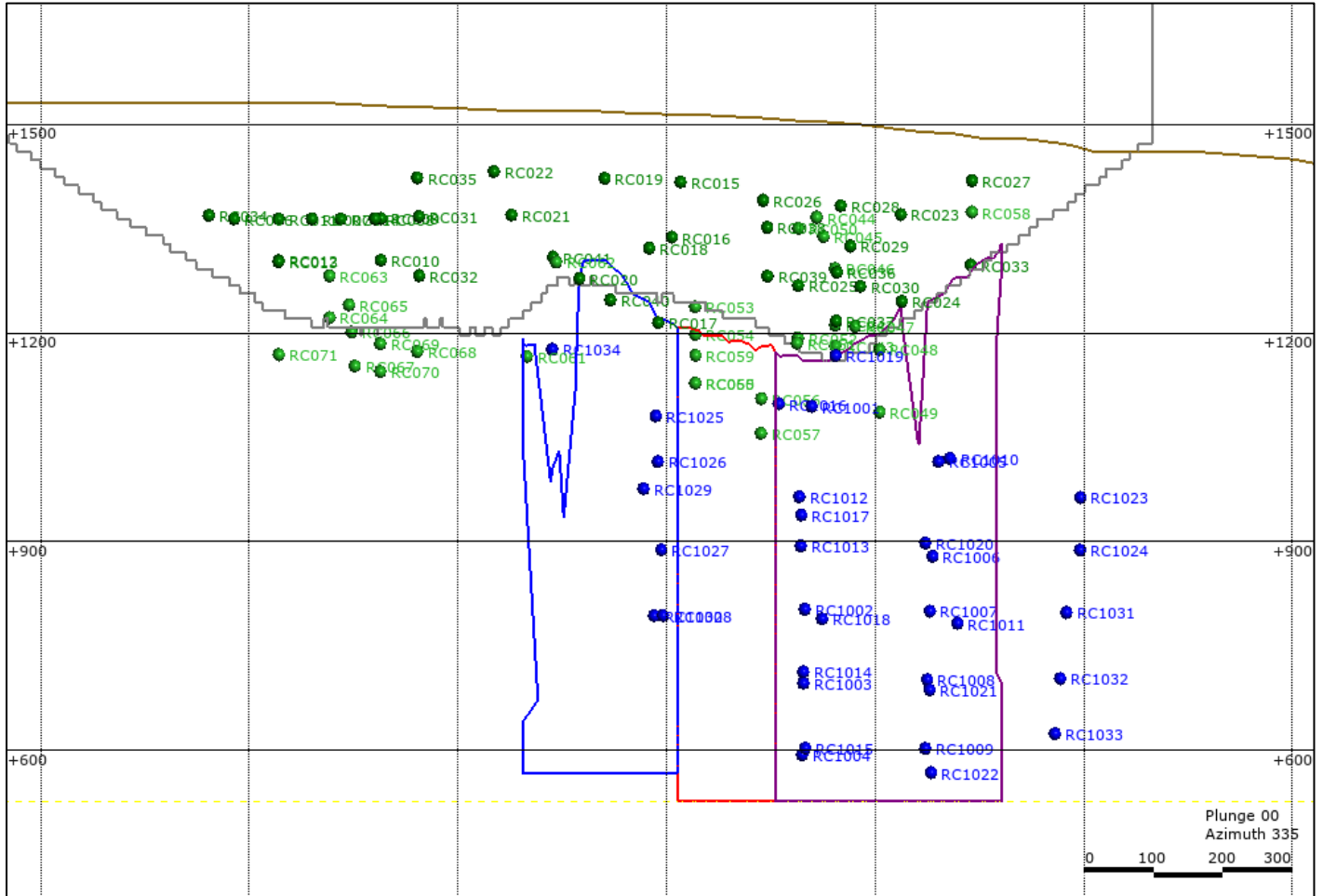

Note: Figure prepared by Newcrest, 2021. Blue samples represent the underground component, green samples represent the open pit component.

Figure 13-2: Location Map, Horizon Composite Samples

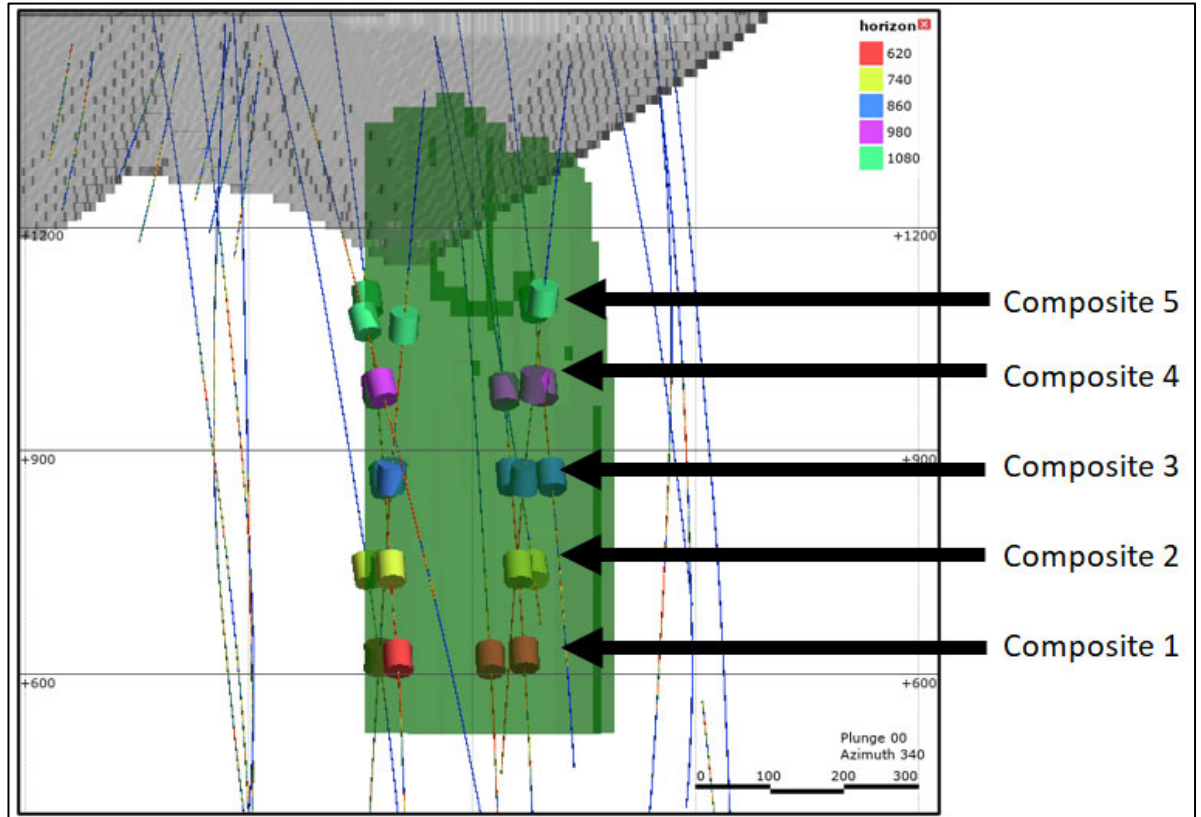

Note: Figure prepared by Newcrest, 2021.

Each RL slice (or horizon) was representative of a time period in the early mine life, with Composite 1 representing the first two years of production.

13.4.2 Testwork Conducted

The testwork programs informing the 2021 PFS process design included:

- Mineralogy: gold diagnostic analysis;
- Gold diagnostic leach tests: help infer gold deportment;
- Comminution tests: hardness (hardness index testing (HIT); JK breakage parameters (Axb); semi-autogenous grind (SAG) mill comminution (SMC)), SAG mill specific energy, Bond indices (drop weight index (DWi), Bond ball mill work index (BWi)), abrasion index (Ai), specific gravity;
- Gravity recovery: gravity recoverable gold;
- Flotation optimization tests: two-stage flotation;
- Open circuit cleaner at standard and optimized conditions;

- Rougher flotation: grind recovery series, size by size recovery, kinetics, reagent optimization;
- Re grind: Levin tests, Bond indices;
- Cleaner flotation: batch cleaner tests, cleaner dilution tests;
- Locked cycle tests;
- Concentrate dewatering: concentrate settling, concentrate filtration;
- HydroFloat tests;
- Material classification for environmental purposes.

13.4.3 Mineralogy

Mineralogical data were collected for underground samples using the internal Newcrest mineral liberation analyzer (MLA) to provide scanning electron microscopy information, and quantitative X-ray diffraction (XRD) and optical microscopy performed by the Amtel laboratory, located in Ontario, Canada, to provide information on gold deportment.

Samples from the area to be mined by underground methods were found through MLA analysis to have significantly lower quartz and pyrite contents (0.5% average pyrite content) versus samples from the open pit area (5.6% pyrite on average). There was a subtle shift in mineralogy from predominantly intermediate argillic and phyllic altered material higher in the system (higher kaolinite, quartz, and pyrite) to predominantly potassic alteration at depth. Copper distribution was almost solely contained within chalcopyrite in the open pit environment (average 92.7% of the copper distribution), and the average bornite content was 6%. In the proposed underground area, the bornite content averaged 21.4%, and the chalcopyrite content was about 77.3%. The S:Cu ratio was, on average, significantly higher and more variable for open pit ores than for underground ores.

Copper sulphide grain size varied for the underground mineralization from a P_{80} between 45–150 μm . The open pit samples had a similar grain size, with the P_{80} range between 50–120 μm . Pyrite was coarser-grained than the copper sulphides, but still exhibited similar grain size ranges in the open pit (P_{80} of 100–300 μm) and underground (P_{80} of 90–400 μm) areas.

The Amtel work indicated that the gold was primarily in the form of gold–silver–mercury alloys. At a grind size of approximately 150 μm , free gold grains contributed 30–58% of the gold balance, and typically contributed about a third of the grade. Most of this free gold reported to the <7 μm size fraction.

Gold carried by free sulphides accounted for 16–26% of the gold balance, and gold carried by sulphide rock binaries accounted for 13–49% of the grade. The proportion of gold carried by gangue ranged from 4–14%, equating to between 0.048–0.096 g/t Au. Gold mineralization was always predominantly associated with copper sulphide mineralization rather than pyrite. All samples contained some gold mineralization associated with gangue particles. The size distribution of gold inclusions and

attachments was similar in all samples; with attached gold particles approximately 8 μm (range from 6–12 μm) in size and inclusions averaging 3 μm .

Samples sourced from a plant survey in August 2019 were sent to Amtel for gold department analysis and to determine the mineralogy and potential cause of penalty elements (antimony and mercury) reporting to the concentrate.

The concentrate contained:

- 63.3 wt% copper minerals: 63% of which was chalcopyrite, the other 0.3% was tetrahedrite;
- 21.8 wt% pyrite: 75% of the pyrite reporting to the concentrate was liberated, the rest was in binaries with chalcopyrite;
- 14.7 wt% gangue particles: primarily micas and clay with lesser carbonates or non-layered silicates (quartz, feldspar).

The combined pyrite and gangue particles carried 6% of the gold grade and 4% of the copper, with gold mainly associated with pyrite.

Antimony in the concentrate was dominantly (98%) in the form of tetrahedrite, which was primarily liberated or associated with chalcopyrite. Antimony in solid solution was a minor component that was nearly equally carried by pyrite and chalcopyrite.

Mercury in the concentrate was dominantly (93%) in the form of coloradoite (HgTe) and cinnabar. The final 7% of the mercury in concentrate was as solid solution in pyrite.

The nature of these penalty elements indicates that unless the deportment of antimony and mercury changes significantly in the underground environment, these elements could be potentially problematic in future concentrates.

13.4.4 Comminution

A total of 32 samples were selected for SMC, HIT, and Bond index testing.

Comminution results are summarized in Table 13-2 for the 2021 PFS design, with the original design parameters for open pit ores used to size the existing mill provided for comparison.

Among the 32 samples, some samples had both SMC and HIT test results, others only had HIT test results. For those samples that did not have the SMC test results, the HIT test results were used to give approximations of the ore competence. The SMC test Axb parameter and HIT Axb parameter (or converted DWi parameter) were found to be reasonably correlated, particularly for Axb range of 30 to 50 (medium to hard in terms of resistance to impact breakage).

The data set showed a moderate variability for the DWi parameter as measured by the coefficient of variation (20%), suggesting that the variability in the dataset was less than optimum for good characterization of the deposit. For the Bond ball mill tests, the data set showed a low coefficient of variation (8.4%), suggesting acceptable variability in the dataset to be treated as a single ore type.

Table 13-2: Comminution Results

Description	Unit	Original Design	2021 PFS Design	2021 PFS Nominal
JK Axb parameter	—	50 (40 to -61)	32.3	35.2
SMC DWi parameter	kWh/m ³	5.5	8.6	7.8
SMC Mia parameter	kWh/t	16.7	23.0	21.4
SMC Mib parameter	kWh/t	21.1	23.0	22.2
SMC Mic parameter	kWh/t	6.1	9.3	8.4
Bond ball work index, BWi	kWh/t	16 (13.5–20)	19.6	18.9
Abrasion index	g	N/A	0.154	0.154

The underground ores are substantially harder (about 30%) than the open pit ores. The 75th percentile database values in terms of ore hardness were selected for comminution circuit design.

13.4.5 Recovery Circuit

The recovery circuit at the Red Chris process plant currently consists of a sequential flotation circuit to produce a saleable gold-bearing copper concentrate.

A two-stage cleaner flotation flowsheet that replicated the current Red Chris Operations flowsheet was used to test the underground mineralization with the intent of optimizing the flotation operating conditions (Figure 13-3). Test results showed similar copper recoveries and deportment between open pit and underground samples, with a slight improvement for the underground ores due to higher grades, which will result in higher copper grades in the concentrate.

This contrasted with gold where the recoveries were higher for underground versus open pit with underground showing different deportment characteristics in the different flotation streams.

13.4.5.1 Rougher Flotation

The rougher flotation circuit design investigated residence time/chemistry, mass pull, and primary grind size. From these data, linear predictions of grind dependence on recovery were estimated for use in options analyses.

The recovery benefit of increasing the retention from 8–12 mins (laboratory) averaged 2.3% for copper and 3.3% for gold at 150 µm with a similar recovery benefit at 200 µm.

The 2021 PFS design assumed a 12 minute target laboratory retention time. A scale-up factor of 2.5 was used when scaling up laboratory retention times to conventional tank cells, which is consistent with industry standards for copper rougher flotation. This equated to a 30 minute retention time for rougher flotation capacity using conventional tank cells. The 2021 PFS used a target installed retention time of 30 minutes when using conventional tank cells.

Figure 13-3: Two-Stage Cleaner Test Flowsheet

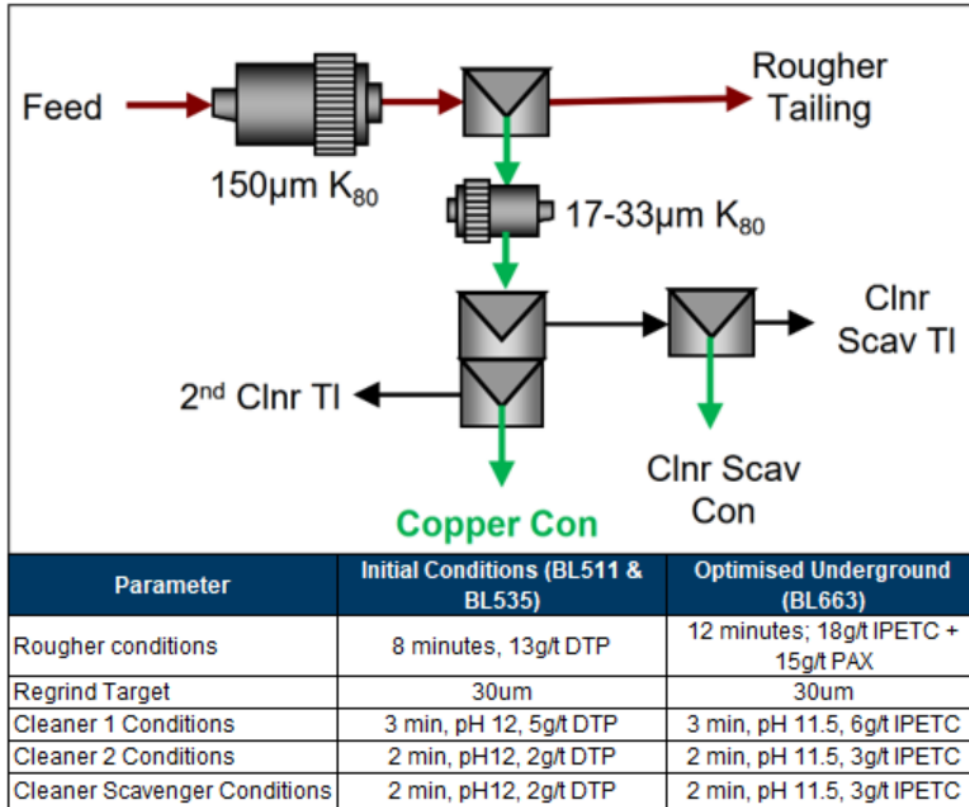

Note: Figure prepared by Base Met, 2021.

StackCells were selected as the preferred flotation technology for incremental rougher capacity because pilot plant testwork indicated that the flotation kinetics of the StackCell was four times quicker than a conventional tank cell (see additional discussion on the StackCells in Section 17).

Primary grind size versus rougher recovery was investigated for copper and gold; using:

- Grind series of primary grind versus rougher flotation recovery: 100 µm, 125 µm, 150 µm, 175 µm, and 200 µm. Direct test results at the varying primary grind sizes;
- Size-by-size recovery and rougher Bazin analysis. An indirect interpretation of the metal department in the various size fractions and resulting recovery in that specific size fraction.

The optimized testwork dataset showed that mass pull would not exceed the 2021 PFS design target, and that copper and rougher recoveries would not be limited by mass pull. Considering the testwork results and examining the variability, a design value of a 15% mass pull was supported for the 2021 PFS.

13.4.5.2 Regrind

The uncorrected specific energy requirement using ball mills for each underground composite was interpolated to achieve a product P_{80} of 30 μm from a feed F_{80} of 120 μm . The mean value was 26.3 kWh/t and the 70th percentile value was 27.7 kWh/t.

Levin standard tests were performed on the rougher concentrates from the plant regrind survey and laboratory flotation testing; the plant samples showed a higher specific energy requirement than all five underground composites. The Levin test results were corrected by applying the standard Bond correction factors together with operational efficiency factors.

Plant operating data from the existing regrind circuit were analyzed by comparing total specific energy (sum of regrind ball mill and Vertimills) to the achieved grind size. The unmeasured recirculating load of the cleaner scavenger concentrate was estimated from survey data at 5% of the fresh cleaner feed flowrate.

From historical data, approximately 14 kWh/t of energy will be required to achieve the target grind size of 30 μm .

13.4.5.3 Cleaner Flotation

The cleaner flotation circuit testwork investigated the effects of pH and regrind size using the flowsheet in Figure 13-4.

With regrinding it was possible to achieve the 2021 PFS design target for all composites except one, where it is interpreted that the composite had increased levels of pyrite in comparison to the other composites tested.

The current design philosophy with a Jameson Cell in cleaner scalper duty was used for the 2021 PFS. The flowsheet will operate the 1st cleaner column and 3rd cleaner column in series. The 2nd cleaner column will be retained for standby duty.

13.4.6 Dewatering

A number of static settling tests were carried out on open pit final concentrates from the plant, and the underground final concentrates from the locked cycle tests. This testwork showed that the underground composites exhibited similar settling characteristics as the plant concentrate.

Additional settling tests were performed including: repeat tests to understand the testing reproducibility, and 1 L cylinder tests at varying feed solid content to understand the impact of the feed solid content on settling rate and final underflow density.

A number of filtration tests were carried out on the open pit final concentrates from the plant, and the underground final concentrates from the locked cycle tests. Additional comparative filtration tests were performed on laboratory-produced open pit concentrate to develop an understanding of the variability.

The concentrate filtration testwork was completed with feed solids density of 50 w/w%. A unit area of 200 kg/hr/m² was used. The cycle time and t/cycle for the horizontal press filters will be 15 to 20 minutes per cycle and 11.5 to 12.0 dry t/cycle.

Figure 13-4: Locked Cycle Testwork Flowsheet

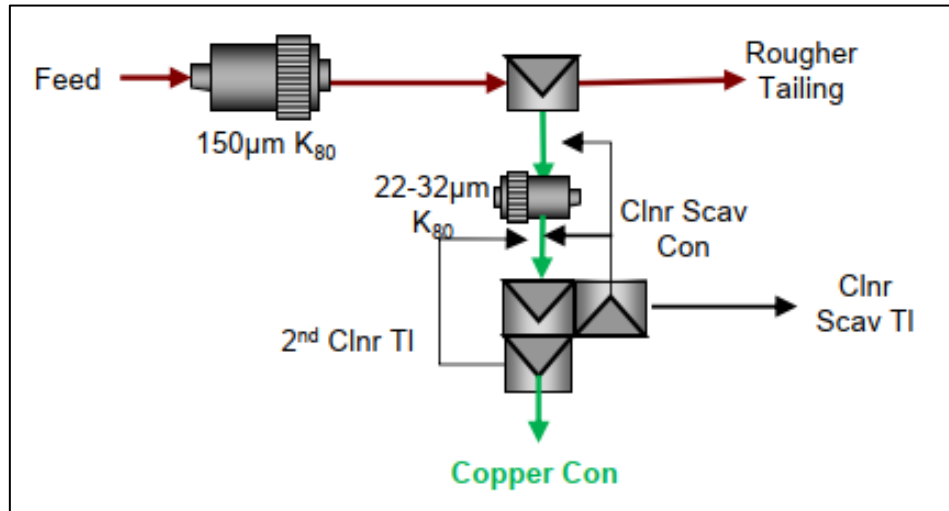

Note: Figure prepared by Base Met Laboratories, 2021.

13.4.7 Environmental Considerations Regarding Tailings from Process Plant

Tailings from the process plant are segregated to meet environmental criteria for metal leaching-acid rock drainage (ML/ARD). The main goal is to produce a non-acid generating (NAG) tailings stream from copper rougher tailings. When pyrite in ore is elevated, an additional pyrite scavenging step is required to achieve designed NAG tailings characteristics. Cleaner-scavenger tailings, combined with pyrite scavenger concentrate when this circuit is operated, form the potentially acid-generating (PAG) tailings stream.

Neutralizing potential ratio (NPR) is determined for tailings streams, defined as:

- The ratio of the acid potential (AP), determined by the sulphur content of the material to the neutralizing potential (NP), based on the amount of carbonates present.

Tailings are considered to be NAG when $NPR > 2$. The anticipated NPR for tailings generated from underground mineralization and open pit mineralization were compared.

In-situ neutralizing potential of material within the long-term planning model was based on the calcium and magnesium grades of the samples (carbon was not routinely measured during Imperial's drilling programs), with the AP determined from the sulphur grade.

The mean NPR for the underground samples was 4.87 (median 3.97), which is significantly higher than the results seen in the open pit environment (average 2.07; median 1.27). Only 12% of the underground samples were classified as PAG, whereas 65% of the open pit samples were classified as PAG. This variation was driven by the reduced amount of pyrite present in the underground environment. The carbonate contents were similar between the open pit and underground.

The final storage location tailings was determined by NPR, following conservative verification sampling. The TIA provides a sub-aqueous environment for the storage of PAG material, which is managed by centralized subaqueous deposition in the Tailings Impoundment, impounded at the centre of the valley by NAG sand beaches where NAG tailings are exposed to the atmosphere and serve as the primary material for construction of the TIA dams and beaches. Data analysis of the open pit and underground sulphur to carbon ratio data using histograms indicated that sufficient NAG sand can be produced for LOM purposes.

13.5 Recovery Forecasts

13.5.1 Open Pit

Recovery for copper and gold are defined by four metallurgical domains with recovery formulas being a function of the gold and copper grade in combination with the mill production rate. The LOM copper recovery was estimated to be 79% and gold recovery was estimated to be 51% within the Mineral Reserves amenable to open pit mining.

The equation used to forecast the copper recovery is:

- $\text{Cu recovery} = (9.7 * \text{Cu Head Grade} * 100 + 80.224) / 100 * 0.945 - 0.39 / 100$

Where the copper head grade format is percent, for example, 0.40%.

The equation used to forecast the gold recovery is:

- $(1.859 + 0.124 * \text{LN}(\text{Au head grade}) - 0.169 * \text{LN}(1403)) * 0.95$

Where the gold head grade is in g/t. LN = natural log.

These regression equations are informed by plant recovery performance data.

13.5.2 Underground

Recoveries for copper are a function of the copper grades in combination with the mill production rate. In the case of gold recoveries, the gold to sulphur ratio is the primary factor impacting plant recoveries.

13.5.2.1 Copper

A linear model with head grade was fitted to the copper recovery data at a grind size P_{80} of 150 μm ; a maximum of 92% copper recovery was applied to the equation as a logical constraint:

- $\text{Copper recovery (\%)} \sim 76.5 + 11.9 * \text{Cu}$ (maximum copper recovery of 92%)

Where: Cu = copper head grade in percent.

This recovery equation gives a LOM average recovery range of 81–86%.

13.5.2.2 Gold

The block cave samples show significantly higher gold recovery than open pit material at equivalent head grades as well as greater variance. A lower pyrite content in the ore can

reduce the quantity of refractory gold and, therefore, an improvement in flotation recovery of gold. This was confirmed in the diagnostic leach results, which showed significantly higher gravity and cyanide soluble gold deportment for the samples from the block cave. The diagnostic leach results (gravity plus cyanide soluble components) show a general trend directly proportional to the overall gold recovery, and the same diagnostic leach categories are strongly related to the ratio of gold to sulphur in the sample head grades

The predictive equation for gold recovery of the block cave ore at a grind size P_{80} of 150 μm is:

- Gold recovery (%) $\approx 72.5 + 9.3 \cdot \text{LN}(\text{Au/S})$

Where: Au = head grade in g/t, and S = sulphur head grade in percent. LN = natural log.

This recovery equation gives a LOM average recovery range of 60–75%.

13.5.2.3 Silver

The silver value contribution is low; however, it is still a significant payable value if present in concentrate at over 30 g/t. Silver recovery in the underground samples was found to be significantly greater than in open pit samples tested to date.

The average silver recovery in the testwork was 63% with P25 and P75 values of 57% and 71%, respectively.

13.6 Metallurgical Variability

Samples selected for metallurgical testing were representative of the various styles of mineralization within the different deposit areas. Samples were selected from a range of locations within the deposit zones. Sufficient samples were taken and tests were performed using sufficient sample mass for the respective tests undertaken.

Additional samples have been collected for confirmatory testwork to support future more detailed studies.

13.7 Concentrate Quality

The underground variability program results indicated that, on average, concentrate grades in second cleaner concentrate in laboratory tests exceeded the current operational target of 23% Cu. This is mainly attributed to two characteristics of the underground test samples:

- The presence of bornite (an enriched copper mineral) in addition to chalcopyrite (copper deportment in the open pit ore is dominantly in chalcopyrite);
- Lower pyrite content in underground ores tested compared with open pit ores, leading to easier separation of copper sulphides from pyrite.

A minimum and maximum concentrate grade of 23% and 28%, respectively, were applied to any forecast concentrate grades. There was sufficient evidence that the plant can achieve a minimum of 23% Cu concentrate grade on much lower Cu:S ratios from open pit material by manipulating the pH in the cleaners and adjusting collector additions.

The maximum of 28% Cu is considered to be a conservative view on the upper end of the scale. It is possible that the favourable mineralogy of underground ores could result in still higher concentrate grades from time to time.

The equation is:

- Copper grade in concentrate (% Cu) $\approx 13.2 + 21.8 * \text{Cu:S in feed}$ (minimum 23%, maximum, 28%)

Where: Cu = copper head grade in percent, and S = sulphur head grade in percent.

13.8 Deleterious Elements

Deleterious elements potentially include mercury and antimony.

The current limit for mercury penalty payment is 40 ppm in concentrate. Approximately one-third of the mercury in the plant feed is highly floatable and will be recovered to the copper concentrate. A predictive formula for the mercury in copper concentrate was developed:

- Hg in final concentrate (ppm Hg) $\approx 0.332 * \text{Hg in feed} * \text{copper concentrate grade/copper feed grade}$

Indications are that most underground ores are not expected to produce concentrates that trigger penalty mercury levels. These observations are based on a combination of laboratory testwork results as well as predictions from underground mine plan mercury head grades.

Antimony has generally been observed in open pit and underground concentrates at levels below those that would trigger a penalty (0.01%).

13.9 QP Comments on “Item 13: Mineral Processing and Metallurgical Testwork”

The QP notes:

- The testwork completed is adequate to ensure an appropriate representation of metallurgical characterisation and the derivation of corresponding metallurgical recovery factors for the open pit mineralization;
- The 2021 PFS metallurgical testwork program confirmed that a flowsheet incorporating crushing, grinding, flotation, and concentrate dewatering was suitable for the planned block cave;
- Additional characterization of the mineralization at depth is planned to provide greater spatial coverage of the proposed block cave;
- Underground ore was determined to be significantly harder than open pit ore, therefore, requiring increased power input per tonne of ore treated for a given grind size. There is a general increase in hardness with depth, implying that throughput rates and grind size will be impacted positively over the progression of each macroblock within the block cave design (see section 15.3.1 for definition of macroblocks);

- Copper and gold head grades were confirmed to be significantly higher than open pit material, especially for macroblock 1. Underground ore was also shown to have significantly lower pyrite content than open pit ore, which may help moderate water quality risks associated with potential acid generation in the TIA;
- The flowsheet development testwork confirmed that grinding and flotation are suitable unit operations for Red Chris block cave ore and can allow recoveries of approximately 81–86% for copper and 60–75% for gold;
- Marketable concentrates can be produced from underground ore, with some ore zones enriched in secondary copper minerals such as bornite producing elevated concentrate grades;
- Some samples showed elevated mercury levels in the concentrate, but these were not high enough to cause any significant marketing concerns;
- Additional variability testwork was performed subsequent to the completion of the 2021 PFS. Preliminary results have been received, and are in the process of being interpreted. The provisional reviews suggest that there is no significant difference between these samples and the results of the testwork that the 2021 PFS was based upon.

14 MINERAL RESOURCE ESTIMATES

14.1 Introduction

The close-out date for the drill database supporting the estimate is 8 February, 2021.

14.2 Modelling Approach

Due to the mixed nature of the data from different companies over time, the lithology interpretation of the historical data is heavily reliant on the lithology logging and the associated assay data. The key lithologies are the porphyry units (P1, P2, P3), the Stuhini Group volcanic and sedimentary rocks, the Bowser Lake Group, and the mafic dykes. The mafic dykes are not modelled separately at the block model scale, as they are narrow and discontinuous. The other lithologies are modelled.

Five lithology domains were constructed and used in estimation:

- Red Stock porphyry phases P1+P3;
- Red Stock porphyry phase P2;
- Bowser Lake Group;
- Stuhini volcanic;
- Stuhini sediment.

A geologically-based alteration model was built for the East Zone using Leapfrog software, based on drill hole logging data, photo relogs, assays, and Corescan data. The combined implicit and sectional model consists of six alteration domains:

- Sodic;
- Propylitic;
- Phyllic;
- Intermediate argillic;
- Potassic;
- Calc–potassic.

A geologically-based sulphide model was built using Leapfrog software based on drill hole data that was primarily collected by Newcrest. Five domains were constructed:

- Bornite–chalcopyrite domain;
- Chalcopyrite–bornite domain;
- Chalcopyrite–pyrite domain;
- Pyrite–chalcopyrite domain;
- Pyrite domain.

Due to the diffusive nature of the porphyry, the copper and gold mineralisation are primarily within the different porphyry phases, rather than within the major alteration zones; hence, the lithology domains were used in estimation.

14.3 Exploratory Data Analysis

Univariate statistics and scatter plots were run on the different lithology domains for the Main, East and Gully zones. A moderate correlation was apparent between iron and sulphur, and between calcium and magnesium.

Contact plots were constructed to determine boundary constraints between domains. A soft boundary was used between the P1+P3 and P2 phases within the Red Stock intrusion. Hard contacts were used between all other domains.

Histogram plots were constructed in support of grade capping evaluation. Both copper and gold had positively skewed distributions. Density data approximated a normal distribution.

Diffusion examinations were run to determine whether a Gaussian-based or non-parametric multiple-indicator kriged estimation method best applied to Red Chris. Checks were done for gold, copper, iron, sulphur, calcium and magnesium. These indicated a Gaussian-based interpolation method was the preferred estimation method.

Gaussian (normal scores) transformations were used on declustered weights. The transform and back-transform was accomplished using Hermite polynomials.

14.4 Density (Specific Gravity) Assignment

Available bulk density data consisted of 6,404 determinations in the Red Stock, averaging 2.78, 742 in the volcanic domain, averaging 2.79, 37 in the sediment domain, averaging 2.80, and 16 in the Bowser domain, averaging 2.58.

The bulk density data were interpolated using an inverse distance weighting to the third power (ID3) interpolation.

14.5 Grade Capping/Outlier Restrictions

No grade caps were imposed on the gold or copper data.

However, to make sure that the potential smearing of outlier grades was reduced, a grade and distance restriction was applied to selected variables during the estimation process (Table 14-1). The selected restriction was an iterative process, based on inspection of histograms and log probability plots, to ensure a reasonable agreement between the value estimated, and the declustered composite value.

14.6 Composites

Sampling was typically on 2.5 m intervals, which were composited to 12 m lengths. Any residual interval was equally distributed into the composite intervals. The 12 m composite length was considered appropriate for the mineralization style and matches the vertical dimension (RL) of the selective mining unit.

Table 14-1: Outlier Restrictions

Area	Variable	Domain	Grade Restriction	Distance Restriction (m)
Main and East Zones	Cu	P1+P3	0.27%	80
	Au	P1+P3	0.34 g/t	80
	Ag	P1+P3	16 g/t	100
	Ag	P2	20 g/t	100
	As	P1+P3	290 ppm	100
	As	P2	450 ppm	100
	Sb	P1+P3	250 ppm	100
	Sb	P2	270 ppm	100
	Hg	P1+P3	9.6 ppm	100
	Hg	P2	15 ppm	100
Gully/Redstock	Cu	P1+P3	0.21%	20
	Au	P1+P3	0.32 g/t	20
	Au	P2	1.1 g/t	200
	Ag	P1+P3	8.2 g/t	100
	Ag	P2	6.9 g/t	100
	As	P1+P3	105 ppm	100
	As	P2	86 ppm	100
	Sb	P1+P3	89 ppm	100
	Sb	P2	44 ppm	100
	Hg	P1+P3	1.5 ppm	100
Hg	P2	0.96 ppm	100	

14.7 Variography

Variograms for the Red Stock domains were run on copper, gold, silver, iron, sulphur, mercury, antimony and arsenic Gaussian transformed data using Isatis software. The variogram directions were consistent with the broad domain geometry. Cross-variograms were used for calcium and magnesium as the two elements showed reasonable correlations. All Gaussian variogram and cross-variograms were modelled with a nugget and two spherical structures, then back-transformed to the raw space and re-modelled.

The experimental variogram for the Sediment, Volcanic and Bowser domains for all variables were generated using real data. Due to the strong correlation between iron–sulphur and calcium–magnesium, experimental direct and cross-variograms were generated for those elements.

14.8 Quantitative Kriging Neighbourhood Analysis

Kriging neighbourhood analysis was carried out to determine the appropriate estimation neighbourhood parameters for use in the estimation of copper and gold, consisting of:

- Establish the optimum panel size by maximising the kriging efficiency and slope of regression;
- Select the minimum and maximum sample limits by maximising slope of regression while at the same time ensuring that the percentage of negative kriging weights is manageable;
- Maximise the search ellipse ensuring that the previously-established slope of regression and negative kriging weight thresholds are not violated.

14.9 Estimation/Interpolation Methods

Estimation used a panel block size of 80 mE x 80 mN x 12 mRL and a selective mining unit block size of 20 mE x 20 mN x 12 mRL. Two block models were constructed, the first with the selective mining unit size and the second with the panel size. The domains were initially flagged in MineSight software at the selective mining unit size, then the flagged block model was imported to Isatis. All estimation was performed using Isatis software.

For the Red Stock domain, the block model used for interpolators was populated with local rotations based on the orientation of the main structures. A series of trend surfaces were used.

In the Red Stock domain, the following steps were undertaken:

- Estimate copper, gold, iron and sulphur using a three-dimensional ordinary kriging (OK) and uniform conditioning method;
- Estimate calcium and magnesium using a three-dimensional co-ordinary kriging and multivariate uniform conditioning method;
- Localize the uniform conditioning and multivariate uniform conditioning results to the selective mining unit;
- Estimate silver, arsenic, antimony, mercury and carbon to the selective mining unit.

The remaining three domains, sediment, volcanic and Bowser, were estimated using the following:

- Three-dimensional OK or co-ordinary kriging to estimate copper, gold, silver, iron, sulphur, arsenic, antimony and mercury grades;
- Carbon was estimated using OK in the sediment and volcanic domains;
- Carbon was estimated using a nearest-neighbour method in the Bowser domain.

14.10 Block Model Validation

Validation checks included examination of the block model and composites in plan and section views, domain level statistical checks, global statistical checks, comparison of the estimated value with a metal-at-risk analysis for copper and gold, comparison of the multivariate correlation of the input value and the block estimate, discrete Gaussian models, and conditional simulation models (swath plots).

All checks indicated that the estimates were acceptable. However, if the mining block selectivity is significantly smaller than 20 mE x 20 mN x 12 mRL selective mining unit assumption in the Mineral Resource estimate, then the OK estimate will be a poor predictor of the actual tonnage and grade that will be achieved at given drill hole data spacings.

14.11 Classification of Mineral Resources

The Mineral Resource is classified based on an evaluation of factors including search strategy, number of informing composites, average distance weighting of composites from blocks, kriging quality parameters, geological and grade continuity, drill spacing and drill data quality, mining method and mining selectivity, and mining rate and cut-off value.

No Measured Mineral Resources were classified for material other than stockpiles. Stockpile classifications are supported by grade control models.

An Indicated Mineral Resource was classified where the average weighted distance between informing data was <100 m, and the slope of regression was >0.7.

An Inferred Mineral Resource was classified where the block was outside the Indicated classification, the average weighted distance of the informing data was <175 m, and the slope of regression was >0.4.

A cross-section showing the blocks classified is provided in Figure 14-1.

14.12 Reasonable Prospects of Eventual Economic Extraction

Mineral Resources were estimated assuming both open pit and underground mining methods.

The Mineral Resources potentially amenable to open pit mining methods were constrained within a pit shell that assumed the following:

- Conventional truck and shovel operation;
- 11 Mt/a mining rate;
- Copper price: US\$3.40/lb;
- Gold price: US\$1,400/oz;
- Exchange rate: C\$:US\$ of 0.75;

Figure 14-1: Example Cross-Section Showing Block Classification (Easting 45680)

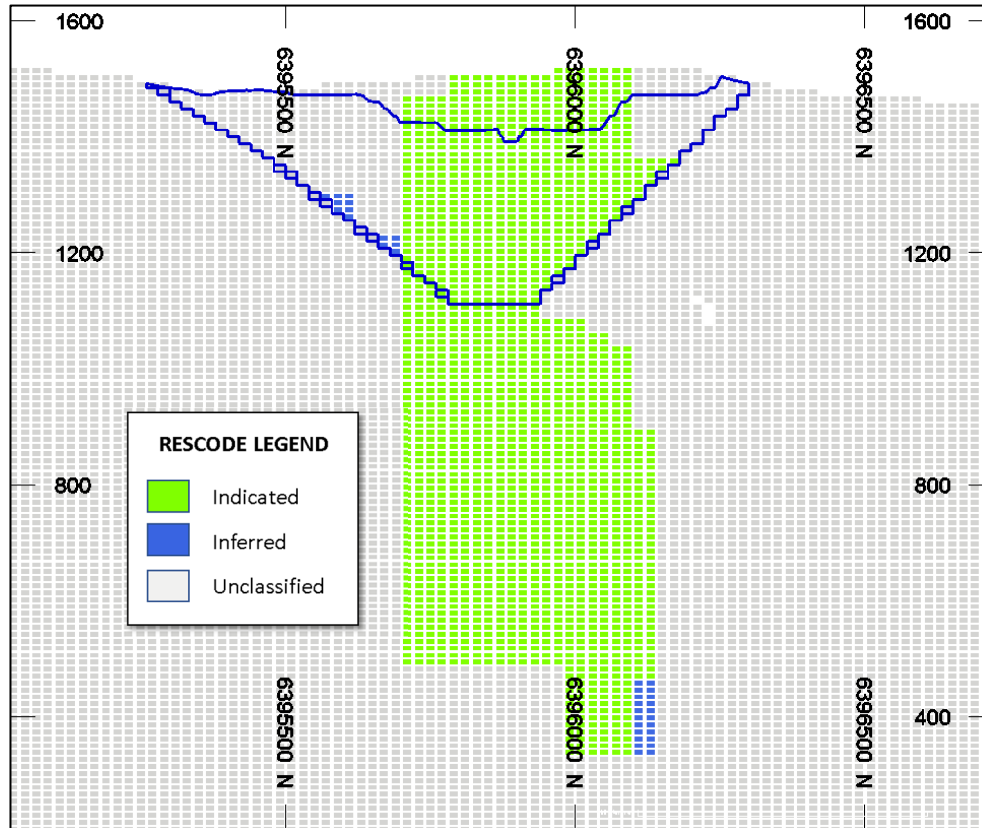

Note: Figure prepared by Newcrest, 2021. Section looks west

- Unit cost assumptions of C\$2.27/t mining, C\$0.15/t stockpile rehandle, C\$7.72/t processing, C\$4.33/t G&A, with off-site concentrate transport, treatment, and refining costs included in the NSR;
- LOM average metallurgical recoveries range from 50–61% for gold and 81–83% for copper;
- Overall pit slope angles range from 34–46°;
- Relative level restriction of 1,112 mRL to define the open pit to underground interface at approximately 50 m below the current LOM open pit design;
- Net smelter return (NSR) marginal cut-off value of C\$12.20/t to meet processing and general and administrative (G&A) costs.

The Mineral Resources potentially amenable to underground mining methods were constrained within a conceptual cave footprint, based on a potentially economic outline determined by the NSR of each block in the resource model below the open pit shell, assuming the following parameters:

- A mass mining method (block cave or sub-level cave) with no internal selectivity;

- 13.6 Mt/a mining rate;
- Copper price: US\$3.40/lb;
- Gold price: US\$1,400/oz;
- Exchange rate: C\$:US\$ of 0.75;
- Unit cost assumptions of C\$6.56/t mining, C\$10.05/t processing, C\$4.33/t G&A, with off-site concentrate transport, treatment, and refining costs included in the NSR;
- LOM average metallurgical recoveries range from 50–61% for gold and 81–83% for copper;
- Underground footprint based on a minimum approximate footprint of 160 x 160 m area with vertical walls and variable height of draw;
- NSR break even cut-off value of C\$21.00/t to meet mining, processing, and G&A costs.

The Mineral Resource estimates assume that the process method will be a conventional sulphide flotation producing a gold-bearing copper concentrate, and that there will be no penalties imposed on the concentrate.

Figure 14-2 is an example section showing the gold and copper grades in the open pit compared to the underground models.

14.13 Mineral Resource Statement

Mineral Resource estimates are reported with an effective date of 30 June, 2021, and are reported inclusive of those Mineral Resources converted to Mineral Reserves. Mineral Resources that are not Mineral Reserves do not have demonstrated economic viability.

Mineral Resources are tabulated in Table 14-2 for the Measured and Indicated Mineral Resources and in Table 14-3 for the Inferred Mineral Resources. Mineral Resources were estimated as at 31 March 2021, and depleted to 30 June 2021.

The Qualified Person for the estimate is Mr. Rob Stewart, FAusIMM, whose job title at Newcrest is Group Manager Resources. Mr. Stewart is a Newcrest employee.

14.14 Factors That May Affect the Mineral Resource Estimate

Factors that may materially impact the Mineral Resource estimates include:

- Changes to long-term commodity price and exchange rate assumptions;
- Changes in local interpretations of mineralization geometry and continuity of mineralized zones;
- Changes to geological and grade shape and geological and grade continuity assumptions;
- Changes to metallurgical recovery assumptions;

Figure 14-2: Cross Section of Gold and Copper Grades Showing Open Pit vs Underground Model (section 452680)

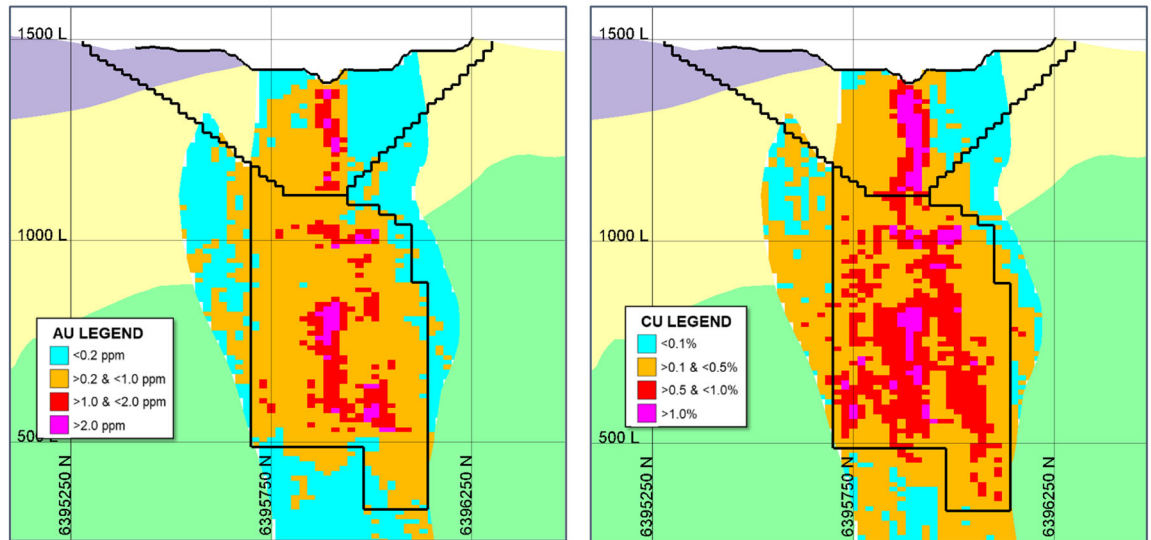

Note: Figure prepared by Newcrest, 2021. Section looks west. The current assumption is open pit resources are defined within an optimised pit shell limited to the 1112mRL and underground resources below the open pit resource

Table 14-2: Measured and Indicated Mineral Resource Statement

Resource Classification	Assumed Mining Method	Tonnes (Mt)	Grade		Contained Metal	
			Au (g/t)	Cu (%)	Au (Moz)	Cu (Mt)
Measured	Open pit and stockpiles	11	0.17	0.24	0.062	0.028
Indicated		290	0.28	0.34	2.6	1.0
Sub-total Measured and Indicated		300	0.28	0.33	2.7	1.0
Measured	Underground	—	—	—	—	—
Indicated		670	0.46	0.40	10	2.7
Sub-total Measured and Indicated		670	0.46	0.40	10	2.7
Total Measured and Indicated	Open pit and underground	980	0.41	0.38	13	3.7

Table 14-3: Inferred Mineral Resource Statement

Resource Classification	Assumed Mining Method	Tonnes (Mt)	Grade		Contained Metal	
			Au (g/t)	Cu (%)	Au (Moz)	Cu (Mt)
Inferred	Open pit and stockpiles	11	0.23	0.27	0.083	0.030
Inferred	Underground	180	0.32	0.30	1.8	0.54
Total Inferred	Open pit and underground	190	0.31	0.30	1.9	0.57

Notes to Accompany Red Chris Mineral Resource Tables:

1. Mineral Resources are reported with an effective date of 30 June 2021, using the 2014 CIM Definition Standards. The Qualified Person responsible for the estimate is Mr. Rob Stewart, FAusIMM, Group Manager Resources, a Newcrest employee.
2. Mineral Resources are reported on a 100% basis. Newcrest holds a 70% interest in the Red Chris Joint Venture.
3. Mineral Resources are reported inclusive of Mineral Reserves. Mineral Resources that are not Mineral Reserves do not have demonstrated economic viability.
4. Mineral Resources that are potentially amenable to open pit mining methods are constrained within a conceptual open pit shell that uses the following input assumptions: metal prices of US\$3.40/lb Cu, US\$1,400/oz Au; mining costs of C\$2.27/t mined, and process and general and administrative (G&A) costs of C\$12.20/t processed; a conventional sulphide flotation producing a gold-bearing copper concentrate; metallurgical recoveries that average 50-61% for gold and 81-83% for copper; a relative level restriction of 1,112mRL to define the open pit to underground interface; and overall pit slope angles that range from 34–46°. Mineral Resources are reported above a net smelter return of C\$12.20/t.
5. Mineral Resources that are potentially amenable to underground mass mining methods are constrained within a conceptual cave footprint, and reported using the following assumptions: metal prices of US\$3.40/lb Cu, US\$1,400/oz Au; mining costs of C\$6.56/t mined, and process and general and administrative (G&A) costs of C\$14.38/t processed; a conventional sulphide flotation producing a gold-bearing copper concentrate; metallurgical recoveries that average 50–61% for gold and 81–83% for copper; a relative level restriction of 1,112mRL to define the open pit to underground interface; and an underground footprint based on a minimum approximate footprint of 160 x 160 m area with vertical walls and variable height of draw. Mineral Resources are reported above a net smelter return of C\$21.00/t.
6. Tonnages are metric tonnes. Gold ounces are estimates of metal contained in tonnages and do not include allowances for processing losses. Copper tonnes are estimates of metal contained in tonnages and do not include allowances for processing losses.
7. Rounding as required by reporting guidelines may result in apparent differences between tonnes, grade and contained metal content. Rounding is to two significant figures.

- Changes to the input assumptions used to derive the conceptual open pit used to constrain the estimate;
- Changes to the input assumptions for assumed block caving operations;
- Changes to the NSR cut-offs applied to the estimates;
- Variations in geotechnical, hydrogeological and mining assumptions;
- Forecast dilution;
- Changes to environmental, permitting and social license assumptions.

14.15 QP Comments on “Item 14: Mineral Resource Estimates”

The QP is of the opinion that Mineral Resources have been performed using industry-accepted practices and conform to the 2014 CIM Definition Standards. Mineral Resource estimates are based on underground and open pit mining assumptions.

There are no other known environmental, legal, title, taxation, socioeconomic, marketing, political or other relevant factors that would materially affect the estimation of Mineral Resources that are not discussed in this Report.

15 MINERAL RESERVE ESTIMATES

15.1 Introduction

Mineral Reserves were converted from Measured and Indicated Mineral Resources. Inferred Mineral Resources were set to waste.

Mineral Reserves were estimated using open pit and block cave underground mining assumptions.

15.2 Open Pit

15.2.1 Optimization

Pit optimization and pit design assumptions are outlined in Section 16.2.3 and Section 16.2.4.

15.2.2 Model Coding

The material routing variable (Codee) defined the ore and waste classification. This variable was defined in the Red Chris mine model and executed by a MineSight software block model script.

Reserves were estimated from the resource block model with the following modifying factors:

- Pit design volumes (phase triangulations) for Phase 5, Phase 7 and Phase 8;
- Codee variable, which was the value descriptor for material routing and used in financial year (FY) FY22Q1 operating and sustaining capital assumptions used for net smelter return (NSR) calculations;
- Density was set to 2.78 t/m³ where a density value was missing in the resource model.

15.2.3 Cut-off

Ore types were based on marginal, break-even and elevated cut-offs. An NSR script calculated the value of each block model block by determining revenue after element recovery and selling costs. Three ore and three waste types were differentiated as set out in Table 15-1.

15.2.4 Dilution and Ore Loss

Dilution was assumed to be fully accounted for in the block model. No ore loss or dilution was applied to the Mineral Reserves.

Table 15-1: Ore Types by NSR Value

Cut-Off Conditions	Reserve Class	NSR Value (US\$/t)
NPR <2 and all Bowser Sediment	Waste	
NPR ≥ 2 (excluding Bowser sediment)	Waste	
NSR ≥ PCST + GA + (1 * SPRC)	Waste	10.61
NSR ≥ PCST + GA + (0.50 * SUS) + (1.0 * SPRC)	Ore	12.40
NSR ≥ PCST + GA + SUS + (0.2 * SPRC) + 5	Ore	17.47
NSR ≥ PCST + GA + SUS + (0.2 * SPRC) + 20	Ore	28.72
Default	Waste	

Notes: NPR = neutralizing potential ratio. NSR = value of ore as placed into crusher as processing decision point; NSR is fully costed. PCST = concentrator unit cost. GA = G&A unit cost. SPRC = stockpile recovery cost - 20% reclaim assumption. SUS = sustaining capital unit cost.

15.3 Block Cave Underground

15.3.1 Development of Mining Case

A block cave method was selected for the 2021 PFS based on:

- Deposit grade;
- Total potential operating margin of each method;
- Resource/ore conversion;
- Deposit shape, dimensions, and continuity;
- Potential mining rate.

Three macroblocks (MBs) were defined, MB1, MB2 and MB3. These have a total footprint size of approximately 750 x 400 m, and a total area of about 271,000 m². Two mining throughputs were reviewed, one, the Central Case (base case) at 13.6 Mt/a, and the second, Upside Case (alternative case) at 15 Mt/a. The macroblocks were sized and designed to produce up to 15 Mt/a, except for MB2, which had a limit of 7.0 Mt/a applied. Although the block cave has the potential to produce at a higher rate, the production rate for the purposes of the 2021 PFS was governed by the planned capacity of the process plant and potential upgrades.

Mining boundaries were determined using the commercially-available PCBC software to evaluate the potential column values over various elevations and over an extended area. A shut-off value of C\$21.00/t was used to determine the footprints; this was refined/validated with the final operating cost estimates.

Macroblock cave directions are mostly driven by geotechnical factors to ensure footprint long-term stability and reliability for continuous production. MB1 caving will be initiated from northwest corner of the footprint in order to avoid the principal stress being parallel or sub-parallel to caving front. MB2 caving is planned to start from the northeast corner towards the southwest. MB3 caving will be initiated from southeast corner of the footprint towards northwest

15.3.2 Shut-off Values

Due to the nature of the Red Chris orebody and the layout of the macroblocks, a specific optimized cut-off grade strategy was not adopted; instead, a specified shut-off value was used for each block and draw column. The Red Chris orebody has a distinct high-grade zone on which MB1 is located. Grade management is via MB1; which is designed to deliver as much as 15 Mt/a and to incorporate, where practical, the higher-grade columns such that high grade is not deferred or displaced reducing project value.

There is a significant grade drop after MB1, and because MB2 has a reduced production capacity of 7 Mt/a, the transition between blocks focuses on production continuity rather than grade optimization.

Due to the relatively consistent low grade of the blocks beyond MB1, a single shut-off value was adopted that was in line with the break-even costs, rather than elevating shut-offs between MB transitions. The shut-off values used are shown in Table 15-2.

Development ore is defined as having an NSR >\$16.50/t prior to the establishment of the underground conveyor system. A figure of \$16.50/t is the value of the processing plant feed that it would otherwise be displacing. Due to the elevated cost of trucking waste to the surface, post-commissioning of the conveyor system, the development ore cut off is \$10/t, which is approximately the same cost as processing.

15.3.3 Dilution

Dilution was modelled using the external drawpoint method to simulate surface toppling, rilling, and open pit failure. Dilution was defined as material below C\$20.70/t that enters the planned ore extraction via mixing. Dilution accounts for about 5.0% of the tonnage (approximately 20.2 Mt).

All unclassified and Inferred classification materials were set to waste and zero grade.

15.3.4 Input Values

The Mineral Reserves amenable to block cave underground mining were reported using:

- Gold price: US\$1,300/oz;
- Copper price: US\$3.00/lb;
- Canadian to US dollar exchange rate (C\$:US\$): 0.80;
- Australian to US dollar exchange rate (A\$:US\$): 0.75.

15.4 Mineral Reserves Statement

Mineral Reserves for the Red Chris Operations were reported using the confidence categories set out in the 2014 CIM Definition Standards.

Mineral Reserves are reported with an effective date of 30 June 2021 in Table 15-3.

Mineral Reserve estimates were prepared by Mr. Brett Swanson (MMSAQP), for the open pit Mineral Reserves and the Mineral Reserves in stockpiles. Mr. Michael Sykes (FAusIMM) is the Qualified Person for the estimated Mineral Reserves to be mined by underground block cave methods. Mr. Swanson and Mr. Sykes are Newcrest employees.

15.5 Factors that May Affect the Mineral Reserves

Factors that may materially impact the Mineral Reserve estimates include:

- Changes to long-term gold and copper price assumptions;
- Changes to exchange rate assumptions;
- Changes to metallurgical recovery assumptions;
- Changes to the input assumptions used to design the optimized open pit shell;
- Changes to the input assumptions used to derive the cave outlines and the mine plan that is based on those cave designs;
- Changes to include operating, and capital assumptions used, including changes to input cost assumptions such as consumables, labour costs, royalty and taxation rates;
- Variations in geotechnical, mining, dilution and processing recovery assumptions; including changes to designs as a result of changes to geotechnical, hydrogeological, and engineering data used;
- Changes to the NSR cut-off criteria used to constrain the open pit estimates;
- Changes to the shut-off criteria used to constrain the underground estimates;
- Changes to the assumed permitting and regulatory environment under which the mine plan was developed;
- Ability to maintain mining permits and/or surface rights;
- Ability to obtain mining permits and environmental approvals for underground mining;
- Ability to maintain social and environmental license to operate.

Table 15-2: Shut-off Values

Area	MB1	MB2	MB3
Mining *	4.99	5.96	5.96
Processing	10.36	10.36	10.36
Site general and administrative	4.33	4.33	4.33
Variable sustaining capital cost estimate	1.90	1.90	1.90
Total cost	21.59	22.55	22.55
Shut-off	22.00	22.80	22.80

Note: The mining costs in this table are steady state costs for each macroblock and vary from the LOM average costs.

Table 15-3: Mineral Reserves Statement

Reserve Classification	Mining Method	Tonnes (Mt)	Grade		Contained Metal	
			Au (g/t)	Cu (%)	Au (Moz)	Cu (Mt)
Proven	Open pit and stockpiles	—	—	—	—	—
Probable		75	0.36	0.42	0.86	0.31
Sub-total Proven and Probable		75	0.36	0.42	0.86	0.31
Proven	Underground	—	—	—	—	—
Probable		410	0.55	0.45	7.2	1.8
Sub-total Proven and Probable		410	0.55	0.45	7.2	1.8
Total Proven and Probable		480	0.52	0.45	8.1	2.2

Notes to Accompany Red Chris Mineral Reserves Table:

1. Mineral Reserves are reported with an effective date of 30 June, 2021, using the 2014 CIM Definition Standards. The Qualified Person responsible for the estimate of the Mineral Reserves amenable to open pit mining methods and in stockpiles is Mr. Brett Swanson, MMSAQP, and the Qualified Person responsible for the estimate of the Mineral Reserves amenable to underground block cave mining methods is Mr. Michael Sykes, FAusIMM, both of whom are Newcrest employees.
2. Mineral Reserves are reported on a 100% basis. Newcrest holds a 70% interest in the Red Chris Joint Venture.
3. Mineral Reserves that will be mined using open pit mining methods are constrained within a pit design that uses the following input assumptions: metal prices of US\$3.00/lb Cu, US\$1,300/oz Au; metallurgical recoveries that average 79% for copper and 51% for gold; mining costs of C\$3.2/t mined, and process and general and administrative (G&A) costs of C\$12.5/t processed; and pit slope angles that range from 34–46°. Mineral Reserves are reported above a net smelter return of >C\$15.5/t. Full mine recovery is assumed, and Mineral Reserves do not have additional dilution over that incorporated in the resource block model.
4. Mineral Resources that will be mined using underground mass mining methods are constrained within a block cave design that uses the following input parameters: metal price of US\$3.00/lb Cu, US\$1,300/oz Au; CA\$:US\$ exchange rate of 0.8; metallurgical recoveries that range from 81–86% for copper and 60–75% for gold; a life-of-mine operating cost of C\$20.34/t milled; and shut-off values of MB1: C\$22.00/t, MB2 and MB3: C\$22.80/t, resulting in an approximate dilution of 5%.
5. Tonnages are metric tonnes. Gold ounces and copper tonnes are estimates of in-situ metal and do not include allowances for processing losses.
6. Rounding as required by reporting guidelines may result in apparent differences between tonnes, grade and contained metal content. Rounding is to two significant figures.

Factors that are risk-specific to block cave operations, and which may affect the Mineral Reserves include: inrush of water into the underground workings including decline, cave levels and infrastructure areas; poorer rock mass quality and quantity than interpreted; inability to achieve planned decline development rates having impact on schedule and cost; incorrect estimation of cave propagation potentially leading to air blast; and damage to mine workings due to a seismic event.

15.6 QP Comments on “Item 15: Mineral Reserve Estimates”

The QP is of the opinion that Mineral Reserves were estimated using industry-accepted practices, and conform to the 2014 CIM Definition Standards. Mineral Reserves are based on open pit and underground mass mining assumptions. The Mineral Reserves are acceptable to support mine planning.

There are no other known environmental, legal, title, taxation, socioeconomic, marketing, political or other relevant factors that would materially affect the estimation of Mineral Reserves that are not discussed in this Report.

16 MINING METHODS

16.1 Overview

16.1.1 Open Pit

Open pit operations are conducted using conventional methods and a conventional truck and shovel fleet.

16.1.2 Block Cave

The Red Chris Operations have the potential to transition to block cave underground mining.

The proposed block cave considered in the 2021 PFS envisages development of three successive macroblocks (MB1, MB2, and MB3), using a conventional post-undercut, El Teniente-style layout (an intersecting pattern of parallel extraction and parallel drawpoint drives) with diesel load-haul-dump (LHD) machines to transport rock to a central crusher. From the crusher, rock will be transported to surface, where it will be directed either to the existing coarse ore storage stockpile via a transfer conveyor, or to a new coarse ore storage stockpile feeding a new grinding train. An underground mine dewatering system will pump collected water from sumps and settlers to the process plant for re-use. Primary access to the mine workings will be via an extension of the exploration decline.

The proposed mine plan uses technology conventional to block cave operations, including mine design and equipment. The planned mining equipment is conventional to block cave operations.

16.2 Open Pit

16.2.1 Geotechnical Considerations

The pit design parameters for Red Chris are designed to control bench scale stability and rockfall issues more than the global stability of the pit walls. In 2020, the geotechnical parameters were updated based on geotechnical and operating history at the Project.

Golder defined six geotechnical domains within the open pit (Figure 16-1). Recommended inter-ramp angles ranged from 41.9–52.8°. These were adjusted to take the pit ramps into account, leading to designed slope angles from 34–46°.

The greatest area of concern for stability is on the southern wall and in particular the Bowser Lake Group sediments. The results of the overall slope stability analyses indicated that the proposed south wall design is expected to exhibit adequate factors of safety with respect to overall slope circular type failure that involves failure from the crest of the slope through the South Boundary Domain and South Domain rock mass.

Two areas that show a factor of safety risk are associated with the Bowser Lake Group sediments near the pit crest, and are only problematic with elevated pore water pressures.

Figure 16-1: Open Pit Geotechnical Domains

Design Overview Figure

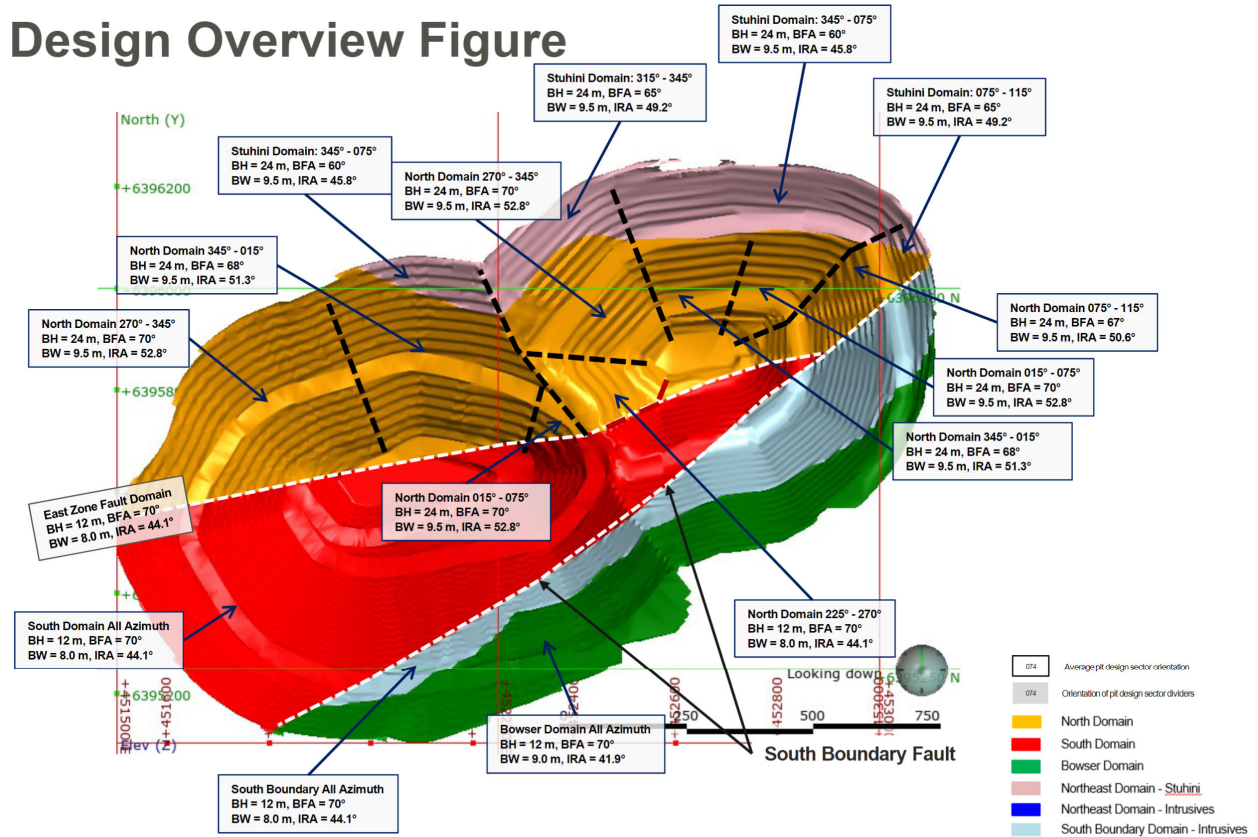

Note: Figure prepared by Golder, 2020.

The benches are expected to be relatively free draining, and significant pore pressures are unlikely to be generated at the crest of the slope. Consequently, provided that good quality wall-controlled blasting is used along the south wall, and relative pore pressures are appropriately maintained, the Bowser Lake Group sediments are expected to exhibit adequate stability with respect to inter-ramp scale circular failure through the south wall.

16.2.2 Hydrological Considerations

The Red Chris open pit is located on a plateau that water generally drains from north to south, following the topography. Seepage on the pit walls is minimal, is generally along major and continuous fault structures in the pit walls, and is currently not causing any signs of large-scale instability.

There is limited information available with respect to groundwater pressures within the Red Chris open pit. Approximately six standpipe piezometers were installed within the Main and East Zone Pit areas, prior to open pit development. These historic piezometers were located near the centre of the Main and East Zone Pits and indicated that the water

level was within approximately 10 m of ground surface prior to open pit development. The instruments were mined out during the early mining phases.

Precipitation at Red Chris occurs throughout the year as both rain and snow, with a period of spring snowmelt (or freshet). The majority of the water presenting to the open pit is derived from precipitation falling directly onto the pit walls. Groundwater is sourced from infiltration into near surface weathered country rock and open structures.

Water management in the pit is based around the use of surface drains to direct water from the benches and ramp towards sumps at the base of the pit from where it is pumped into the production circuit, either directly to the mill or TIA storage. No active or passive groundwater drainage is currently installed within the pit.

Groundwater levels are not considered a limiting factor on the internal ramp angles. Installation of vibrating wire piezometers and improving dewatering records is being undertaken as part of a pit optimization study.

16.2.3 Pit Optimization

The block model was depleted using the May 2021 end of month survey topography for use in pit optimisations. Phase designs that formed the basis of reserves were depleted using June 30 end of month survey topography. Values used for pit optimisation will not necessarily match those provided in the economic analysis.

Metal prices of US\$1,300/oz Au and US\$3.00/lb Cu were used in optimization.

Metallurgical recoveries were coded into the block model by metallurgical domain. The recovery formulas for each domain were originally a function of mill production rate and SAG throughput per shift. For pit optimisation, the original formulae were modified for a consistent 11 Mt/a Mill throughput.

Mining costs were based on a US\$2.27/t reference mining cost with an incremental bench sinking cost of US\$0.03/bench. The average cost applied to the optimisation was calculated to be US\$2.54/t. Long term processing costs average US\$13.60/t milled and are a combination of sustaining capital, general and administration (G&A) costs plus mill operating costs.

Selling costs included concentrate shipment, charges and refining penalties. The additional costs once the concentrate leaves the front gate average US\$18/oz Au and US\$0.505/lbs Cu.

The final design used the revenue factor 0.98 pit (Figure 16-2).

16.2.4 Pit Designs

The Mineral Reserve open pit design was subject to several limitations:

- Pit slopes are controlled by bench stability rather than global wall angle stability;
- Ore at the pit bottom can be mined by block cave or stoping;
- WRSF space is limited to 150 Mt unless other PAG disposal areas can be permitted;
- Pit optimisation guidance.

Figure 16-2: Whittle Shell Results Compared to Reserve Open Pit Design

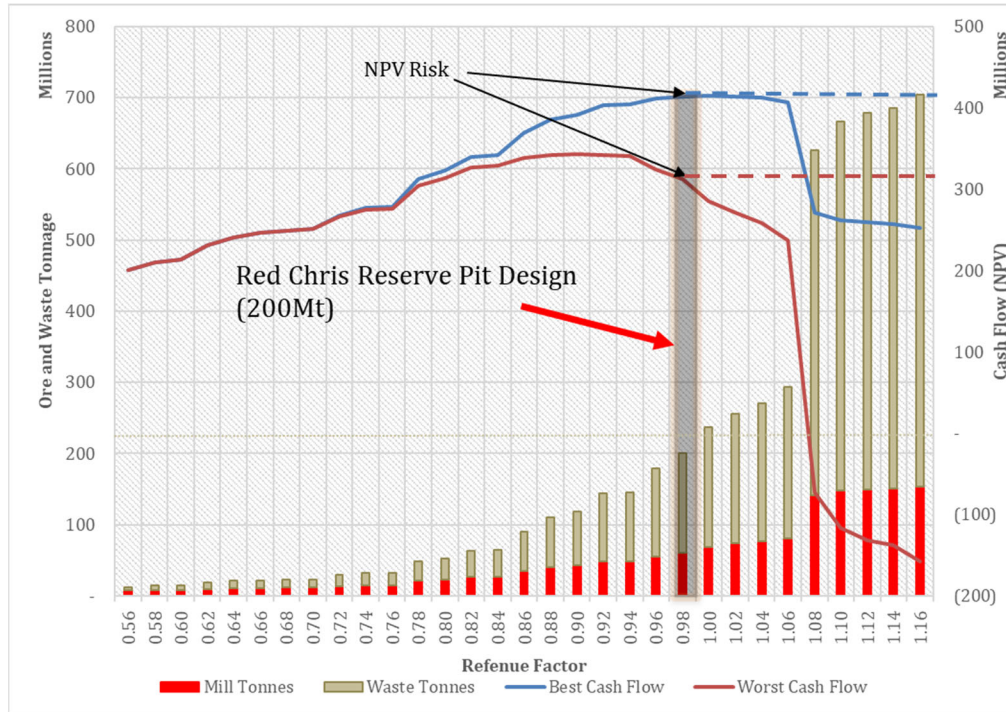

Note: Figure prepared by Newcrest, 2021.

The Mineral Reserve phase designs included the following design criteria and objectives:

- A minimum mining width of 70 m was targeted for all benches in both Main pit and East pit, including upper benches;
- The Main pit was mined before the East pit due to a lower strip ratio and better economics;
- The Main pit Phase 7 was designed maintaining the minimum mining width surrounding the existing Phase 4 design, and is integrated into the Phase 5 design;
- The East pit Phase 8 was integrated into Main pit Phase 7 and maintains the minimum mining width surrounding Phase 5.
- The east and west haulage merged at elevation 1330;
- The East pit ramp exit was aligned along the southern wall integrating with the existing ex-pit haul road alignment;
- Ramps were circular around pit limits with no switchbacks;
- Single lane ramps were used for the bottom four benches in the Main and East pits;
- 5 m fractional bench access was provided on either side of the ramp for service vehicles;

- Single lane ramps targeted a 28 m width at 10% grade;
- Default ramp widths targeted a 35 m width at 10% grade;
- The selective mining unit was 5 x 5 x 12 m for the grade control model and 20 x 20 x 12 for the reserves model. No additional dilution or mine recovery factors were applied;
- The mine schedule had a one bench per month per phase limitation to control the bench sinking rate.

The designs resulted in three pit phases, Phase 5 and Phase 8 in the East zone and Phase 7 in the Main zone (Figure 16-3).

16.2.5 Operations

The mine uses rotary blasthole drills (drilling variable diameter holes up to 311 mm) and 28 m³ electric hydraulic shovels loading 230 t capacity haul trucks from 12 m benches. The operation is supported by standard ancillary equipment including an 18 m³ front-end loader, track and rubber-tired-dozers, and graders.

Ore and waste are drilled and blasted together on 12 m benches and mined in a single pass. Where practicable, walls are drilled with a pre-split to assure stable wall rock conditions.

Ex-pit ore is allocated by gold and copper grade and either sent to the mill crusher pocket directly or sent to low-grade or mineralized waste stockpiles (material below Mineral Reserve cut-off grade).

NAG rock is used to line the WRSF and for construction. PAG rock is sent to designated PAG WRSFs.

16.2.6 Stockpiles

The Red Chris Operations use a grade binning ore control system based on NSR value of mineralized material. High-grade (Codee 1) and medium-grade ore (Codee 2) is generally fed to the crusher directly with low-grade ore (Codee 3) stockpiled for later use as required.

Mineralized waste is also stockpiled but is not estimated as part of the Mineral Reserves.

Figure 16-3 shows the spatial distribution of grade bin ore in relation to the Red Chris phase designs.

Due to the potentially acid forming nature of the ore, the low-grade stockpiles (including mineralized waste) overlie NAG material and are segregated from the WRSF. Environmental controls direct contact water away from at-risk catchments.

A mineralized waste stockpile has been retained as a potential buffer for the mill in the event of production interruptions from the mine, should low-grade ore stockpiles become depleted. Mineralized waste treatment would be contingent on sufficiently high metal spot prices to make processing the material economically viable.

Figure 16-3: Open Pit Phase Design Long Section

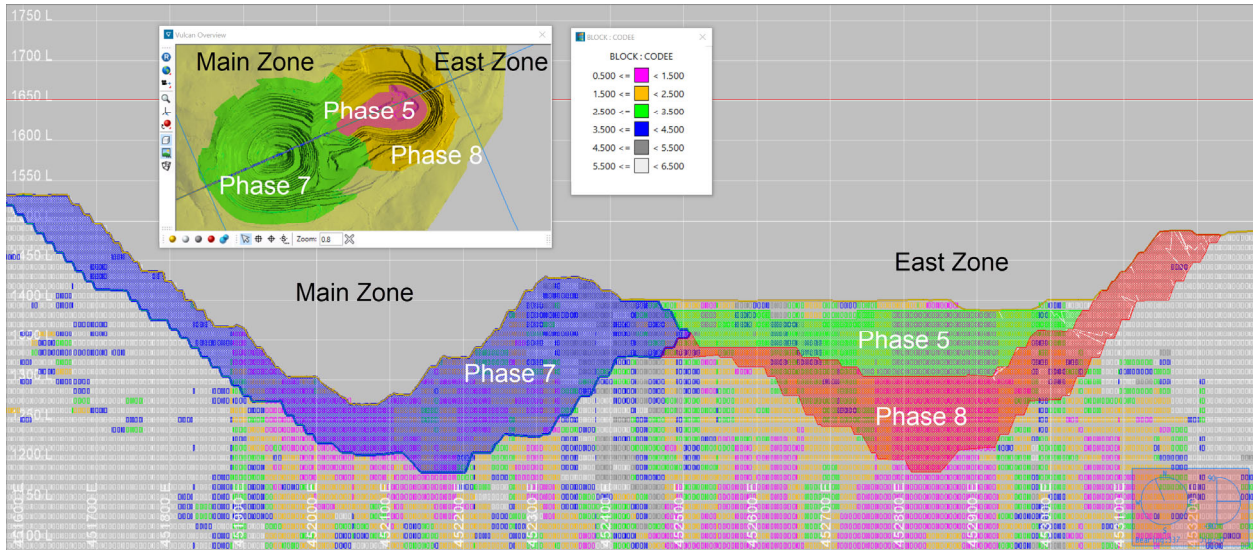

Note: Figure prepared by Newcrest, 2021. The blocks are coloured by the routing of material type code (Codee in legend key) with types 1, 2 and 3 being ore defined by NSR cut-off.

16.2.7 Waste Rock Storage Facilities

The locations of the WRSFs at the end of the open pit mine life are shown in Figure 16-4. NAG waste rock will generally be used as base below the PAG rock storage area, as road-topping material, or as general construction material. Depending on the available quantity of NAG rock, the base below the PAG waste will be designed from 1–5 m thick. Low-grade material is stockpiled on a base of NAG material. PAG waste is hauled to the north WRSF (north of the open pit limits) and placed upon a base of NAG waste material. Sufficient WRSF space was designed to store 150 Mt of NAG and PAG waste, assuming a loose density of 2.2 t/m³. The open pit schedule requires 120 Mt of waste be stored.

16.2.8 Equipment

The equipment requirements for the open pit LOM plan are summarized in Table 16-1.

16.3 Block Cave Underground

16.3.1 Geotechnical Considerations

16.3.1.1 Seismic Hazard Potential

Current seismic hazard assessment is based on regional earthquake reviews, and estimates derived from rock mass behaviour in numerical models. With the current reliability on key inputs (rock strength, structure material properties, stress field orientation, etc.), detailed prediction of seismic hazard is difficult.

Figure 16-4: Open Pit Stockpile and WRSF Location Plan

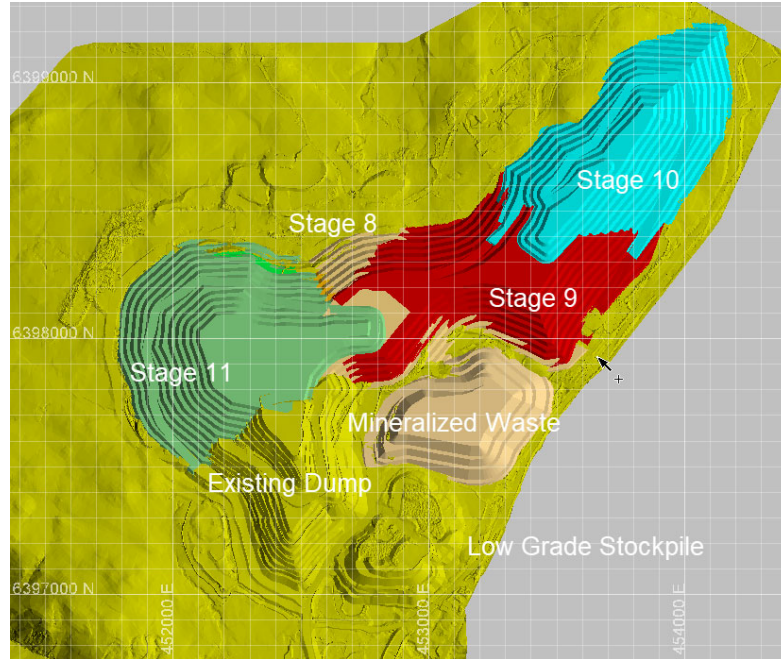

Note: Figure prepared by Newcrest, 2021. Map north is to top of figure.

Table 16-1: Key Equipment Requirements, Open Pit

Equipment	Type	Number
Shovels	Face shovels Hitachi EX3600-6-LD; P&H 2800XPB; Komatsu PC7000-6E	3
Drills	Atlas Copco PV351; Sandvik 650i, Sandvik 412i	5
Trucks	Dump trucks CAT 785D; CAT 793F; water truck CAT 773B	20
Graders	Caterpillar 16H, Caterpillar 24M; Caterpillar 16H3	3
Excavators	Hitachi ZX-870LC-5B, Komatsu PC2000, Komatsu PC35MR, Hitachi 290, Hitachi 470LC-5	5
Loaders	Caterpillar 980M cable reeler (LO320); Caterpillar 950G loader; Caterpillar 994H loader; Caterpillar 988F loader; Caterpillar 950H loader; Volvo LO309L FTMS tire manipulator; Caterpillar IT14 loader (Orica); CAT 930G stemming loader; Caterpillar 420F2 tractor backhoe	9
Dozers	D10 Caterpillar track dozer; Caterpillar 834 rubber tire dozer; Caterpillar D10T dozer.	5

16.3.1.2 Rock Mass Characterisation

The ground conditions within orebody at Red Chris Underground Mine are interpreted to be “very good”, based on data collected from 2018–2020. The rock mass rating (RMR) is in the range of 75–95 and the RQD is approximately >90. The rock mass is typically massive, strong, and brittle, with minimal natural open features. However, exceptions do occur adjacent to modelled mine-scale fault structures where conditions vary from blocky conditions to highly-broken zones of weak rock including the South Boundary Fault.

Data used for domain characterisation and strength parameters were collected from a zone close to economic mineralisation. Limited geotechnical data exist within the rock mass along the eastern corridor where access development is proposed. A detailed geotechnical data collection program was conducted at the site of the exploration decline boxcut. An extrapolation of ground conditions based on the general geology was made to this area. Additional data collection is in progress to improve current understanding.

The magnitude and direction of the in-situ stress was indirectly measured using acoustic emission (AE) and the results conflicted with the regional stress indicators such as geological features and the world stress map. The acoustic emission test results were adopted for the purposes of the 2021 PFS, in conjunction with the AE stress results, sensitivity analyses on stress magnitude and direction were completed in the geotechnical modelling.

16.3.1.3 Rock Mass Domains

Six geotechnical domains were assessed for the proposed underground development and cave extents.

Five domains were broadly based on the lithological units and they are, Bowser Sediments, Stuhini Volcanics, Stuhini Sediments, Porphyry Main and P2. As geotechnical data suggested that the vicinity of the South Boundary Fault is a zone of significantly poorer rock mass quality, the South Boundary Fault was identified as the sixth domain. Available data suggested the HW1, HW2 and EZF faults were more discrete structures with minimal impact on surrounding rock mass quality.

16.3.1.4 Pre-Conditioning and Fragmentation

All pre-conditioning works will extend from the extraction level of the macroblocks to within 75 m of the ultimate floor of the open pit (580 m above the underground footprint).

Fragmentation assessments were taken by Golder (Golder, 2021) and Itasca (Itasca, 2021). Cave fragmentation analyses concluded:

- Orebody pre-conditioning via high undercut, blast, and hydraulic means is required as >90% of the orebody can be considered massive rock;
- Primary fragmentation: primary fragments rather than being controlled by pre-existing discontinuities (e.g., joints) will likely be controlled by the level of stresses around the cave (above yielded zone) and strength and intensity of the weak features present in the rock mass;

- Secondary fragmentation: secondary fragmentation curves expected at the drawpoints show a percentage oversize decreasing from 45% to 5% and percentage fines increasing from 10–50% over the LOM.

16.3.1.5 FLAC3D Modelling

A large-scale FLAC3D model was constructed (Itasca, 2021) consisting of the regional extent of the Red Chris Operations, including the Red Chris final open pit geometry to capture the correct pre-mining in-situ stress condition (prior to cave mining).

Following initiation, the cave will propagate to the surface by approximately Q4 of year 2 to Q1 of year 3 of cave draw. The fracture limit was observed to breach the ground surface, showing the first signs of cave-induced subsidence between the fourth quarter of year 2 using AE stress and the first quarter of year 3 with a reduced stress in sensitivity analysis. The cave breakthrough (mobilized zone) was forecast during year 4.

The cave limit during the LOM in the south and southeast, and the potential for uncontrolled dilution, is controlled by the South Boundary Fault. The areal extent of the caving zone (fracture limit) will extend beyond the final open pit crest (Figure 16-5; Figure 16-6). The crater limit will be at the end of the LOM, at FY57, and the crater depth will be 350–400 m below the bottom of the final pit.

Modelled cave subsidence shows no major risks with respect to surface mining infrastructure or surface features such as Kluea Lake. A potential impact to Camp Creek was identified and a creek diversion should be considered. In addition, analysis with an updated in-situ stress measurement and rock mass characterisation should be undertaken and possible mitigation measures assessed.

Numerical modelling using FLAC3D was used to assess potential damage to the planned underground structures. The results suggest:

- All major chambers (i.e. crusher chamber) are stable and supportable with little risk of instability;
- The damage in the footprint before opening MB2 will be focused in the southwestern corner of MB1 due to the in-situ stress orientation;
- Elevated damage may occur to underground openings around the cave abutment; this damage is considered acceptable and the underground openings may require rehabilitation during operations;
- LOM ventilation raises may experience minor but acceptable damage.

The perimeter drives in the southeastern corner of MB2 (including the cross-cuts through the South Boundary Fault) are forecast to experience significant slabbing/cracking due to the influence of the south boundary fault, and will require rehabilitation during the LOM.

Figure 16-5: Projected Fracture Limit

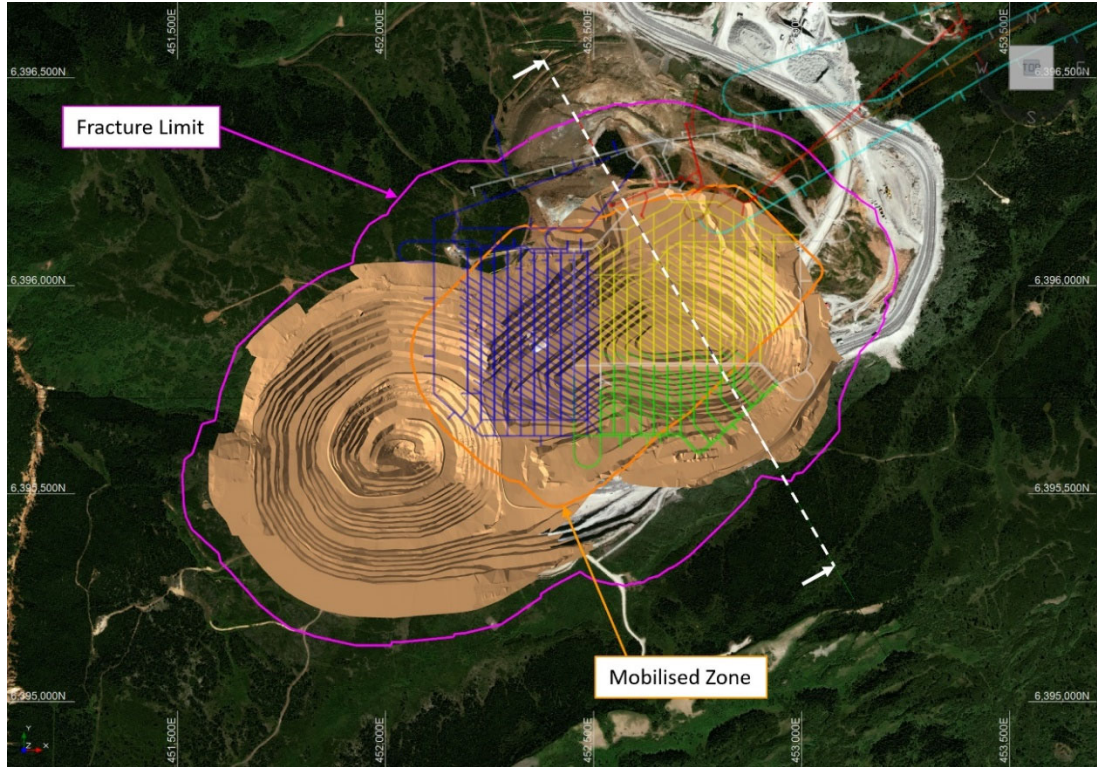

Note: Figure prepared by Newcrest, 2021. Colours that are not labelled represent the locations of the proposed underground infrastructure. Map north is to top of figure.

Figure 16-6: Schematic Cross-Section Showing Ultimate Caving Subsidence Zone

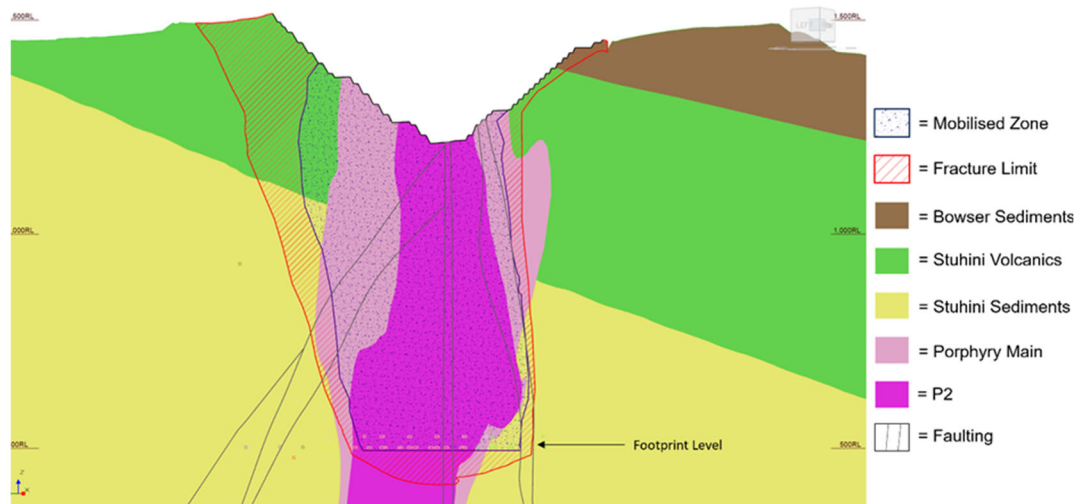

Note: Figure prepared by Newcrest, 2021.

16.3.1.6 Ground Support and Reinforcement

Static support assessment was applied to excavations less than 700 m below surface where the stress level (ratio between maximum stress and compressive strength of rock at the opening) is estimated to be <0.4 . Excavations >700 m below surface and/or impacted by the cave abutment stresses were assessed using a deformation-based approach.

Empirical assessments were completed using the Q-system (Barton et al, 1974) for static analysis. The majority of the main decline and conveyor decline will be excavated within the Stuhini Group sediments under purely static conditions, and will not warrant dynamic support application. An excavation support ratio of 1.6 was selected to represent permanent mine openings. The excavation support ratio safety requirements depend on the use (purpose) of the excavation. Typical ground support in static condition will be resin grouted bolt and weld mesh. Fibre-reinforced shotcrete and cable bolts will be required at large excavation such as transfer chamber

Other openings below 700 m depth where the stress level is estimated >0.4 will be evaluated using a dynamic support approach. Assessment of dynamic support was based on the Kaiser deformation-based design approach (Kaiser, 2020). Typical ground support in dynamic condition will be fibre-reinforced shotcrete, mesh (woven or minax), resin-grouted bolts, and cable bolts, or a combination of these methods.

16.3.1.7 Inrush

Based on the results of simulations done in the site-wide numerical groundwater flow model report by BGC Engineering Inc. (BGC), high water inflow rates into the block cave are not likely to occur. The simulation showed that seepage inflow rates increased as development progresses, from 200–222 m^3/hr , and that the zone of influence expanded as the block cave progressed, with expansion along the alignment of the orebody. Sensitivity analysis of the block cave inflow rates to variable recharge indicated a potential range of 185–355 m^3/hr . However, short-term temporal events (e.g., freshet or one-in-100-year 24-hour rainfall events) may result in groundwater inflows exceeding this range.

With increased rock mass characterisation, improved details on weathering, oxidation and alteration styles will be developed that can allow improved estimation of fine and muds creation, leading to inrush risks.

16.3.1.8 Monitoring

Cave markers and beacons will be seeded within the cave to provide greater understanding of the cave propagation rates (in conjunction with the microseismic system), and material flow in the broken caved material muck pile. A preliminary design was generated, using proprietary software to select detector locations (array), and simulate the detector arrays' ability to track beacons in the cave.

A microseismic monitoring system is planned to be in place prior to the commencement of the hydraulic preconditioning program. The system will use a combination of surface and underground boreholes equipped with geophones.

16.3.2 Hydrogeological Considerations

The hydrostratigraphic regime is divided into four different hydrostratigraphic units:

- Basement (including Bowser Sediments, Stuhini Sediments, Stuhini Volcanics and Porphyry): a fractured rock unit with hydraulic conductivity that decreases with depth. Not considered to be a water source for local communities or significantly contribute to regional flow within the Project area of influence;
- Mobilized zone: represents the muck pile after the development of the cave; creates an increased conductivity due to the fracturing and comminution of the rock mass;
- Fracture zone: a zone of hydraulic conductivity surrounding the mobilized zone, with hydraulic conductivities that are higher than the intact basement surrounding the cave;
- South Boundary Fault: fault zone; no indication that possible increases in hydraulic conductivity associated with changes in stress or relaxation of the faulting zone would have a significant influence on the inflows seen in the workings.

The groundwater flow direction, based on piezometer data, is closely related to topography, and dominantly west to east. The South Boundary Fault is interpreted to be acting as a hydraulic barrier. Piezometer measurements show there is little influence from the open pit on groundwater levels at the depth of the block cave.

The main source of water that will present to the underground was determined to come from direct precipitation (rain and snowmelt) flowing through the caved mass. Under natural conditions, it is assumed that most deep infiltration would report to surface drainage at lower elevations, similar to the surface drainage regime. Under current conditions, the shallow discharge regime is altered by the development of the existing pit, with flow towards the existing pit due to the changed piezometric elevation. With the propagation of the cave, it is assumed that similar changes will occur at the deeper elevations.

A numerical representation of flow was developed to characterize inflow groundwater flow rates and flow directions and estimate inflow rates to the underground workings. During the modelling process, various combinations of infrastructure, cave size and rainfall were modelled for consideration. The 24 hour return period precipitation values were used to estimate inflow. The average climate scenario was based on a precipitation value of 1.4 mm/d to estimate a reasonable baseline water production rate for the block cave and development. About 85% of the water reporting to the underground is forecast to come from the block cave or muck pile; however, the amount of flow is dependent on the estimated hydraulic conductivity of the muck pile and precipitation.

The underground water management system proposed for the Red Chris block cave was developed based on the initial model results and estimations. The planned water management capacity will range from 200 m³/hr during initial development to 1,500 m³/hr during mining of MB2 and MB3. The latter figure includes an allowance for a peak surge for a one-in-50 year event for 24 hours.

16.3.3 Design Considerations

Orebody characteristics indicated that block caving, sub-level caving, and sub-level open stoping were appropriate mining methods. Block caving was selected based on the potential to convert more of the resources to reserves, favourable production rate requirements and the potential to create the highest operating margin.

A trade-off study was completed on the footprint to surface material handling system (inclined conveyor vs shaft) with the inclined conveyor being the selected option.

The resource model and inputs were used in Footprint Finder (a component of the PCBC software suite) to determine the approximate elevation of the extraction level. The initial results indicated that footprint elevations between 450–600 mRL were applicable. These elevations showed consistent grade distribution allowing preliminary macroblock evaluation with PCBC to refine the footprint elevation selection process.

The final results indicated that to optimize the resource conversion the footprint should be separated into three macroblocks (MB1, MB2, and MB3). The optimal footprint elevation for MB1 and MB2 was 500 mRL, and for MB3 was 550 mRL. It was decided to keep the same 500 mRL footprint elevation for all three macroblocks to simplify the material handling system, thus reducing cost and complexity, and optimizing the value of the total project.

A schematic showing the footprint design is provided in Figure 16-7.

Based on the defined footprint targets, the extraction and undercut layouts were designed, and access, and the infrastructure including ventilation and materials handling development were added to build the total mine design. All design was undertaken adhering to mine design and geotechnical parameters.

Each macroblock footprint will consist of an extraction level, undercut level, and infrastructure development. A single crusher and tipple arrangement will be used to facilitate production for all macroblocks. A perimeter drive on the extraction and undercut level will provide extraction and drill drive access and ventilation to the working areas. The footprint will be ventilated via the access and conveyor declines as well as three ventilation raises extending from surface. A series of internal ventilation raises will provide exhaust ventilation for the crusher, conveyor, and tipple areas.

16.3.4 Mine Design

16.3.4.1 Declines

The exploration/access decline portal is constructed, and is located at the lowest accessible point above the ultimate height of the TIA. Access to the mine will be via two declines: exploration/access and conveyor declines (Figure 16-8). Both declines will have the portals located east of the mine footprint.

The exploration decline started construction in June 2021, and is the critical item required for Project development. It will be developed west towards the orebody, from which an exploration platform will be developed that will be used for drilling and LOM ventilation. From this point the decline will switch back to the east to intercept the third leg of the conveyor decline before switching back to the west towards the footprint.

Figure 16-7: Mining Footprint Design Schematic

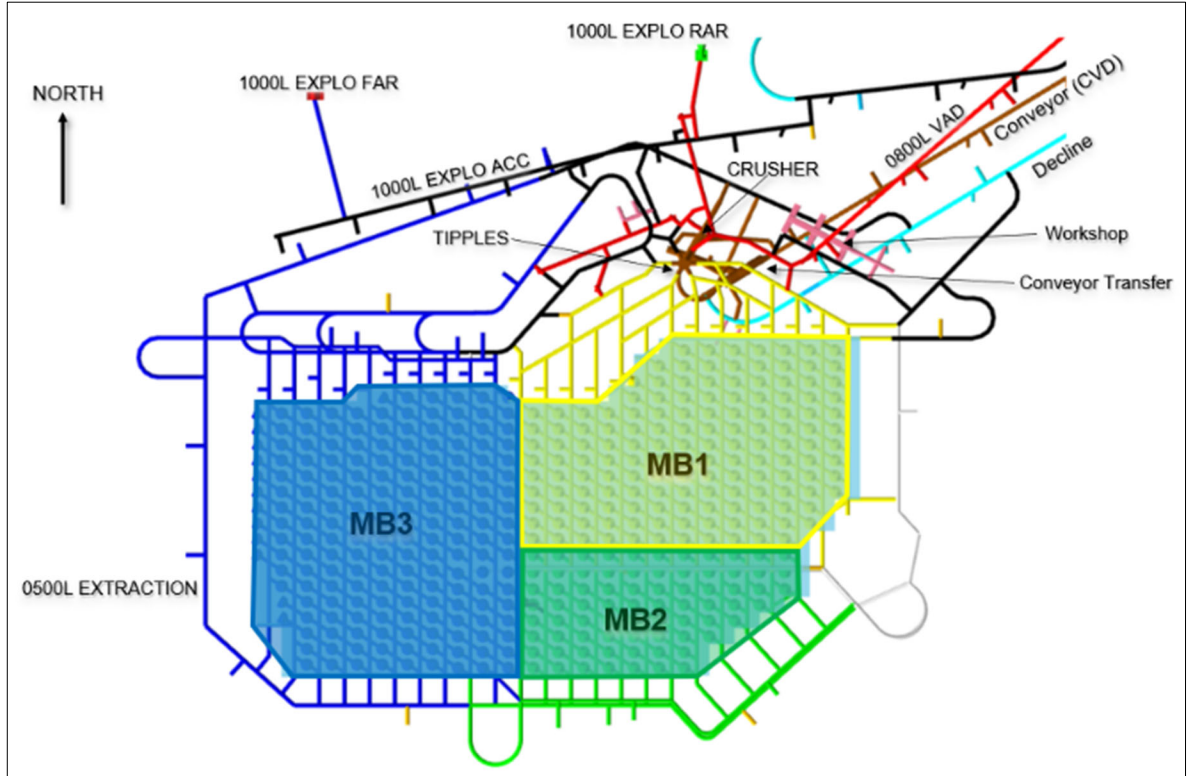

Note: Figure prepared by Newcrest, 2021.

Figure 16-8: Access Schematic Showing Conveyor and Decline Portals

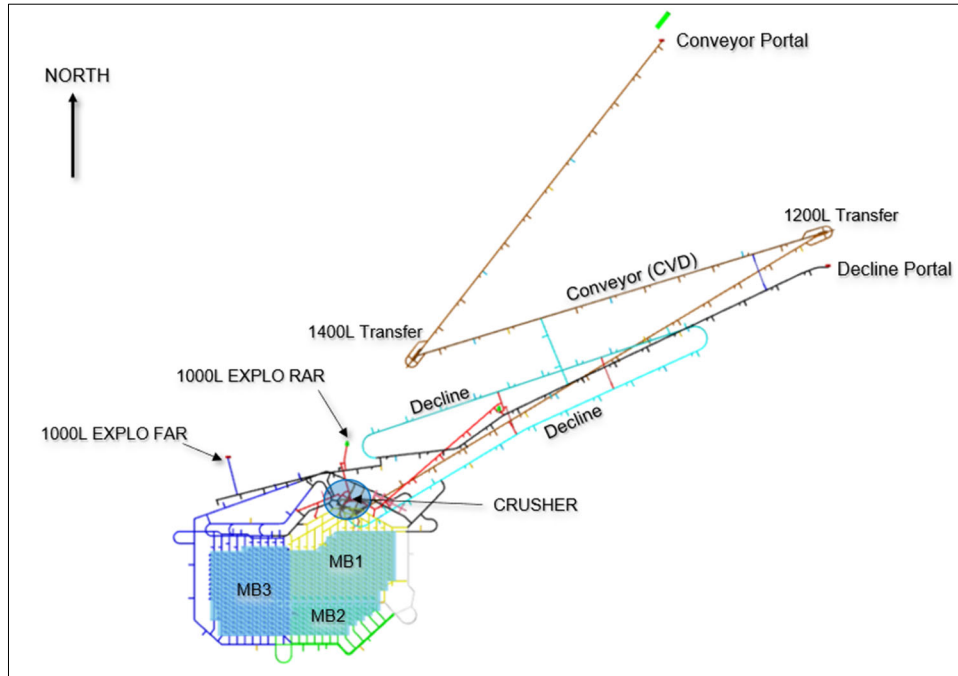

Note: Figure prepared by Newcrest, 2021.

The access decline gradient will be 1:6.5 because the decline will be used for haulage prior to the conveyor installation. The exploration decline will connect to the exploration level before connecting to the footprint. The exploration level will become a ventilation transfer drift once exploration drilling is completed.

The conveyor decline is designed to house a straight conveyor, minimize conveyor transfers, and have a minimum transfer angle of 11° . It was also designed to keep the transfer stations accessible from surface via a ventilation raise if required, as well as keeping the 1,200 L transfer north of the decline portal due to poorer ground conditions identified at depth south of the decline portal. The conveyor decline is designed at 1:5.3 gradient. There will be a lateral connection between the exploration decline and leg two of the conveyor decline. It is currently planned that traffic in the conveyor decline will be limited to conveyor maintenance and secondary egress.

Ventilation shafts from surface will be developed along the length of the access decline, to provide ventilation during decline development as well as supporting LOM ventilation requirements. The decline strategy is to have multiple touch points between declines allowing for the conveyor decline to be mined from multiple fronts so that the average development rate per heading can be reduced taking it off the project critical path.

The mine access will consist of about 17,400 m of lateral development and approximately 3,700 m of vertical development. The declines were designed with stockpiles and sumps

at spacings that will allow for future use of the excavations as refuge chambers, pump cuddies, sub-station cuddies, passing, and storage.

16.3.4.2 Primary Mine Design Parameters

The primary mine design parameters are summarized in Table 16-2. The parameters for the block cave design are outlined in Table 16-3. The cave schedule metrics are shown in Table 16-4. Designs included:

- The default density for caved material is 2.2;
- Drawbell spacing is 32 x 20 m;
- Draw cone radius is 14 m;
- PCBC Template mixing of 45° rilling and 40° toppling.

The layout includes declines, ventilation infrastructure, footprint access, crusher location, and footprint layout. Primary ventilation is achieved through three fresh air intakes, both portals and VR3, and two exhaust raises, VR1 and VR2.

16.3.4.3 Extraction Levels

Extraction levels for all macroblocks are based on the standard extraction level layout using an El Teniente layout with spacing of 32 x 20 m, a 60° turn-out angle and 5.4 m wide x 4.6 m high drives.

Extraction levels will be accessed from the north of each block, with access from both east and west of each block (to extraction and undercut levels) with an additional two internal ramps to the undercut level. This is to manage the air velocities and provides an additional means of egress on each level. The design inputs for the extraction levels are summarized in Table 16-5.

The extraction level was designed so that all drives in the three macroblocks drain to the south, away from the mine infrastructure that will be located on the northeast corner of the footprint. Extraction drives were designed at a gradient of 1:50 to the south, draining back to the perimeter drives that will be graded to drain to the sumps on the southern perimeter drives. This will also serve as flood mitigation by directing water away from critical infrastructure such as the crusher and main pump station.

From the perimeter drive sumps, water will be pumped to the main mine pump station that will be located near the conveyor transfer station on the 420 mRL level, below the extraction level. The mine pump station will then pump water to surface via a rising main that will be located within the decline via the conveyor portal to the process plant.

16.3.4.4 Undercut Levels

The undercut level will be 25 m above the extraction level to accommodate the high post undercut method by ramps up from the extraction level for each macroblock. The slot drill drive will be 20m from the closest drawbell, to allow appropriate stand-off.

Table 16-2: Underground Block Cave Mine Design Parameters

Item	Design Parameter	
Production rate	Design 15 Mt/a, 13.6 Mt/a base case	
Shaft dimensions and layout	Return 2 x 5.5 m \varnothing raisebored shafts (extended to footprint in legs)	
	Intake 1 x 4.5 m \varnothing raisebored shafts (extended to footprint in legs)	
	Internal shafts: 2 x 3.5m \varnothing for decline development ventilation	
Development gradients	Access declines	1 in 6.5
	Conveyor decline	1 in 5.3
	Ventilation (max.)	1 in 6.5
	Level development (max.)	1 in 6.5
	Level development (min.)	1 in 50
	Ventilation raises	70° min.
Development radii trucking	50 m	
Excavation sizes	Excavation type	Dimensions
	Access decline	5.5 mW x 6.0 mH (finished)
	Conveyor decline	5.5 mW x 6.7 mH (finished)
	Ventilation lateral connections	5.5 mW x 6.0 mH (finished)
	Inter level ramps/access	5.5 mW x 6.0 mH (finished)
	Perimeter drives	5.5 mW x 6.0 mH (finished)
	Drill cuddies	5.5 mW x 6.0 mH (finished)
	Sumps	4.7 mW x 4.6 mH (finished)
	Block cave undercut drives	5.0 mW x 4.6 mH (finished)
	Block cave extraction drives	5.0 mW x 4.6 mH (finished)
	Development stockpiles on declines	5.5 mW x 6.0 mH (finished)
	Development stockpiles in footprint	5.5 mW x 6.0 mH (finished)
	Geotechnical	Minimum intersection angle
Minimum pillar		1:2 ratio
Minimum conveyor transfer angle		11°
Densities	In-situ (dry)	2.78 t/m ³
	Bulk (volume)	1.6 t/m ³
	Bulk (load)	1.8 t/m ³

Table 16-3: Mine Design Assumptions

Item	Sub-Item	Approach	Comments
Mineable outlines	MB1, MB2, MB2	Economic boundary selection	Maximize value
Caving initiation	Undercut direction	NW to SE (MB1 & MB3) NE to SW (MB2)	Considering principal stress, structural direction, and mining sequence
	Critical hydraulic radius	25 m	With pre-conditioning
Undercut level	Undercut strategy	Post undercut	
	Undercut design	High with blast pre-conditioning	
	Undercut height	20 m	50 m including blast pre-conditioning
Extraction level	Layout	EI Teniente	
	Extraction drive spacing	32 m	
	Drawpoint spacing	20 m	

Table 16-4: Cave Metrics

Type	Access and LOM Ventilation	MB1	MB2	MB3	Total
<i>Development and Cave Establishment</i>					
Lateral m advance	17,411	19,612	7,154	17,608	61,786
Raisebore 3.0 m	792				792
Raisebore 4.5 m	970				970
Raisebore 5.5 m	2,225				2,225
Cablebolt (m)	48,526	96,490	27,153	47,388	227,702
Tonnes ore		1,877,117	783,444	1,982,149	4,642,710
Tonnes waste	1,975,164	748,425	257,202	587,044	3,567,836
Total tonnes	1,975,164	2,625,542	1,040,646	2,569,193	8,210,546
Drill (m)		844,043	431,711	958,250	2,234,003
Concrete roadways (m)		5,651	2,832	4,224	12,708
Preconditioning drill (m)		8,275		7,430	15,705
Preconditioning fractures		1,038		968	2,006
<i>Cave Production</i>					
Ore tonnes (Mt)		154.6	75.3	171.0	400.89
Au g/t		0.77	0.41	0.43	0.56
Cu %		0.59	0.37	0.37	0.46

Table 16-5: Extraction Level Metrics

Item	Units	MB1	MB2	MB3
RL	m	500	500	500
Lateral development	m	9,340	3,970	9,620
Undercut area	m ²	103,370	54,020	113,590
Number of drawbells	each	146	74	183
Number of extraction drives	each	14	12	10
Production drilling	m	209,660	106,260	258,120
Concrete road	m	7,000	1,480	4,220

The total development metres and drilling required on the undercut level in each macroblock is provided in Table 16-6.

The undercut level drainage design is similar to that described for the extraction level.

16.3.4.5 Production Sequence

The mining sequence will be, in order, MB1, MB2, and MB3. This sequence is based on mining the high-grade portion of the Mineral Reserve first (MB1). MB2 will be a southern extension of MB1, and with cave rules and stress orientation dictating that MB3 is opened from southeast to northwest, MB2 must be opened prior to MB3.

Development and operation will be as follows:

- Exploration decline;
- Conveyor declines and access decline (and required ventilation infrastructure);
- First footprint access reached;
- MHS mass excavation;
- MHS construction and ventilation infrastructure;
- MB1 development;
- MB1 first drawbell firing and cave establishment;
- MB1 full production;
- MB2 development starts;
- MB2 first drawbell firing and cave establishment;
- MB3 development starts;

Table 16-6: Undercut Level Metrics

Item	Units	MB1	MB2	MB3
Elevation	mRL	530	530	530
Lateral development	m	4,190	1,750	4,350
Number of drill drives	each	14	12	10
Production drilling	m	634,390	325,450	700,130

- MB3 first drawbell firing and cave establishment;
- MB3 full production;
- End of MB3 production.

MB1 caving will be initiated from the northwest corner of the footprint in order to avoid the principal stress (determined via AE testing) being parallel or sub-parallel to caving front. MB2 caving is planned to start from the northeast corner towards the southwest in order to avoid the caving front being parallel or sub-parallel to the South Boundary Fault located at the southeast corner of the footprint, start caving from the MB1 cave, and to start caving from a tight footprint area to a wider undercut area. It will also commence in the stress shadow provided by the MB1 cave against the principal stress. MB3 caving will be initiated from southeast corner of the footprint towards the northwest to avoid the principal stress being parallel or sub-parallel to the caving front, and to start caving from the existing cave.

16.3.5 Materials Handling System

A schematic showing the planned material handling system is included as Figure 16-9.

A single crusher was designed to service the three macroblocks, and will be located to the northeast of the footprint, 95 m north of MB1. The crusher will be offset 95 m from the closest undercut, to place the crusher outside the effects of mining-induced abutment stress.

The footprint material handling system will direct feed the crusher with LHDs, with five tip points on the 500 mRL above a ROM bin at the extraction level. The crusher will be serviced by a five-tipple dump arrangement with a sixth access for ventilation and loader access to the rock box.

There will be an equal number of extraction drives reporting to each tipple from MB1 and MB2 to enable as high a production rate as possible with as little loader interaction as possible. A dedicated haulage loop was designed for MB3 to access the western side of the tipple arrangement using trucks.

Crushed ore will be transferred to the decline conveyor via a fine ore bin, from where it will progress to the collection conveyor and the transfer station on the 420 mRL. From the conveyor decline, ore will be transported to surface with additional transfer stations located at the 1,200 and 1,400 mRLs.

Figure 16-9: Material Handling System Schematic

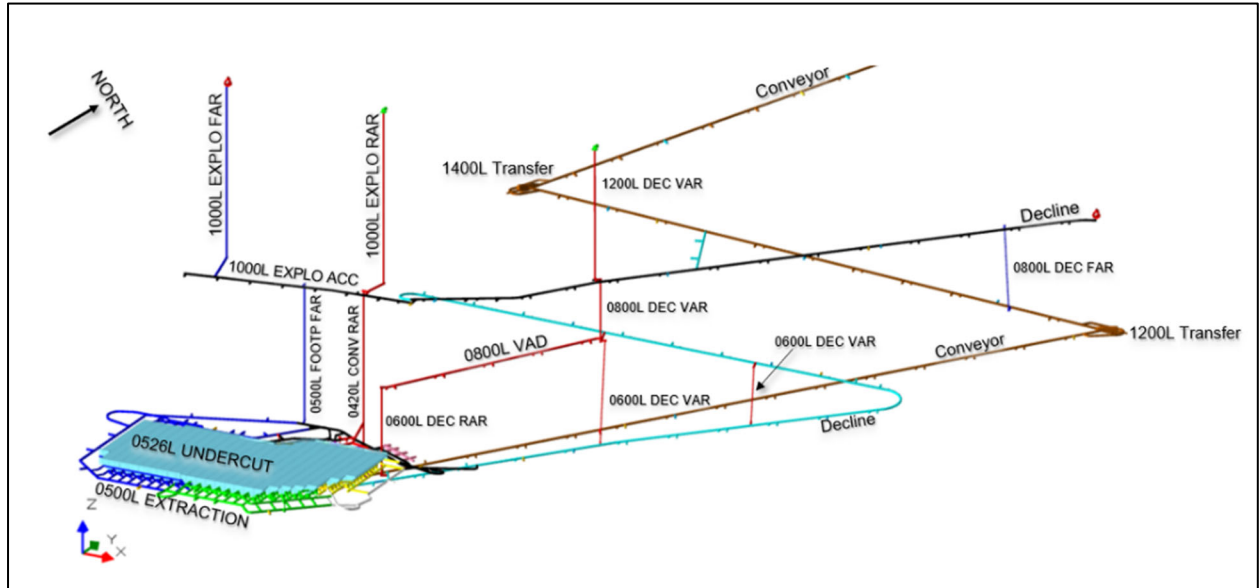

Note: Figure prepared by Newcrest, 2021.

Conveyors will be mounted from the backs, with a 3.7 m minimum height clearance for service vehicles.

16.3.6 Ventilation

The ventilation system was designed to meet the required mines regulations outlined in the Health, Safety, and Reclamation Code for Mines in British Columbia, and modelled using Ventsim.

The mine will be ventilated by a “pull” or exhausting type ventilation system and was designed based on the use of diesel equipment. The primary mine ventilation fans will be located at the primary exhaust airways of the mine and will develop sufficient negative pressure to ensure all workplaces are supplied with the required fresh air such that contaminants are removed to the exhaust air system and ultimately to the surface. Airflows were allocated based upon maintaining ventilation for all concurrent mine activities.

VR1 and VR2 will be the primary exhaust airways, and VR3 the intake airway (Figure 16-10). The primary fan exhaust fan installations are planned to be located on surface and will be controlled with variable frequency drives to allow fluctuation in air volumes during the life of the mine as well as ensure effective dust and contaminant removal.

Fresh air will be sourced from VR3 as well as the access and conveyor decline portals. After exiting the primary fresh air routes, fresh air will be distributed through each of the declines to the production panel accesses. Airflow for each extraction access will be controlled by fans located above ventilation doors positioned at the beginning of each extraction drift.

Figure 16-10: Ventilation Schematic

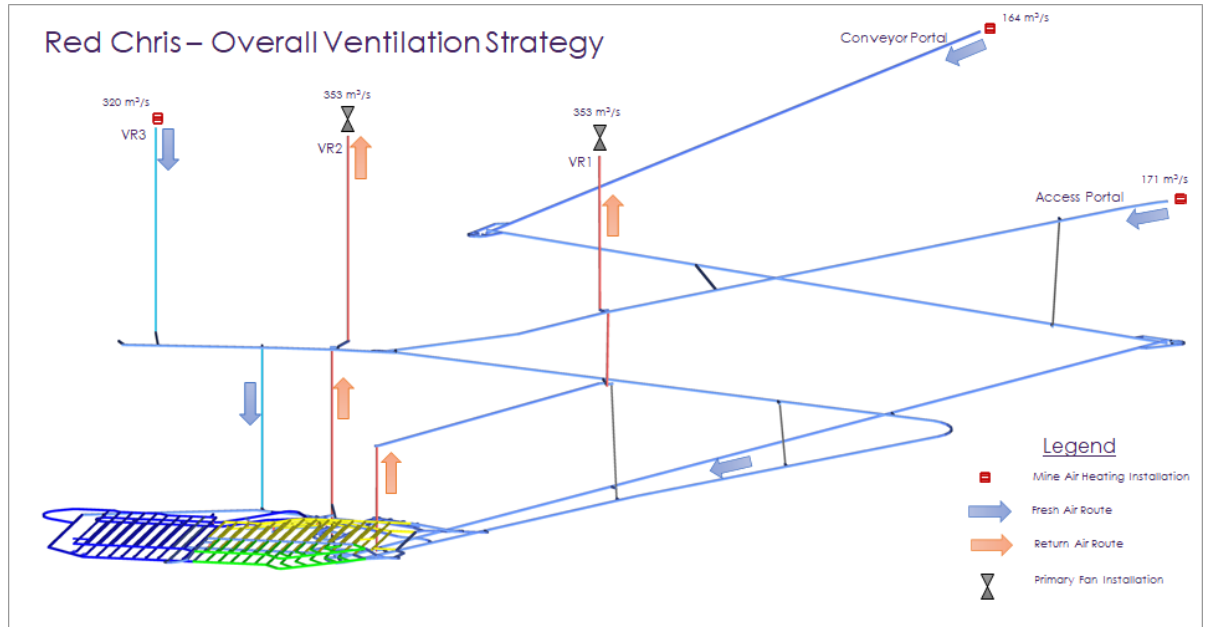

Note: Figure prepared by Newcrest, 2021.

Air direction will be from the access towards the crusher tip point. Air will be exhausted through the crusher direct to the exhaust so that air contaminated by dust will not return back towards the panel.

Raiseboring was selected as the preferred method of excavation for the ventilation raises.

16.3.7 Heating

Heating will be employed. For both of the portals, the heating system is required to raise the temperature from a design minimum of -35°C up to +2°C. For VR3, the first trafficable airway will be at the extraction level. Air will be heated to -7.5°C, as due to auto-compression effects, the air will increase in temperature as it descends. The minimum targeted delivery air temperature for trafficable airways is 2°C.

16.3.8 Waste Disposal

All waste is scheduled to be trucked out of the mine via the access decline portal, except for waste development directly related to conveyor decline development, which will use the conveyor portal where possible. Ore is scheduled to be trucked out of the access decline until Q4 FY26; after that date the materials handling system will be complete and ore will be hauled via conveyor to the surface.

The block cave mine will produce about 2.9 Mt of PAG waste, which will be stored on the existing permitted facilities. NAG material will be used for site construction, including the TIA.

16.3.9 Underground Infrastructure

The mine design will include the following infrastructure:

- Primary ventilation network including fans, doors and barricades;
- Underground workshop, offices, refuge stations;
- Dewatering facilities to handle snow melt and spring freshet with a maximum inflow of 1,500 m³/hr (one-in-50 year event) after the cave reaches the surface;
- Utility and fire water distribution;
- Electrical power supply and distribution;
- Diesel fuel supply and distribution;
- Concrete supply and distribution.

16.3.10 Equipment

Total fleet requirement during development shown in Table 16-7 and the production equipment is shown in Table 16-8.

16.4 Production Schedule

16.4.1 Open Pit

The Red Chris East Zone is currently being mined by open pit mining. The open pit mine is due for completion of the final phase (Phase 8) in FY26, producing an estimated total of 63.6 Mt of ore from Q4 FY21 to Q4 FY26. The first cave ore from MB1 (located directly below Phase 8) is scheduled for 2H FY26, with full production from MB1 in FY30. During the block cave production ramp-up the process plant feed will be supplemented by stockpiled ore.

A figure showing the remainder of the open pit mine life with the proposed transition to the block cave operation is provided as Figure 16-11.

16.4.2 Block Cave Underground

The mining sequence will be, in order, MB1, MB2, and lastly MB3 (Figure 16-12).

16.4.3 Combined Open Pit and Underground

The combined open pit and underground production schedule forecast is shown in Figure 16-13. The forecast tonnage profile transitions from a predominantly open pit feed in FY26 to an exclusively underground mill feed in FY30 when the nameplate capacity of 13.6 Mt/a is scheduled to be reached.

Figure 16-14 is a forecast metal production profile. In this figure, the gold equivalent value is based on assumptions of a gold price of US\$1,500/oz, copper price of US\$3.30/lb, C\$:US\$ exchange rate of 0.80, LOM gold recovery of 66%, and LOM copper recovery of 82%.

Table 16-7: Mine Establishment Equipment List (Development and Cave Establishment)

Item	No. in Operation
Jumbo: split feed	4
Cablebolter: Sandvik DS421	2
Shotcrete Machine: MacLean SS3	2
Agitator Truck (6 m ³): MacLean AG3	3
Dev. charge up: Normet Charmec 1610B	2
LH drill: Atlas Copco E7C	4
Development loader: Sandvik LH621	3
Truck: Sandvik TH663	8
Prod charge up: Dyno Truck	2
Integrated tool carrier: Volvo L90F	2
Integrated tool carrier: Volvo L120F	3
Service truck	1
Flatbed truck	1
Water truck	1
Grader: CAT 12M	1
Backhoe	1
Bus	2

Table 16-8: Production Equipment List

Item	No. in Operation	Replacement No.	Total Number
Production loader: Sandvik LH621/Cat 3000	10	48	58
Truck: 40 t underground or Volvo FMX	8	12	20
Secondary break loader: Sandvik LH621	3	15	18
Water cannon: MacLean WC3	3	15	18
Secondary drill: MacLean BH3	3	15	18
Rockbreaker: Sandvik 514 loader	3	15	18
Grader: Caterpillar 12M	1	5	6
Water cart: Caterpillar 730	1	5	6
Smooth drum roller: Caterpillar CS56	1	5	6
Skid steer cleanup: Bobcat S770H	1	5	6
Integrated tool carrier: Volvo L120F	2	12	14
Light vehicle	11	50	61

Figure 16-11: Open Pit to Underground Transition

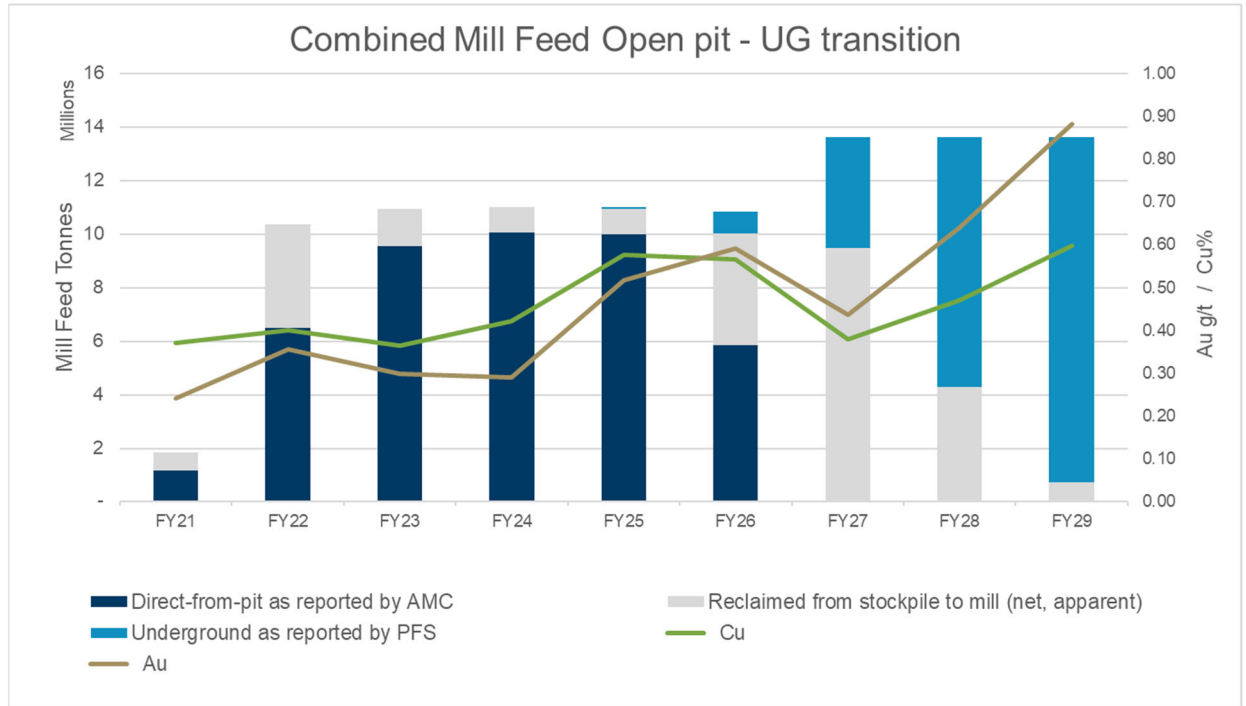

Note: Figure prepared by Newcrest, 2021. Calendar years shown for the block cave are conceptual. PFS is the 2021 PFS. AMC is a third-party consultant who provided inputs into the open pit mine plan.

Figure 16-12: Central Case Production Sequence

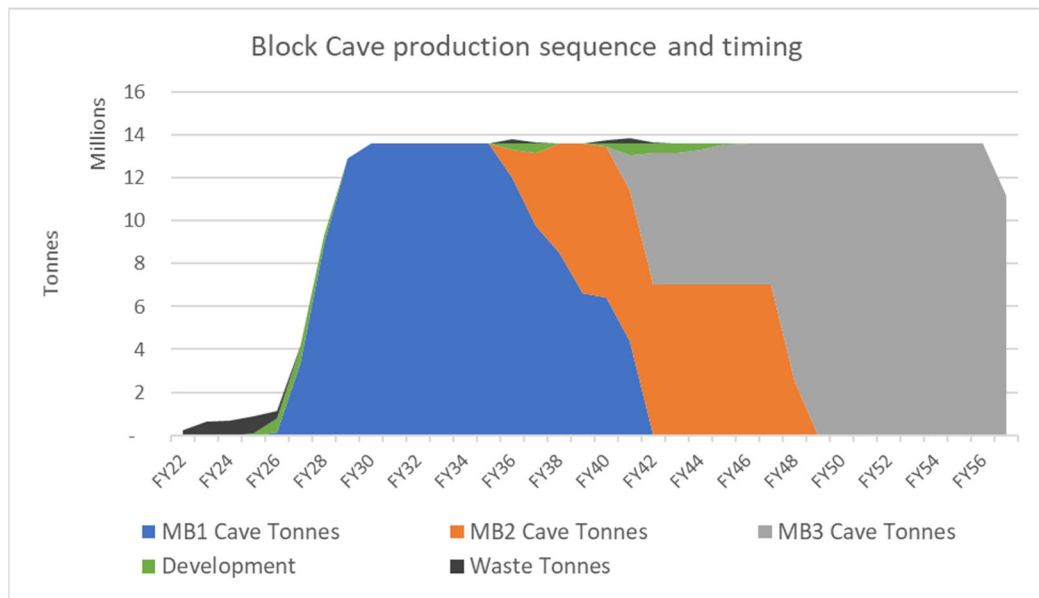

Note: Figure prepared by Newcrest, 2021. Calendar years shown for the block cave are conceptual.

Figure 16-13: Forecast Combined Production Schedule

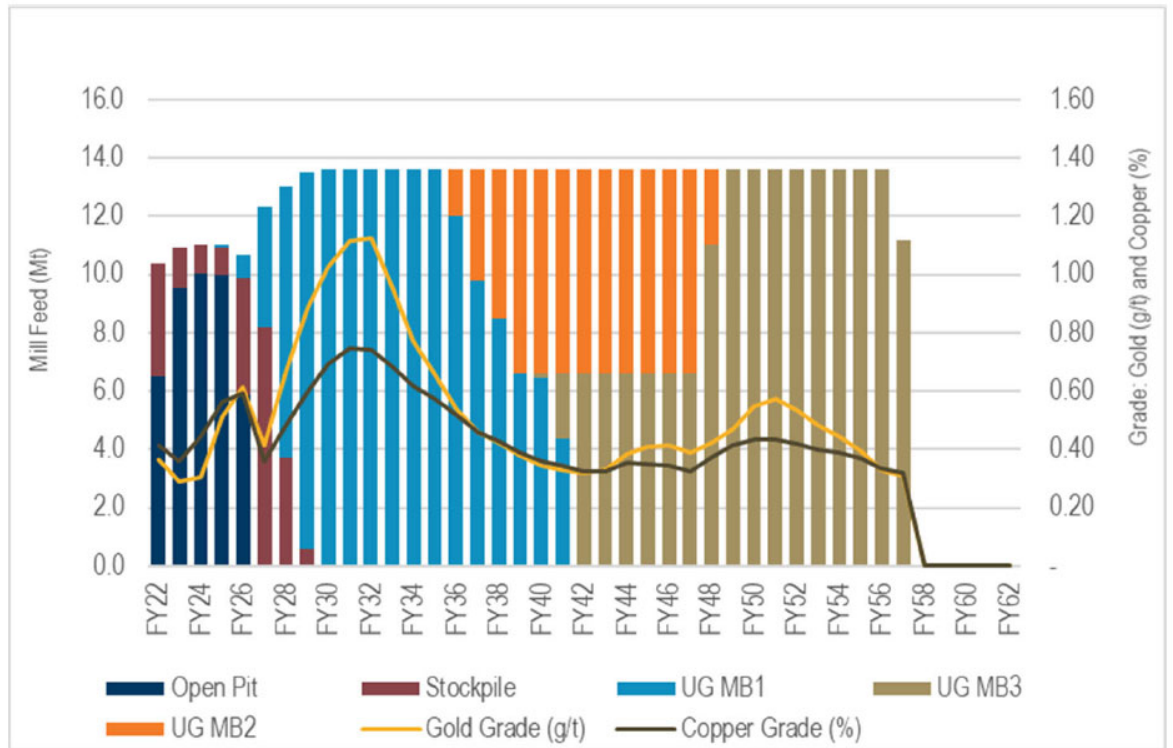

Note: Figure prepared by Newcrest, 2021. Calendar years shown for the block cave are conceptual.

Figure 16-14: Forecast Metal Production Profile

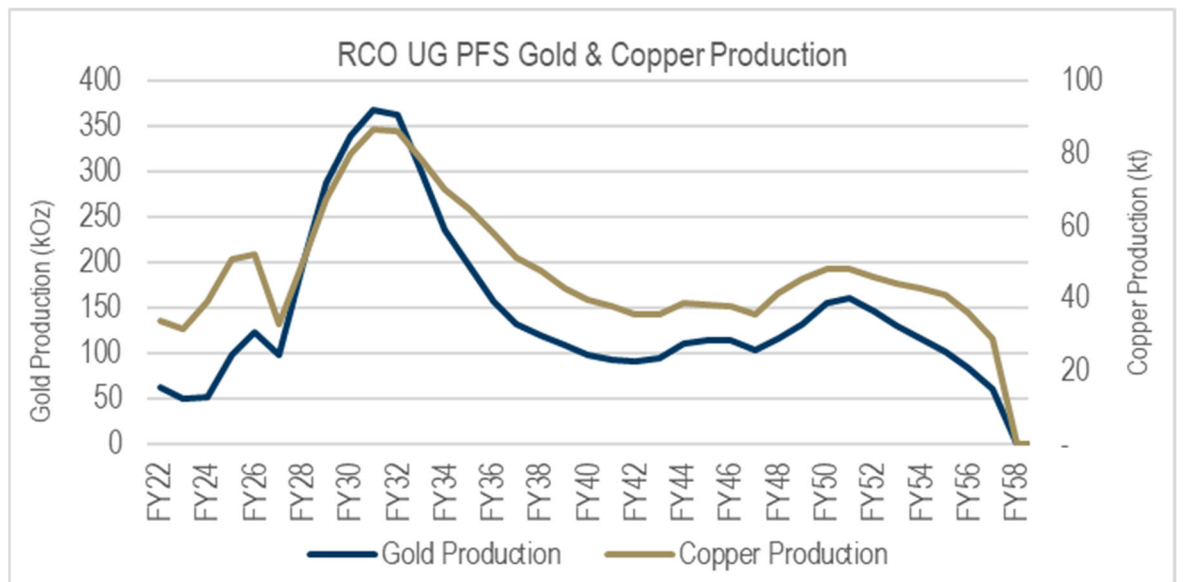

Note: Figure prepared by Newcrest, 2021. Calendar years shown for the block cave are conceptual.

The equation is:

- Gold equivalent production (by-product basis) = recovered gold oz + (copper price US\$/lb) x 2,204 / (gold price US\$/oz) x (recovered copper tonnes).

16.5 QP Comments on “Item 16: Mining Methods”

The QP notes:

- Open pit operations are conducted using conventional methods and a conventional truck and shovel fleet;
- Open pit operations are scheduled to FY26. The first cave ore from MB1 (located directly below Phase 8) is scheduled for 2H FY26, with full production from MB1 in FY30. During the block cave production ramp-up the process plant feed will be supplemented by stockpiled ore;
- The proposed underground mine plan uses block cave methods; three macroblocks are planned to be mined. The mining sequence will be, in order, MB1, MB2, and lastly MB3;
- The projected underground mine life is from FY26 to FY57, with nameplate capacity of 13.6 Mt/a scheduled to be reached in FY30;
- The planned equipment fleet is conventional to block cave operations.

17 RECOVERY METHODS

17.1 Introduction

Plant design for open pit ores was based on the metallurgical testwork assuming open pit mining methods outlined in Section 13.1, and was a standard porphyry copper flowsheet employing SAG and ball milling, flotation, regrinding, thickening and filtering to produce a copper concentrate at a moisture content of 8% for export.

Subsequent to the initial construction, the plant has undergone the following changes:

- Installation of pebble bypass system on the SAG mill. The main purpose of this change was to allow continued operation in the event of breakdowns in the pebble recycling system;
- Installation of an additional 160 m³ rougher flotation cell for a copper roughing/sulphide scavenging duty to increase rougher flotation residence time;
- Installation of a third flotation column to increase capacity of the cleaner circuit and alleviate flotation constraints at high throughput rates and high copper head grades.

The 2021 PFS metallurgical testwork program confirmed that a flowsheet incorporating crushing, grinding, flotation, and concentrate dewatering was suitable for the planned block cave material.

17.2 Plant Design

The plant consists of a SAG mill–ball mill–pebble crushing (SABC) comminution circuit housed in a single process building. The target grind size is a P₈₀ of 150 µm, with throughput taking precedence over grind size, resulting in typical grind sizes closer to 170–180 µm.

The flotation circuit as of May 2021 consisted of:

- Copper rougher: five Outotec TC-200;
- Mixed duty (copper rougher/sulphide rougher): one TC-200 and one TC-160;
- Regrind: primary ball mill in series with a secondary Vertimill targeting a regrind size P₈₀ of 30 µm;
- Cleaner circuit: two cleaner columns and a bank of five Outotec TC-50 cleaner scavengers;
- Concentrate storage tank, thickener, and pressure filter.

Subsequently, in June 2021, the third flotation column was commissioned.

The flotation circuit is configured to produce a copper concentrate with a grade of 23–24% Cu. Originally configured as a two-stage cleaning circuit, the plant was often

operated with only a single stage of cleaning due to insufficient capacity in the cleaner columns. This no longer occurs as the third flotation column is in place.

The process plant produces two tailings streams, nominal non-acid-generating (NAG) tailings and potentially acid generating tailings (PAG). The plant is operated to ensure that NAG tailings are deficient in sulphide content such that the neutralizing potential ratio (NPR) is greater than 2. NPR is a ratio of the neutralizing potential (NP) of carbonates vs. the acid potential (AP) of sulphides. In some cases, the NPR criteria can be achieved by operating a copper rougher-only circuit. When sulphur feed grades are high, insufficient pyrite is removed from the copper rougher tailings to meet target NPR criteria. In these cases, it is necessary to operate the last one or two nominally rougher cells in a pyrite scavenger duty.

PAG tailings are nominally cleaner-scavenger tailings and also include pyrite scavenger concentrate when the sulphide scavenger mode is in operation. PAG tailings are much higher in sulphide (pyrite) content than NAG tailings and are currently required to be deposited sub-aqueously in the TIA.

A flowsheet of the circuit as at May 2021 is provided in Figure 17-1. The current plant equipment is discussed in Section 17.4.3.

Process improvements are underway, and include:

- Installation of a third Eriez Cavitation Tube Column in the cleaners, which started commissioning in June 2021;
- Installation of two pre-rougher duty Eriez StackCells, due to be completed by Q1 2022.

Newcrest is investigating the installation of a tailings thickener for NAG cyclone overflow. A new tailings cyclone cluster will be installed adjacent the tailings thickener, should this project proceed.

17.3 2021 PFS Process Alternatives Options

The 2021 PFS evaluated process plant upgrades required to meet the different ore characteristics of underground ores compared with open pit ores, specifically increased hardness and higher copper head grades.

Figure 17-1: Plant Flowsheet (as at May 2021)

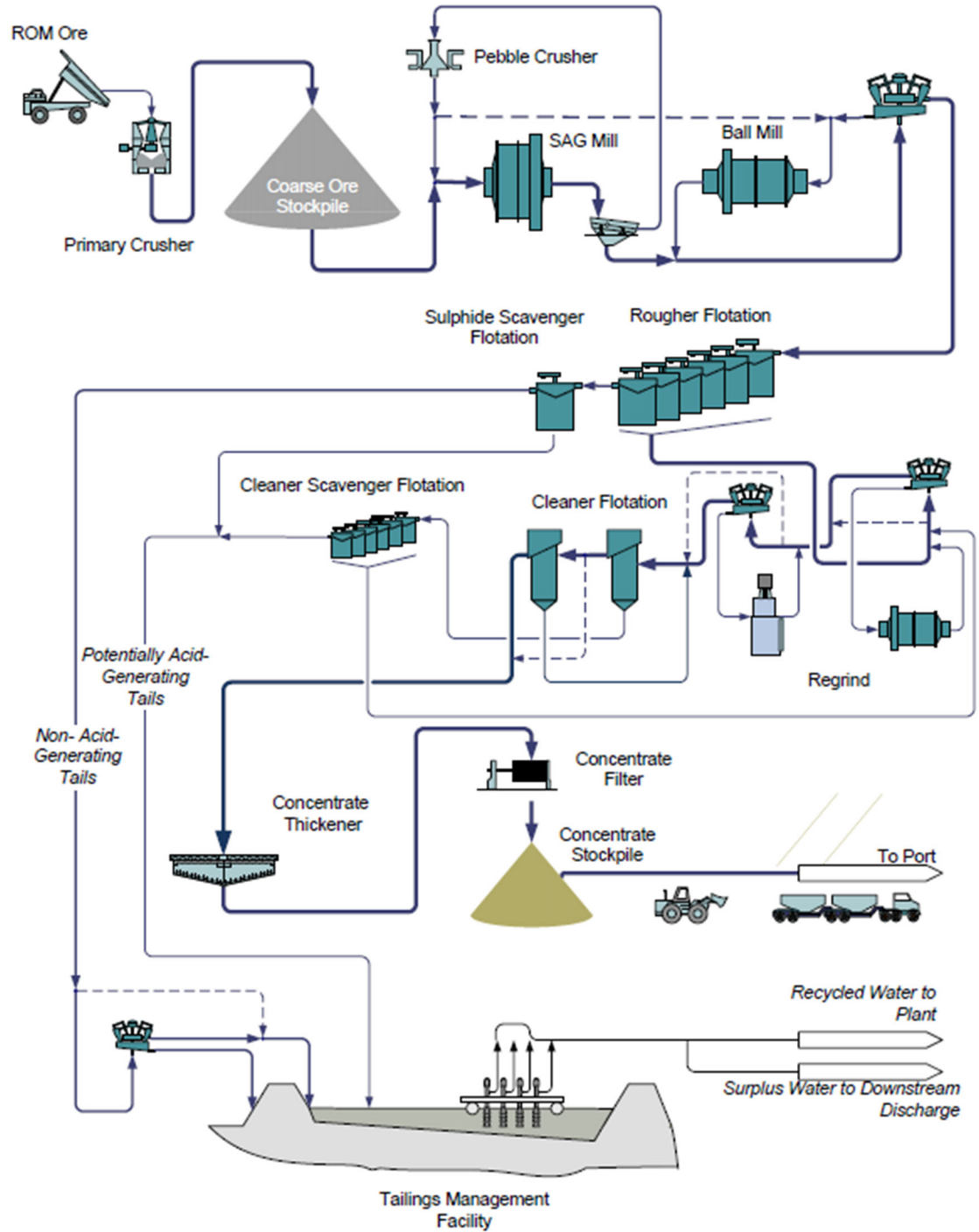

Note: Figure prepared by Newcrest, 2021.

Two process options were evaluated:

- A Central Case (that forms the base case), that would treat 13.6 Mt/a of underground ore through the existing SABC circuit plus a new single-stage SAG mill circuit; this concept was within the current maximum permitted throughput of 38,000 t/d average, 13.87 Mt/a;
- An Upside Case (that forms an alternative case), that would treat 15 Mt/a of underground ore through the existing SABC circuit plus a new single-stage SAG mill circuit, with SAG mill discharge configurations modified to allow coarsening of grind size, and addition of a HydroFloat coarse particle flotation circuit.

In both cases, flotation and concentrate dewatering upgrades were included to allow processing of higher head grade underground ore.

17.4 Central Case

17.4.1 Background

The Central Case (base case) expansion aimed to increase the throughput of the process plant from the current 11.0 Mt/a treating open pit ore to 13.6 Mt/a treating underground ore. The underground ore is harder and has higher copper and gold head grades. In the Central Case the target grind size aimed to revert to the original Red Chris design of 80% passing 150 μm .

The Central Case expansion largely kept the existing process operation, added an additional grinding line and expanded some unit operations to suit block cave ore. Upgrades include a new coarse ore stockpile, single-stage SAG mill, pre-rougher StackCells, new regrind circuit and expansion of the concentrate dewatering circuit. The ore properties of underground ore are expected to be sufficiently favourable to discontinue sulphide scavenger flotation, which is required for most open pit ores. The existing regrind ball mill would be removed to create space for an expanded cleaner flotation circuit. A single, large vertical stirred regrind mill (HIG mill technology) is proposed to make up for the loss of the capacity from the decommissioned regrind ball mill. The expansion scenario considered that the ongoing process improvement projects would be online prior to the block cave expansion, including Cleaner Column 3, Phase 1 pre-rougher StackCells (treating cyclone overflow from the existing SABC circuit), and NAG tailings thickening.

17.4.2 Plant Design

The existing SABC comminution circuit will operate independently from the expansion single-stage SAG comminution circuit. These two circuits will incorporate independent pre-roughing StackCells on the products from the respective grinding circuits. The tailings from these two pre-rougher circuits are then combined into the existing rougher flotation circuit. Upgrade equipment in regrinding, cleaner flotation, and concentrate dewatering circuits will generally be integrated with the existing equipment.

A new coarse ore stockpile (COS) will be required for the expansion. The new COS will be covered to reduce dust emissions; the 2021 PFS envisaged a partial conical cover. The stockpile reclaim system will mirror the existing system with two operating apron feeders drawing crushed ore onto the single-stage SAG feed conveyor, and a third apron feeder as a standby.

Ore from underground will feed onto the existing COS via a transfer conveyor to the existing overland conveyor and onto the new COS via a new COS feed conveyor. A diversion system will partition ore between the two conveyors.

The single-stage SAG feed conveyor will feed both fresh feed and recycled pebbles to a new single-stage SAG mill. The product from the mill will discharge onto a single-stage SAG discharge vibrating screen, which separates oversize from undersize material. Oversize pebbles will recirculate using a series of conveyors to a pebble bin. For the Central Case, a future option is to install a pebble crusher; however, the pebble crusher itself was removed during value engineering. A belt feeder will draw pebbles from the bin and through transfer chutes onto the single-stage SAG feed conveyor. A provision exists to divert pebbles out of the circuit to a temporary stockpile when treating hard ore or if there are process instabilities (e.g., grate damage in single-stage SAG mill). Stockpiled pebbles can be returned to the circuit via a loading chute adjacent the pebble crusher building.

Vibrating screen undersize will discharge into a cyclone feed pumpbox where it will be pumped to a cluster of cyclones. Cyclone underflow (oversize material) will flow back via gravity into the single-stage SAG mill for additional grinding. Cyclone overflow will discharge into a pumpbox where it will be pumped to the new single-stage SAG pre-rougher StackCells.

Grinding media will be added periodically using ball buckets for the SAG mill. A ball bunker has been incorporated into the design.

The new single-stage SAG mill will have twin pinions and synchronous motors of 8,250 kW each. Variable frequency drives (VFDs) will be incorporated to control mill speed. The existing SABC circuit will continue to operate in the current configuration. No modifications are anticipated for the SABC circuit for the Central Case.

The existing Red Chris rougher flotation circuit consists of up to seven tank cells. In 2022 the operations are planning to install two new pre-rougher StackCells to treat the product from the existing single-stage SAG circuit (Phase 1). The block cave process plant expansion will then add two more StackCells to process the product from the single-stage SAG grinding circuit. These StackCells are considered to be Phase 2 of the StackCell installations, and are referred to as the single-stage SAG StackCells. Tailings from Phase 1 and Phase 2 pre-rougher StackCells will be combined and fed to the existing rougher flotation bank.

A new metallurgical sampler will be installed on the feed to the single-stage SAG StackCells. The tailings from the single-stage SAG StackCells will flow via gravity to the existing rougher flotation feedbox. The SABC StackCells tailings will also flow via gravity to the existing rougher flotation feedbox. Rougher flotation tailings will exit via the

existing 7th rougher flotation cell and will continue to discharge into the NAG trench where the tailings will be transported to the TIA. The SABC StackCell concentrate will discharge via gravity into the existing rougher flotation concentrate pumpbox for regrinding. The single-stage SAG StackCell concentrate will discharge via gravity into the regrind cyclone feed pumpbox for regrinding and subsequent cleaning.

Reagents, including IPETC, PAX, and MIBC, will be dosed as required for the rougher flotation circuit.

Rougher flotation concentrate will require regrinding to increase liberation and allow upgrading in the cleaner circuit to saleable concentrate grades at high cleaner stage recovery. The SABC StackCell and existing rougher flotation concentrate will be pumped into the regrind cyclone feed pumpbox where it will join the single-stage SAG StackCell concentrate and existing cleaner scavenger flotation concentrate. The combined regrind circuit feed will be pumped into an open circuit regrind cyclone cluster. Cyclone underflow (oversize material) will discharge into HIG mill feed pumpbox. The HIG mill feed pumpbox will pump concentrate into a new HIG3500 regrind mill. The HIG mill discharge will overflow into a media retention screen with screen underflow discharging into the HIG mill product pumpbox where it will join regrind cyclone overflow.

An automated HIG mill media addition system will be installed to regulate media feed into the HIG mill. The new HIG mill will be installed with a VFD to control speed and allow for optimization.

HIG mill product will be pumped to a new Jameson cell, which will operate in a cleaner-scalper duty. The product from the Jameson cell will report to final concentrate, and tailings will be pumped to the existing cleaner circuit. The existing cleaner circuit will operate with two stages of columns in series. The first stage will use Cleaner Column 1. Column 1 concentrate will feed Cleaner Column 3. Cleaner Column 3 concentrate will be combined with Jameson cell concentrate in the Jameson cell concentrate pumpbox prior to transport to the upgrade concentrate dewatering circuit. Cleaner Column 3 tailings will be pumped back to Cleaner Column 1. Cleaner Column 1 tailings will be pumped to the existing cleaner scavenger flotation circuit. Cleaner scavenger flotation concentrate will report to the HIG mill circuit for regrinding. Cleaner scavenger tailings will discharge into the existing PAG trench where it will discharge via gravity to the PAG deposition zone in the TIA.

The existing primary regrind ball mill will no longer be used and will be demolished to make room for the Jameson cell. The existing regrind Vertimill VTM1500 will be retained in a standby capacity for the Central Case. It will be used in the Upside Case for regrinding of HydroFloat concentrate.

Flowsheet simulations indicated that there will be sufficient capacity to process spot surges in head grades from the block cave, if required when compared against industry standards for copper column flotation of 2.5 t/hr/m² for copper cleaner column flotation.

Due to the increase in throughput and copper head grade with the block cave plant upgrade, concentrate production will increase significantly compared with block cave operations. Therefore, a significant increase in concentrate dewatering capacity is

required, both thickening, storage tanks and filtration. The final concentrate from the cleaning circuit will be split between two parallel concentrate thickeners; the first being the existing concentrate thickener and the second a new thickener of equivalent size installed as part of the block cave upgrade. The new concentrate thickener is required to accommodate the extra concentrate production resulting from the increased head grade and throughput.

Concentrate thickener underflow will be pumped to and split between two concentrate storage tanks of equal size; the first is the existing concentrate storage tank and the second will be a new tank installed for the block cave upgrade. The storage tanks, which serve as a buffer between the flotation operation and the filters, will have overall concentrate storage retention time of 24 hours.

Concentrate from the storage tanks will be split and pumped into one of two parallel, identical concentrate filters; one existing and one new. The concentrate filters discharge concentrate onto conveyors which discharge into the concentrate shed. Additional concentrate filtrate tanks and pumps will be required for the new filter.

The concentrate storage shed will be expanded to accommodate the additional concentrate production.

17.4.3 Process Flowsheet

The proposed process flowsheet for the Central Case is included as Figure 17-2.

The layout plan for the Central Case plant design is provided in Figure 17-3.

17.4.4 Design Criteria

The plant design criteria for the Central Case is provided in Table 17-1.

17.5 Upside Case Alternative

17.5.1 Background

The Upside Case for the block cave process plant upgrade was an extension of the Central Case, and assumed HydroFloat coarse particle flotation and an increase in grind size at a higher throughput rate. The concept included:

- In the single-stage SAG circuit the pebble crusher will be installed in the transfer building included in the Central Case;
- The discharge and screen configurations of the SAG mills and hydrocyclone components will be modified to allow coarsening of grind size;
- A HydroFloat circuit will be installed on rougher tailings after classification;
- HydroFloat concentrate will be reground in a re-configured Vertimill VTM1500;

Figure 17-2: Central Case Proposed Flowsheet

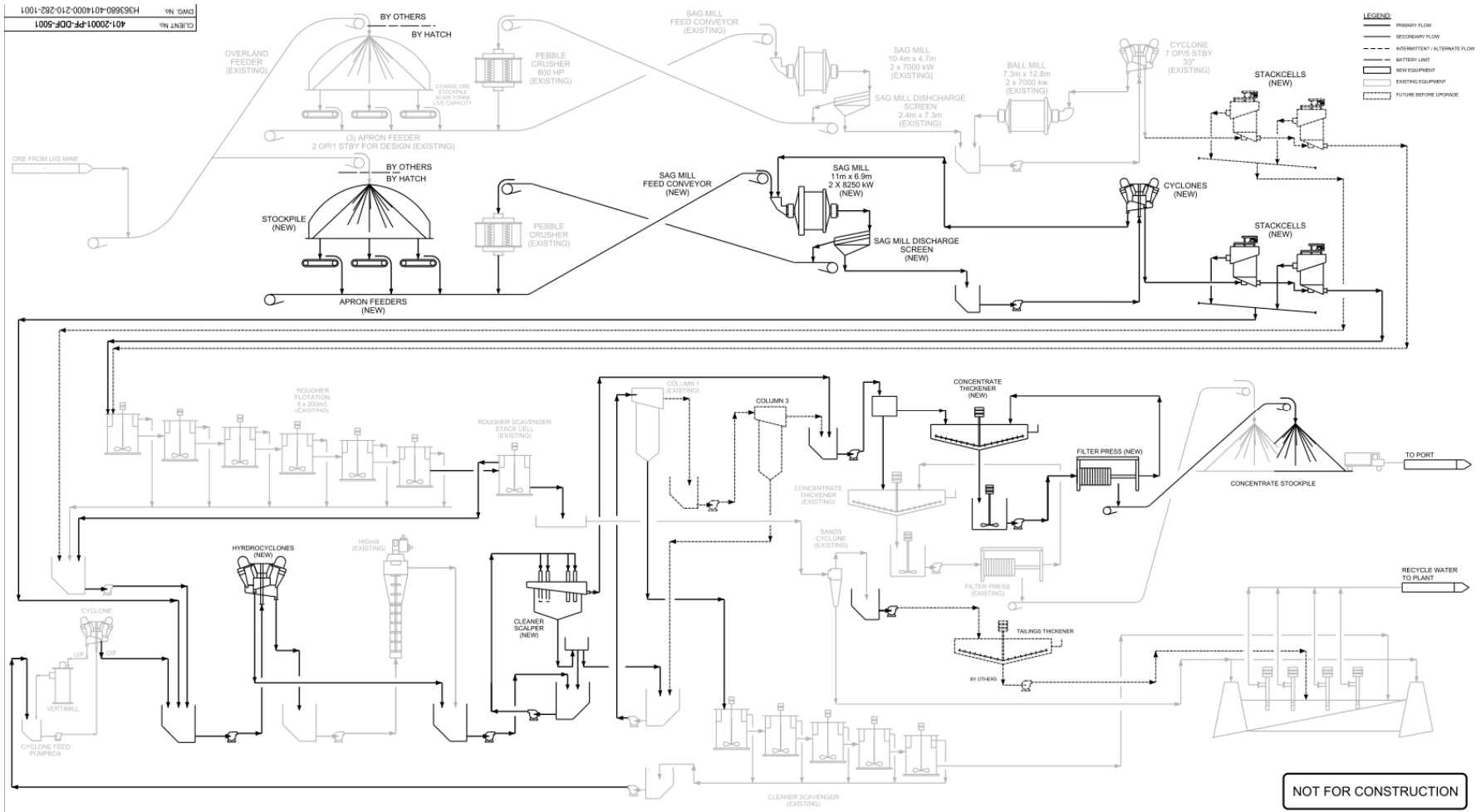

Note: Figure prepared by Newcrest, 2021.

Figure 17-3: Process Plant Layout Incorporating Block Cave Upgrade

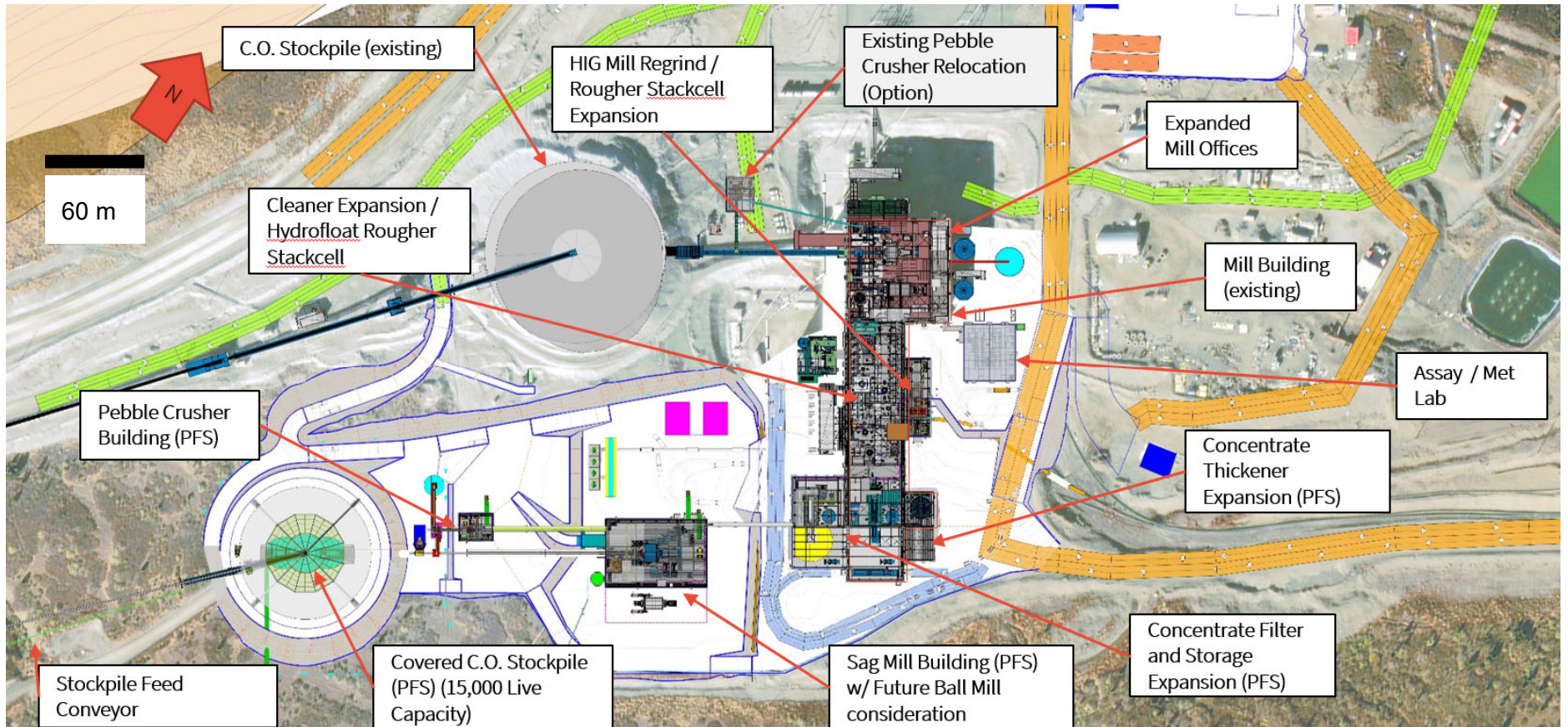

Note: Figure prepared by Newcrest, 2021.

Table 17-1: Design Criteria, Central Case

Criteria	Unit	SABC	Single-Stage SAG	Combined
<i>Ore Properties</i>				
Annual Throughput (per grinding circuit)	Mt/a	8.5	5.1	13.6
Annual concentrate production, average	t/a			394,400
Daily concentrate production, average	t/d			1,081
Copper head grade	%			0.72
Gold head grade	g/t			1.04
Ore specific gravity, solids	—			2.76
<i>Comminution</i>				
Coarse Ore Storage Capacity (live)	t	30,000	15,000	
Mill availability	%			91
Grinding feed size, F ₈₀	mm			102
Feed fines content (% feed under 15 mm)	%			35
Final product size, P ₈₀	µm			150
<i>Grinding Circuit</i>				
Number of SAG mills	#	1	1	
Mill dimensions (diam. x effective grinding length)	ft	34 x 13.5	36 x 22.5	
Installed motor power	kW	14,000 (two x 7,000 kW)	16,500 (two x 8,250 kW)	
Pebble (cone) crusher model	—	HP800	HP900 (or equivalent)	
Number of ball mills	—	1		
Ball mill dimensions (diam. x length)	ft	24 x 42		
Installed ball mill motor power	kW	14,000 (dual pinion, VFD)		
Number of cyclone clusters	#	1	1	
Number of cyclones per cluster	#	12	8	
<i>Rougher Flotation</i>				
Total rougher circuit mass pull	%			15

Criteria	Unit	SABC	Single-Stage SAG	Combined
StackCell effective volume scale-up factor	—			4
Number of StackCells per bank	—	2	2	
Actual flotation cell volume (StackCell)	m ³	75	75	
Number of cells in existing rougher bank	—			7
Existing conventional flotation cell size	m ³			200/160
Total cell volume	m ³			1,360
Calculated total retention time (effective)	minutes	28.0	35.0	
<i>Regrind Circuit</i>				
Product size p ₈₀	µm			30
Mill type	—			HIG3500
Installed power/operating power	kW			3,500/3,270
<i>Cleaner Flotation</i>				
Cleaner scalper cell type	—			1 x Jameson cell
Jameson cell model				B64500/24
Existing cleaner column cell type	—			Column
Total number of columns	—			2
Column dimension (diam x height)	m			4.6 x 14.0
Number of cleaner scavenger flotation banks	—			1
Number of cells in cleaner scavenger	-			5
Cleaner scavenger flotation cell size	m ³			50
<i>Concentrate Thickening</i>				
Number and thickener type	—			2 x Hi-Rate
Concentrate thickener diameter	m			13.0
<i>Concentrate Filters</i>				
Unit type	—			2 x pressure
Model type	—			MCDAC-H1500X58
Number of filters	—			2.0
Solid throughput	t/h			49.5

Criteria	Unit	SABC	Single-Stage SAG	Combined
<i>Concentrate Load-out</i>				
Final concentrate moisture	%wt			10
Final concentrate bulk density	t/m ³			N/A
Concentrate stockpile live storage capacity (total)	days			6
Concentrate load-out method	—			Front-end loader

- Reground HydroFloat concentrate will be upgraded in a new HydroFloat rougher flotation stage that will incorporate smaller StackCells, than the ones nominated for pre-roughing duty, and the HydroFloat rougher concentrate will be blended with the existing rougher concentrate streams to feed the cleaner flotation circuit.

The Upside Case assumes that the maximum permitted throughput can be increased, sufficient make-up water can be provided to sustain the higher production rate, and the economics of the expansion to the Upside Case can be confirmed to be favourable.

17.5.2 Plant Design

The descriptions for the Central Case provided in Section 17.4 generally apply to the Upside Case; however, the following changes are envisaged in the Upside Case.

Rougher tailings will flow by gravity to the sand cyclones. The sand cyclone underflow will discharge via gravity to the HydroFloat circuit. The sand cyclone overflow will go to the fines thickener for water recovery. The HydroFloat tailings will meet sand quality requirements and report to the TIA for use in embankment construction at the north and south dams (see also Section 18.5 and Section 18.6). The HydroFloat concentrate will be dewatered using cyclones to control density and volume flow in the subsequent regrind and flotation steps. The cyclone overflow will primarily contain low value slimes and water and will enter into the fines thickener for water recovery.

For the Upside Case it is assumed that the full regrind needs of the rougher and cleaner scavenger concentrates will be met by a new HIG mill 5000 installation, which will be part of the plant upgrade. This will free up the existing Vertimill VTM1500 to be redeployed for regrinding dewatered HydroFloat concentrate.

The VTM1500 product will go to a HydroFloat upgrade flotation circuit. The HydroFloat upgrade flotation circuit will consist of StackCells to upgrade the HydroFloat concentrate. The HydroFloat circuit flotation tailings will flow by gravity to the existing NAG trench. The HydroFloat circuit flotation concentrate will be pumped to the HIG5000 for regrinding. At this point, the HydroFloat circuit concentrate will enter into the existing cleaner circuit where it will be upgraded to the final concentrate.

17.5.3 Process Flowsheet

The process flowsheet envisaged for the Upside Case is included as Figure 17-4.

17.5.4 Design Criteria

The plant design criteria for the Upside Case is provided in Table 17-2.

Figure 17-4: Upside Case Proposed Flowsheet

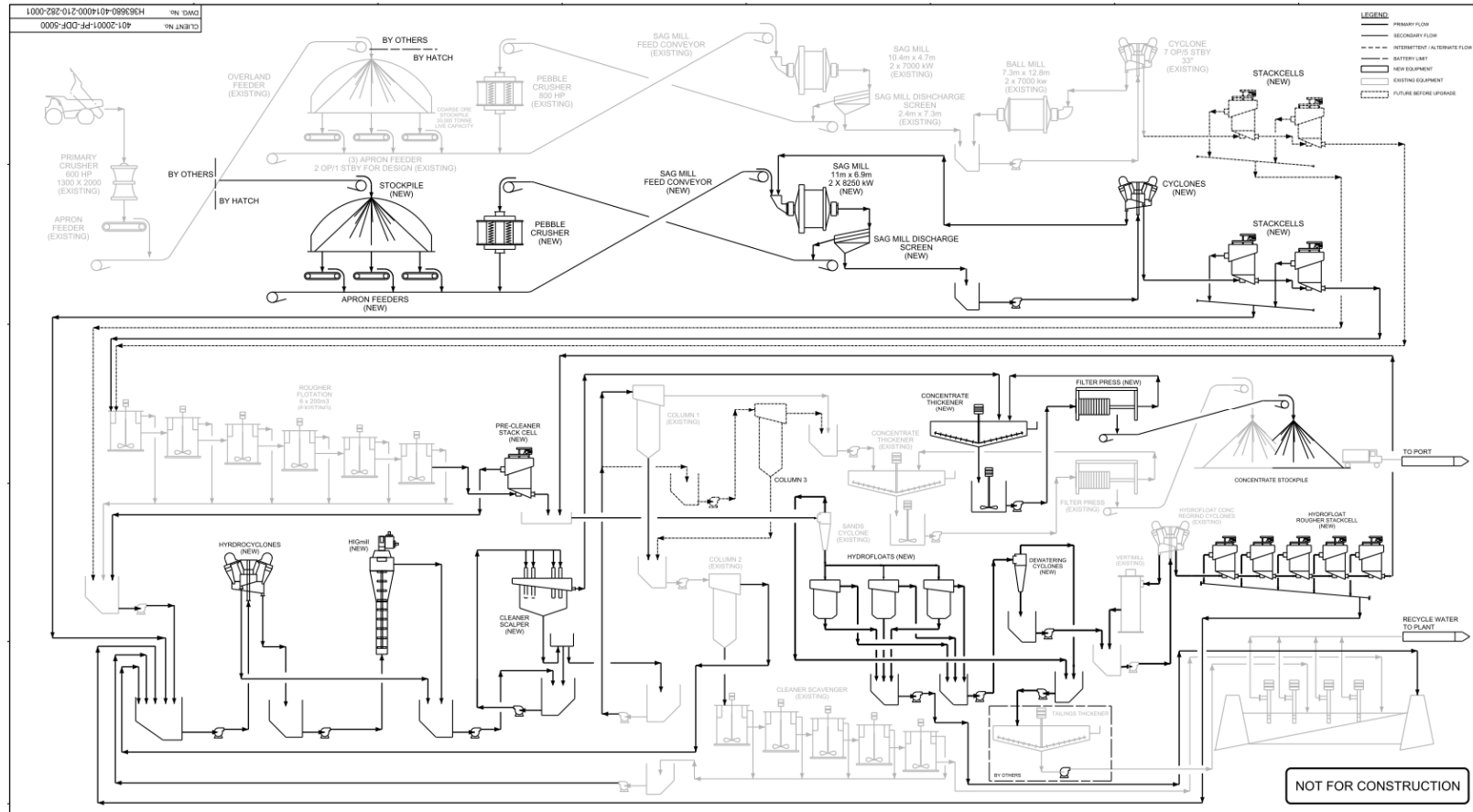

Note: Figure prepared by Newcrest, 2021.

Table 17-2: Design Criteria, Upside Case

Criteria	Units	SABC	SSAG	Combined
<i>Ore Properties</i>				
Annual throughput (per grinding circuit)	Mt/a	9.4	5.6	15.0
Annual concentrate production, average	t/a			435,000
Daily concentrate production, average	t/d			1,192
Copper head grade	%			0.72
Gold head grade	g/t			1.04
Ore specific gravity, solids	—			2.76
<i>Comminution</i>				
Coarse ore storage capacity (Live)	t	30,000	15,000	
Mill availability	%			91
Grinding feed size, F ₈₀	mm			102
Feed fines content (% feed under 15mm)	%			35
Final product size, P ₈₀	µm			200
<i>Grinding Circuit</i>				
Number of SAG mills	#	1	1	
Mill dimensions (diam. x effective grinding length)	ft	34 x 13.5	36 x 22.5	
Installed motor power	kW	14,000 (two x 7,000)	16,500 (two x 8,250)	
Pebble (cone) crusher model	—	HP800	HP900	
Number of ball mills	—	1		
Ball mill dimensions (diam. x length)	ft	24 x 42		
Installed ball mill motor power	kW	14,000 (dual pinion, VFD)		
Number of cyclone clusters	#	1	1	
Number of cyclones per cluster	#	12	8	
<i>Rougher Flotation</i>				
Total rougher circuit mass pull	%			15

Criteria	Units	SABC	SSAG	Combined
StackCell Eff. volume scale-up factor	—			4
Number of StackCells per bank	—	2	2	
Actual flotation cell volume (StackCell)	m ³	75	75	
Number of cells in existing rougher bank	—			7
Existing Conventional Flotation Cell Size	m ³			200/160
Total cell volume	m ³			1,360
Calculated total retention time (effective)	minutes	25.0	33.0	
<i>Regrind Circuit</i>				
Product size P ₈₀	µm			30
Mill type	—			HIG5000
Installed power/operating power	kW			5,000/4,063
<i>Cleaner Flotation</i>				
Cleaner scalper cell type	—			1 x Jameson cell
Jameson cell model				B64500/24
Existing cleaner column cell type	—			Column
Total number of columns	—			2
Column dimension (diam. x height)	m			4.6 x 14.0
Number of cleaner scav. flotation banks	—			1
Number of cells in cleaner scavenger	—			5
Cleaner scavenger flotation cell size	m ³			50
<i>Concentrate Thickening</i>				
Number and thickener type	—			2 x Hi-Rate
Concentrate thickener diameter	m			13.0
<i>Concentrate Filters</i>				
Unit type	—			2 x Pressure
Model type	—			MCDAC-H1500X58
Number of filters	—			2.0
Solid throughput	t/h			54.6

Criteria	Units	SABC	SSAG	Combined
<i>HydroFloat</i>				
Feed solids density	w/w			65
No. of HydroFloat cells	—			3
Diameter	m			3.7
<i>HydroFloat Concentrate Regrind</i>				
Number of mills & type	—			1 x VTM1500
Installed power/operating power	kW			1,119/951
Circuit regrind size	um			106
<i>HydroFloat Upgrade Flotation</i>				
Number of StackCells and StackCell size	m ³			5 x 10 m ³
Total retention time	minutes			20

Note: SSAG = single-stage SAG circuit

17.6 Concentrate Shipping

Red Chris concentrate is filtered and temporarily stored in the Red Chris concentrate storage shed at the mine before being trucked to the Port of Stewart. Concentrate is dumped from the side tipper tables into the warehouse for storage, handling, and loading via conveyor and spout into export vessels. There are currently no seasonal payload restrictions on the route between the mine site and the port.

The Red Chris Operations have had a Terminal Services Agreement in place with Stewart Bulk Terminals since 2013. The term of the agreement is for the LOM.

Stewart Bulk Terminals is a privately-owned facility not subject to underlying lease agreements with the government port authorities, and is the most commercially and logistically suitable port for Red Chris concentrates.

The 2021 PFS assumes the current transport method and port will continue to be used.

17.7 Energy, Water, and Process Materials Requirements

17.7.1 Energy

Current and planned power and electrical requirements for the LOM plan are outlined in Section 18.11.

17.7.2 Water

The source of process water supply for the LOM plan is discussed in Section 18.6.

17.7.3 Process Consumables

Key processing reagents include collectors, frother, lime, and flocculant with other key materials being mill grinding media. The reagents envisaged are similar for the Central and Upside Cases. The HydroFloat in the Upside Case will require a minor quantity of diesel collector.

The site has suitable reagent handling and storage facilities for these items, with all materials transported to site via road transport. Modest increases in the capacity of the reagent systems will be required for the block cave project.

17.8 QP Comments on “Item 17: Recovery Methods”

The QP notes:

- The most suitable option compatible with a major investment in a block cave mine was found to be the installation of a large single stage SAG mill, coupled with a new coarse ore stockpile, to allow an increase in throughput to 13.6 Mt/a in the Central Case option, which is within the currently permitted throughput limit;

- The Central Case also requires additional rougher flotation capacity at the existing process plant using StackCell technology, an upgraded regrind circuit using HIGmill technology, a new cleaner scalping Jameson Cell, and duplication of existing concentrate thickening and filtration equipment. The concentrate loadout will also be expanded. The cleaner flotation, concentrate dewatering and concentrate loadout upgrades are required due to the higher head grade of underground ore compared with open pit ore;
- Throughput could be increased to 15 Mt/a by reconfiguring both the existing and new SAG mills to coarsen grind from 80% passing (p_{80}) 150 μm to 200 μm and installing coarse particle flotation using HydroFloat technology.

18 PROJECT INFRASTRUCTURE

18.1 Introduction

Existing mine infrastructure includes:

- Open pit;
- One coarse ore stockpile and one low-grade stockpile;
- One WRSF;
- TIA;
- North and the south reclaim dams;
- Non-contact water diversion structures;
- Overhead high voltage electric transmission line;
- Process plant, process facilities; mine laboratory, offices;
- Warehouse;
- Potable water and sewage treatment plants;
- Camp with kitchen and recreational facilities;
- Administration office building;
- Core storage facility;
- Maintenance workshop and truck wash;
- Medical and ambulance facilities;
- Operations facility;
- Fuel storage and distribution.

The transition to block cave mining and associated changes to processing will be supported by existing infrastructure as well as infrastructure upgrades.

Infrastructure upgrades that have recently been completed or are currently in progress for ongoing open pit operations, and will be integrated with the block cave project, are as follows:

- New mobile equipment maintenance and workshop facility;
- Pumping upgrade from the North Reclaim dam to the booster station;
- Seepage mitigation modifications for the TIA;
- New cyclone sand plants and tailings thickener for dewatering NAG tailings cyclone overflow;

- Associated modifications to tailings pipelines for the cyclone sand plants, thickeners, and short term tailings deposition;
- Dust cover for the existing coarse ore stockpile;
- Kitchen and camp upgrades to support the existing open pit operation.

Newcrest plans to implement, or is already implementing, an early-works program in support of the block cave project; which incorporates the following components:

- Exploration decline;
- Water supply and storage;
- Road access;
- Power supply;
- Short-term stockpile areas;
- Buildings (administration, workshop, mine dry);
- Batch plant;
- Exploration decline dewatering system.

The main changes to surface infrastructure to support the block cave project include the following:

- A significant increase in the power supply to site to 110 MVa;
- Power supply and distribution (including 287 kV substation expansion, upgrades to existing 25 kV distribution system, and a new mine 25 kV substation);
- An increase in the size of the TIA will be required to develop MB2 and MB3;
- Increases in water supply to support higher ore processing rates in conjunction with additional tailings dewatering for water recovery and TIA changes to reduce seepage potential;
- TIA seepage water return system;
- Potable water and sewage services;
- Communications systems;
- Fuel storage and distribution;
- Storm water management;
- New operations accommodation complex;
- New mine dry facility;
- New site asset operations complex (SAOC) and administrative complex;
- New shotcrete and concrete batch plant;

- New diesel drop pipe facility on the surface distributing fuel to the underground fleet;
- Temporary construction facilities, including laydown areas
- Truck wash relocation.
- New site roads to allow access to the WRSFs, conveyor portal, exploration access portal, ventilation shafts, reclaim dams at the TIA, tailings lines, TIA dams, and to runoff diversion ditches;
- Increase in the volume of concentrate transport to the Port of Stewart that will require additional road maintenance and upgrades to roads and port facilities.

The new infrastructure requirements are summarized in Table 18-1. A location plan that shows the locations of the existing and proposed infrastructure is provided in Figure 18-1.

18.2 Road and Logistics

18.2.1 Roads

The mine site is accessible by a 23 km sealed access road that connects with Highway 37 at Tatogga (mine site entrance off Highway 37). Highway 37 connects to Dease Lake, 95 km by road to the north. The mine security gate is at the junction of Highway 37 and the start of the site access road. Internal roads within the mine site are gravel surface.

There will be new haul roads and site roads to allow access to the various locations, including the TIA, conveyor portal area, exploration portal, ventilation pads and reclaim dams at the TIA. Service roads will also be constructed alongside pipelines and diversion ditches.

Existing roadways around the process plant will be modified and re-graded to suit the new facilities, with some of the existing roads requiring widening and resurfacing.

18.2.2 Logistics

Concentrate is transported 320 km from the mine south to the Stewart Bulk Terminals at the Port of Stewart. Concentrate is stored in sheds at the bulk terminal until there is a sufficient stockpile to ship load.

The current philosophy of shipping concentrate through the Stewart Bulk Terminals will be maintained for the block cave project.

18.3 Stockpiles

Stockpiles are discussed in Section 16.2.6.

Table 18-1: Surface Infrastructure Required in 2021 PFS to Support Block Cave Mining Operation

Type	New Surface Infrastructure
Buildings	Operations accommodation complex (OAC), site asset operation centre (SAOC), mine dry, concrete/shotcrete batch plant.
Water	Expansion of existing North dam and South dam, new Northeast dam, relocated North Reclaim dam and South Reclaim dam, new Northeast Reclaim dam. North Valley pumping wells, North Valley seepage wells, make-up water booster pumps and pipelines for fresh and reclaim water, potable water treatment plant (PWTP), fire water supply to OAC, decline conveyor.
Fuel	Propane, diesel storage and distribution.
Compressed air	Air compressors to supply compressed air to underground utility stations.
Waste handling	Sewage treatment plant (STP), septic field.
Storm water drainage	Ditches around the OAC.
Power	Expansions to switchgear and substations, mine substation, site-wide reticulation.
Communications	Communications backbone feeding surface and underground facilities.
Site roads	Surface haul roads, access to conveyor portal, ventilation raises, process plant, TIA dam access roads.
Temporary facilities	Laydown areas, construction offices, warehouse, maintenance shops, water utility supply pump/pipeline from south reclaim pond.
Civil works	Stockpile pads, TIA reclaim dam diversion ditches, Camp Creek diversion, and Beaver Creek diversion (around OAC).

Figure 18-1: Infrastructure Location Plan

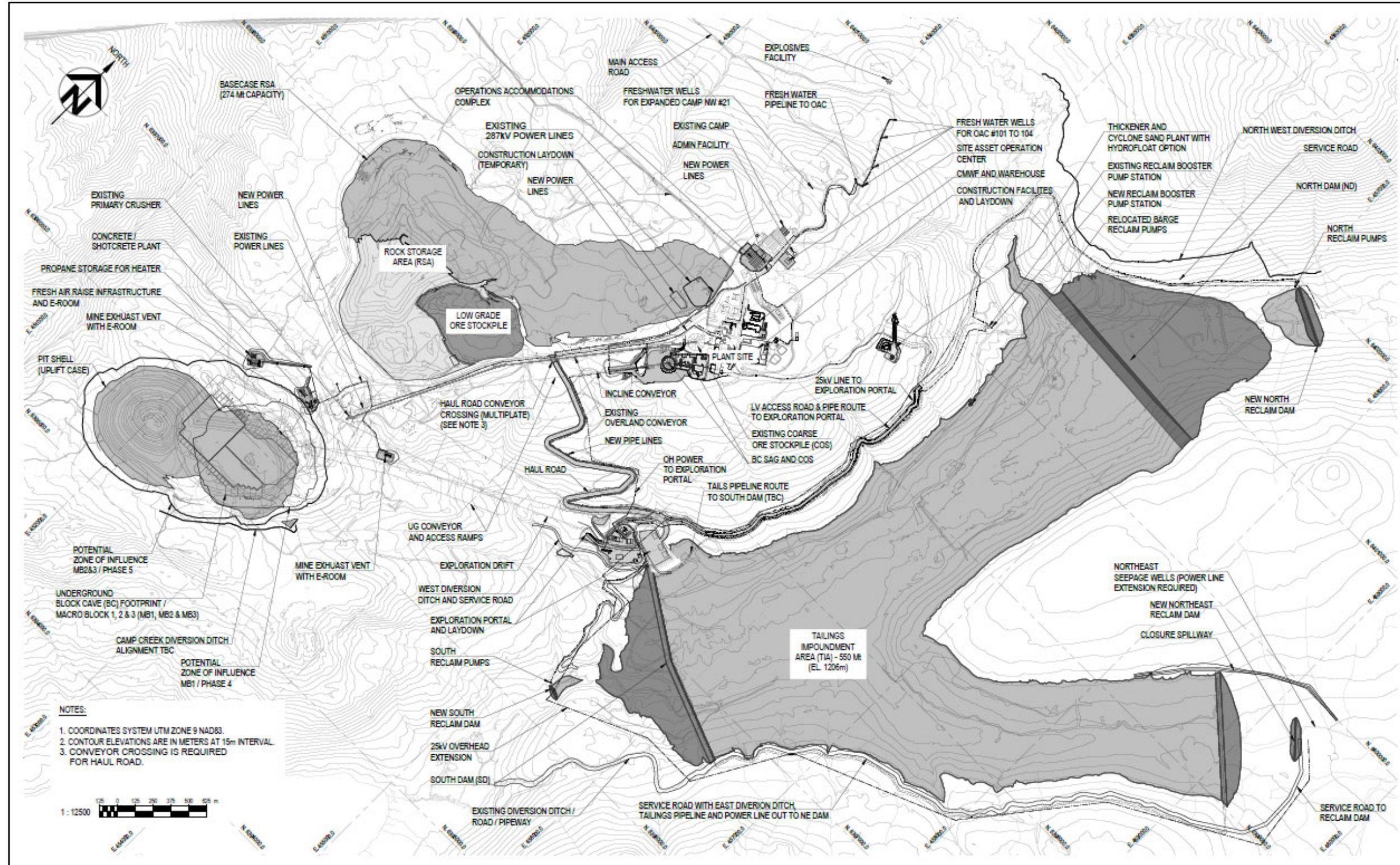

Note: Figure prepared by Newcrest, 2021.

18.4 Waste Rock Storage Facilities

The WRSF is discussed in Section 16.2.7.

18.5 Tailings Storage Facilities

18.5.1 Existing Facility

The TIA is currently permitted for 302 Mt of tailings, the containment of which is provided by a single impoundment with natural topography, and the LOM design incorporates three dams, the North, South, and Northeast dams, to a final elevation of 1,180 m.

The North and South dams are operational, and raised using the centreline method as needed; the Northeast dam is planned for approximately Year 21 of the 2021 PEA mine plan (circa 2036). The North and South dams have been in operation since February 2015 when deposition began in the North Valley impoundment. Deposition in the South Valley impoundment began in July 2017.

The North and South dams are designed to be predominantly constructed using cyclone sands. This is to minimize the requirements for borrow materials, which are in relatively limited supply. Extraction of such borrow materials in quantities required for complete dam construction would cause significant environmental impacts and would dramatically increase dam construction costs. The M-240 permit specifies that cyclone sands must meet NAG criteria (NPR > 2) if used for dam construction. The Northeast dam would be constructed predominantly using rockfill.

The current mine permit requires the segregation and separate deposition of NAG and PAG tailings. PAG tailings consist of cleaner–scavenger tailings and sulphide scavenger concentrate when the sulphide scavenger stage is in operation. PAG tailings are required to be separately disposed of in the TIA and maintained in a saturated area (this is a permit condition). NAG tailings can either be deposited whole into the impoundment or cycloned to produce a cyclone sand product used for embankment construction.

Currently cyclone overflow is placed in sand cells, either on the upstream side of the North dam or along the northwestern shoreline of the TIA for recovery and placement on the North dam. Generally, sands are not placed into the impoundment, although some sand may enter the impoundment as a result of handling practices. NAG cyclone overflow is deposited in the impoundment (currently from the South dam).

There are two water reclaim dams located downstream of the North and South dams, referred to as the North and South Reclaim dams, respectively.

18.5.2 Setting

The TIA is located at the eastern edge of the mine site in a north–south-trending valley that has a major northeast tributary.

To the north, the North dam and North Reclaim dam are within the Quarry Creek catchment; to the south, the South dam and South Reclaim dam are within the Trail

Creek catchment. Quarry Creek flows north towards the Klappan River and Trail Creek flows south towards Kluea Lake.

The Red Chris site is located within an area of low historical seismicity. De-aggregation analysis performed by the Geological Survey of Canada shows that the peak ground acceleration hazard is primarily from two sources:

- Crustal area sources within about 300 km of the site;
- Plate boundary sources 420–560 km from site (e.g. the Queen Charlotte-Fairweather, Transition and Denali faults).

The mean estimated 1:10,000 annual exceedance probability (AEP) ground motion corresponds to a peak ground acceleration of 0.1 units of gravity and mean magnitude of 6.5.

Block-cave-induced seismicity has not been considered in the TIA design. A 2020 update of the seismic source model was completed by the National Research Council of Canada and is expected to be released in 2021. Both the updated seismic source model and the block-cave-induced seismicity will be considered in the next design stage.

Geohazard risks in the TIA area include:

- Two landslide features (approximately 0.1 m³ each) on the east side of the TIA valley with head scarps located approximately 500 m east of the north reclaim dam;
- A landslide complex (approximately 100 Mm³ on the eastern side of Kluea Lake approximately 4 km south of the south reclaim dam;
- The Kluea Lake Landslide Complex (KLLC), estimated to be approximately 400–800 Mm³, along the western slope of Kluea Lake.

The slope assessments on east and west sides of the TIA did not appear to show any significant risk of large-scale slope instability.

18.5.3 Facility Expansion

18.5.3.1 Designs

Facility designs were prepared by BGC Engineering, the Engineer of Record for the TIA.

To support the proposed block cave operation (including development of MB2 and MB3), the TIA will be expanded to a capacity of about 550 Mt. The design assumes raises on the north, south and northeast dams above that which is currently permitted, to a final elevation of 1,207 m.

As the North and South dams are raised, their footprint increases, requiring the decommissioning of the existing north and south reclaim dams. The 2021 PFS assumes decommissioning of the existing north and south reclaim dams and associated seepage interception systems, and reconstruction of those facilities further downstream; construction of a new Northeast Reclaim dam will also be required. Existing instrumentation and wells (monitoring and pumping) may need to be decommissioned

and new infrastructure installed. Existing water diversion channels or sections of existing channels will be decommissioned and new channels built around the expanded TIA to route contact water into the TIA and non-contact water away from the TIA.

The proposed TIA infrastructure is summarized in Table 18-2, and a layout map is provided in Figure 18-2.

The water management structures within the TIA were designed based on their failure consequence classification and regulatory requirements.

Stability analyses of the dams were completed using SLOPE/W, a commercially available limit equilibrium analysis software package. The 2021 PFS embankment designs meet Newcrest's requirements for factor of safety (FoS) for stability. For the north and south dams, the target FoS will be achieved through shallower slopes on the embankments. However, the shallower slopes will increase the volume of materials required to construct the dams. The higher embankments and shallower slopes will cause the North and South dam toes to migrate further down their respective valleys.

Based on the results of the pseudo-static analysis and Bray and Macedo (2019), the probability of seismic displacement equal to or larger than 150 cm due to the occurrence of the 1-in-10,000 year seismic ground motions is <1% for all dams.

The 2021 PFS design also assumes completion of two site improvement projects:

- Installation of a new cyclone sand plant treating NAG tailings;
- Installation of a new tailings thickener to process NAG cyclone overflow.

It is proposed to locate the cyclone sands plant and tailings thickener between the mill location on the Todagin plateau and the TIA valley, and construction completion is forecast for 2023.

Evaluations of greater TIA capacities were reviewed in the 2021 PFS, to 620 Mt and 800 Mt, and found to be conceptually achievable.

18.5.3.2 Closure Considerations

The closure configuration for the TIA included in the 2021 PFS is aligned with current permit conditions. A minimum 2 m water cover will be required over the PAG tailings zone and a closure spillway will be constructed at the northeast dam. Careful management of PAG tailings deposition will be required in the later part of the operation to ensure that the water cover requirements can be met. Alternative closure configurations will be investigated in future more detailed studies.

18.5.4 Tailings Deposition Plan and Dam Raise Schedule

Deposition modelling was completed using commercially-available Muk3D software and a five-year time increment. Modelling was aligned with design basis assumptions for tailings and sand production, beach slopes, deposition density, and maximum operational pond volume.

Table 18-2: TIA Expansion Designs

Facility	Note
North dam	Zoned earthfill and cyclone sand embankment constructed using the centre line construction method. This includes a 3 m thick chimney filter, which is designed to mitigate internal erosion and provide drainage. A minimum 100 m long upstream tailings beach is required. Underdrainage is provided by a coarse aggregate drainage layer between a sand and gravel filter.
South dam	Zoned earthfill and cyclone sand embankment constructed using the centre line construction method. The dam does not contain a core; therefore, the operating pond must be maintained at least 300 m upstream of the crest. A linear low-density polyethylene (LLDPE) liner was built up to El.1,118m on the upstream face of the dam and valley sides, extending 300m upstream from the upstream toe of the starter dam to limit seepage losses during initial filling. Designed with an underdrainage system, consisting of a coarse aggregate drainage blanket and a sand and gravel filter.
Northeast dam	Zoned earthfill embankment constructed using the centre line construction method. Will have a vertical compacted till core, filters, and an underdrainage system, as well as upstream and downstream rockfill support. A series of three 3 m wide chimney filters (fine filter, coarse filter, and transition filter) to be located directly downstream of the till core are designed to retain the core materials and provide drainage for seepage.
North, South and Northeast Reclaim dams	Located downstream of each tailings dam to collect impacted surface water, seepage exiting the underdrains, and seepage intercepted by the seepage interception system. Will be approximately 3–7m in height, and sized to contain the environmental design flood (spring 200-year, 24-hour rainfall and snowmelt) and pass the reclaim inflow design flood (200-year, 30-day rainfall and snowmelt) through a spillway. It is assumed that the new reclaim dams will be constructed near the end of the permitted LOM (approximately 2040–2043).
East, west, and northwest diversion ditches	<p>The east diversion ditch will divert non-contact water from the south side of the Northeast Valley and the east side of the South Valley to the lower reaches of Trail Creek, which ultimately discharges to Kluea Lake. The ditch is designed to reduce the volume of non-contact water flowing to the TIA and to augment the flow in lower Trail Creek.</p> <p>The west diversion ditch will divert contact water from Thurston’s Trickle and the west side of the South Valley and convey it to the TIA.</p> <p>The northwest diversion ditch will divert non-contact water from the west side of the North Valley to Camp Creek to reduce the volume of non-contact water flowing to the TIA.</p> <p>All ditches are sized for peak flows resulting from the 200-year, 24-hour storm event.</p>

Figure 18-2: TIA Infrastructure Layout Map

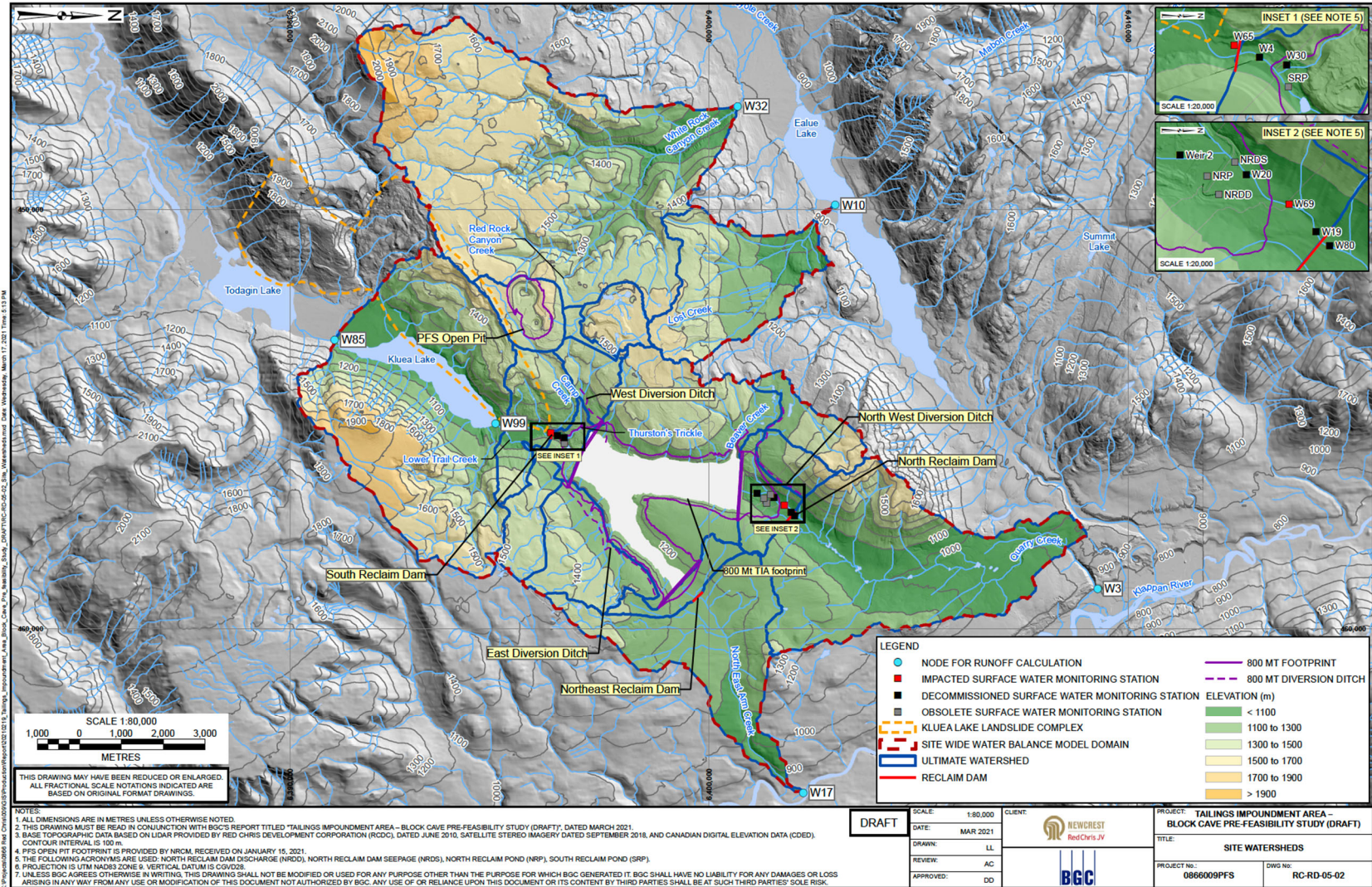

The pond was assumed to be migrated to a central location between the south and north dams prior to 2030 (a mid-way location was assumed for 2025). The model was iterated to target a central pond so that the PAG cleaner tailings remain saturated during operations and under a 2 m water cover at the end of LOM for closure.

A dam raise schedule and cyclone sands material balance was developed. The cumulative cyclone sand requirements (North and South dams) hit an inflection point around 2041. This reflects the flattening of the North dam slope as it is raised beyond the current permitted level, and the increased sand quantities required for further incremental raises. An inventory of sand must be built up before 2041 to provide sufficient material to build the final embankment heights.

18.5.5 Tailings Pipelines and Pumping

The current TIA has tailings pipelines to the following locations:

- NAG tailings pipeline from the NAG tailings trench at the process plant to the existing cyclone sand plant;
- NAG tailings bypass line from adjacent to the existing cyclone sand plant to the deposition point 300 m downstream of the South dam;
- Sand line from the cyclone sand plant to the sand cells on the upstream face of the North dam;
- Dedicated PAG tailings pipeline from the PAG tailings trench at the process plant to the deposition location near the centre of the TIA, where it can remain saturated.

Due to the significant elevation drop between the process plant and the existing cyclone sand plant, choke stations are installed on the NAG tailings pipeline to control pressure and flow.

As operations and tailings deposition continue, the height of the impoundment rises, which will eventually submerge several of the current tailings pipeline alignments, Newcrest has plans in place for modifications to the tailings piping, including:

- Connection of the NAG tailings pipeline from the NAG tailings trench to a new cyclone sand plant that will be located adjacent to the new tailings thickener;
- Deposition of the NAG cyclone overflow from the North dam for beach formation; this is anticipated to start in late 2022 when the tailings thickener is installed a new pipeline from the tailings thickener to the North dam will be required;
- A new smaller diameter pipeline from the thickener underflow to the South dam (smaller diameter is required due to the increased % solids and reduction in flow after thickening);
- New sand lines from the new cyclone sand plant to the North dam and from the new cyclone sand plant to the South dam.

In the longer term, a pipeline extension is also needed for the thickened NAG cyclone overflow from the South dam to the Northeast dam. Booster pumps will be required to

convey tailings approximately 4 km up the Northeast Valley. The estimated pumping power required is 1,300 kW, and the pipeline must be fully functioning by 2035.

18.6 Water Supply

18.6.1 Process Water Supply

The main source of water for the process plant is reclaim from the main pond at the TIA and, when constructed, will be from the planned thickener and cyclone sand plant. Other sources include seepage recovery from the north and south reclaim seepage ponds formed by the North Reclaim dam and South Reclaim dam, respectively. Groundwater pumping from the deep aquifer is the main source of makeup water when needed to meet process water demands.

The block cave project assumes the construction of the thickener and cyclone sand plant, and that the existing reclaim barge and booster station are adequate for the LOM.

A portion of the water from the process water tank will be used in the grinding and flotation circuits and the remaining water will be filtered using a screen filter package. Filtered water will be distributed to facilities around the site as utility water and will feed a fire water module for the process plant.

18.6.2 TIA

The TIA will be the main water management reservoir for the Red Chris Operations. Inputs to the TIA will include water from the tailings, runoff from the TIA catchment area, direct precipitation, and pump-back from the reclaim dams. Collected water from the pit and WRSFs, including the low-grade ore stockpile, will be initially routed through the mill for process use before reporting to the TIA with the tailings. Diversion ditches around the TIA will divert non-contact runoff water to the north and south of the TIA as much as practicable.

18.6.3 Reclaim Dams

The North and South Reclaim dams, located downstream of the main TIA dams, form ponds that collect runoff and groundwater seepage that reports to surface from the TIA. The reclaim ponds also serve as temporary reservoirs for groundwater pumped from the north and south valley TIA groundwater wells and from the south seepage interception system. Water collected in the reclaim ponds is currently pumped to the TIA, before being pumped to the process plant via the main reclaim pumping system, resulting in fresh make-up water from the deep aquifers being mixed with the general TIA reclaim water.

An on-site project is currently underway to modify this system to allow the water collected in the north reclaim pond to be pumped directly back to the filtered/fire water tank as clean make-up water. The same is planned for the south reclaim pond with water first pumped to the exploration portal for utility water and any excess pumped to the filtered/fire water tank at the plant.

Water from the north wells and North Reclaim dam may be used as process water for the underground block cave project.

18.6.4 Potable Water

There are three existing potable water systems in operation at Red Chris:

- Existing camp plus temporary expansion;
- Core storage facility, assay laboratory, administration;
- Heavy duty truckshop and warehouse.

Raw water is sourced from three groundwater wells, and treated through potable water treatment plants.

18.6.5 Water-Related Infrastructure

Water-related infrastructure for the Project includes: dewatering of the underground mine back to the existing process water tank at the process plant; assessment of the site-wide upgrades associated with the block cave project including the tailings pond and the reclaim water system upgrades; and determining the impact and updating the water supply and distribution system as required.

The North and South Reclaim dams at the TIA will be relocated and will require new pumping systems to transfer water to the process plant for re-use.

As part of the ongoing development of the open pit, Camp Creek will need to be diverted for about 700 m of its length around the southeastern side of the open pit to allow for the construction of a haul road. To address the potential zone of influence resulting from subsidence associated with the block cave project, Camp Creek will need to be diverted from a point further upstream for another 500 m. The ditch will be cut into the hillside, lined with riprap for erosion control, and will incorporate a service road for maintenance and servicing.

The infrastructure design includes new potable water and sewage treatment plants for the new accommodations and administration complexes, together with new groundwater wells and new water supply pipelines to ensure sufficient water supply.

Fire water and potable water will be supplied from a new potable water/fire water tank to the decline conveyor, exploration decline, and mine dries.

Drinking water will be supplied to the underground mine in the form of bottled water.

18.7 Water Management

Non-contact storm water runoff will be directed away from the TIA by the east diversion ditch (to Trail Creek) and northwest diversion ditch (from the Beaver Creek watershed to Quarry Creek).

Contact storm water runoff will report to the TIA via the west diversion ditch. No settling or sediment control will be required prior to discharge, and there will be no storm water

treatment or management infrastructure at the site for storm water runoff. Diversion ditches in the area around the new administrative and accommodations complexes will be designed for erosion control.

Dewatering flow from the open pit and storm water runoff from the WRSFs are directed to a local sump from where the water is pumped to the process plant for use in operations before reporting to the TIA as part of the tailings.

The 2021 PFS design allows for storing an operational inflow design flood (IDF) of 11.5 Mm³ while maintaining a 2 m freeboard. The IDF was derived from the estimated runoff from the 10-day probable maximum precipitation event coincident with the 1-in-100 annual exceedance probability 10-day snowmelt. The closure spillway is designed to safely route the closure IDF, which is based on runoff from the 24-hr probable maximum precipitation event with a 1-in-100 AEP annual exceedance probability snowmelt.

Excess impoundment water suitable for direct discharge will be pumped from the reclaim barge via a pipeline along the western flank of the TSF valley beyond the North dam and reclaim dam and allow discharge into the Quarry Creek system.

18.8 Buildings and Laydown Infrastructure

A new administrative complex, combining the SAOC and administrative offices, is planned. The SAOC will have dedicated operations rooms to manage and monitor the open pit, underground block cave development and operations, crushing and conveying systems, milling and process operations, TIA operations, and energy and water management facilities. It will also include central meeting/multi-functional coordination rooms.

A mine dry facilities capable of accommodating 500 miners will be constructed near the service portal to support mining operations. The overall facility will include a centrally-located common area that will accommodate the shifters' offices, lamp room, dispatch room, and additional mine rescue space to augment the existing mine rescue building that will be provided for the early works phase.

There is a general laydown area designated for the Project that will be shared between other projects and contractors working on the Red Chris site. The design allows for laydown areas that will accommodate materials and equipment for construction. If space is not available for modules, there is potential for modules to be stored off site and transported to site when required.

18.9 Camps and Accommodation

The current accommodation camp has a an approximate 800-person capacity, and an estimated remaining usage life of up to 10 years.

An additional 400 to 600 beds will be needed to support the construction and development phases of the Project as envisaged in the 2021 PFS. Therefore, it was decided to build a new facility for the operations staff and the existing camp will be used

for construction and decommissioned when no longer needed. The 2021 PFS located the facility in an undisturbed area to the south of the existing camp.

The operations accommodation complex is designed with an approximate capacity of 600 beds with the possibility to expand to 800 beds in the future. Common dining and recreation facilities will be designed for 800 personnel. The complex will include dormitories, kitchen, dining room, gymnasium, games room, weight room and lounge.

18.10 Shotcrete/Concrete Supply

A modularized (semi-mobile) shotcrete/concrete batch plant will be constructed above the block cave footprint just outside the limits of the open pit and any subsidence potential from the block caving operations. The plant will have a 45 m³/hr capacity and will deliver shotcrete and concrete underground via a slickline through vertical boreholes and transmixers. Three cement silos (totalling 155 m³ capacity) will be installed to store approximately seven days of underground requirements.

18.11 Power and Electrical

18.11.1 Existing Supply

Power to the Red Chris Operations is provided by BC Hydro via the Northwest Transmission Line, which is a single 287 kV alternating current overhead high voltage electric transmission line from the Skeena Substation, south of Terrace, to the mine 287 kV substation. The current contract with BC Hydro sets the authorized demand at 55 MVA at a 0.95 power factor or better, and current site demand typically fluctuates around 48 MVA.

At the 287 kV substation, two parallel 60/80/100 MVA transformers step the voltage down to 25 kV. These transformers currently operate in parallel to supply the site. The 25 kV power is reticulated around the site using cables or overhead lines, and the voltage is stepped down locally to 4.16 kV or 600 V, depending on the load requirements.

Emergency power requirements for critical systems are provided by two 1.27 MW diesel generators for the operations areas, and one 500 kW diesel generator for the camp.

18.11.2 2021 PFS Requirements

The preliminary load list indicates the total site load requirements to support the block cave project will increase from 45 MW to 100 MW. It is envisaged that this increase will be accommodated by an extension to the existing power supply contract.

The existing 287 kV substation will be increased in capacity with the addition of a third 287 kV/25 kV transformer to accommodate the load increase and to avoid a load-shedding scenario. The substation yard will be expanded to accommodate the additional equipment.

A new mine substation dedicated to the underground area will be installed and located on the conveyor portal pad adjacent to the underground conveyor system. The

substation will be fed by a dedicated 30 MVA line from the main switchyard. A second line will be run from the substation to feed the planned ventilation fans.

Back-up power in the form of two 1.2 MW diesel generators were included at the mine substation at the conveyor portal to provide emergency power to ventilation and mine dewatering loads.

18.12 Fuel

The existing diesel fuel and propane infrastructure will be used for contractor and ongoing fuelling needs. A new diesel fuel depot and propane tanks will be located near the ventilation raises to service underground needs. Diesel will be supplied via a lined borehole to the underground diesel receiving station. Propane will be used to heat the fresh air for the underground ventilation system.

18.13 Air Supply

Compressed air will be provided via a centralized, dedicated duty/standby arrangement of air compressors and dryer located on surface near the conveyor portal.

18.14 Communications

Communications to the site (terrestrial communications) are provided by NorthwTel via a microwave link. The existing site communication networks use a fibre network connected in an ad hoc star network. The open pit wireless network provides communications to the mobile equipment fleet using the MineStar system.

The underground communications infrastructure will be designed so that fixed equipment, people, and mobile equipment, and monitoring devices in all working areas have access to communications.

The intent of the operational technology network is to ensure that the communications technology and deployment underground provide the coverage, high bandwidth, speed, availability, and redundancy to support the required data communications.

18.15 QP Comments on “Item 18: Project Infrastructure”

The QP notes:

- The Red Chris site is a brownfields site, and has infrastructure in place to support current open pit operations;
- The transition to block cave mining and associated changes to processing will be supported by existing infrastructure as well as infrastructure upgrades as identified.

19 MARKET STUDIES AND CONTRACTS

19.1 Market Studies

An evaluation of the copper concentrate market was undertaken as part of the 2021 PFS.

The Red Chris Operations' current market for the open pit concentrate is Asia (primarily China) due to China's comparative advantage i.e., nil or low penalties imposed on the elevated mercury and antimony, and lower transportation cost compared to Europe.

An ongoing dialogue is maintained with smelters globally regarding their interest in the Red Chris Operations' concentrate. For the reasons mentioned above, the strongest demand will remain to be from Chinese smelters, though counterparty evaluation needs to be carefully considered.

19.1.1 Introduction

The majority of the world's copper concentrate production is processed through pyrometallurgical processes in copper smelters and refineries around the world. There is a variety of primary smelting technologies, with recent advances meaning lower copper grades and higher impurity levels can be treated, maintaining high metal recoveries.

The majority of mined copper (about 85%), reaches the market as concentrate, with most of the balance in solvent extraction/electro-winning (SX/EW) cathodes. In the concentrate market, there is a list of undesirable elements that are a hindrance to the smelting and refining process. These elements impact in two ways: by complicating technical processing and requiring control or removal in-process; or, by contaminating waste streams resulting in problems with disposal of waste products. This results in additional costs for the buyer (smelter). As a result, the smelter/refinery will try to recoup the cost from the seller through the application of a penalty charge. The list of these elements includes arsenic, antimony, bismuth, mercury, fluorine, chlorine, and lead. This list has been growing in recent years due to increased vigilance by Chinese environmental authorities. As a result, China has set maximum impurity levels in concentrates which can be imported into the country, the world's largest smelting market.

Mines producing concentrate and smelters smelting concentrate and refining the smelter product (anode) can be categorized as "integrated" or "custom". Integrated mines/smelters produce concentrate from their own mines for feed to their own smelters. Custom producers buy or sell concentrate on the open market. Some integrated producers buy or sell concentrate on the market from time to time to supplement smelter feed or to offload excess mine production. The custom market accounts for approximately 60% of global copper. Of that custom market, about 70% is sold directly to smelters and around 30% to traders.

Annual global copper mine production is estimated to reach 22 Mt in CY21. Of the total primary production, about 18.6 Mt will be in the form of concentrate.

Due to the Chinese restrictions on quality and increased mine production of materials with elevated impurities, there has been an increase in concentrate blending facilities run

as commercial operations by some trading companies. This increase in blending operations could result in an incremental increase of the traders' share of the global custom concentrate market.

Wood Mackenzie forecasts that the copper consumption trend will be robust out to 2040 (Wood Mackenzie, 2021). To feed the growing demand for refined product, smelters have undertaken, or plan to undertake, brownfield and greenfield expansions. This is particularly noticeable in China up to 2026. By association smelters will demand increased primary raw material (concentrate) from mines. Wood Mackenzie (2021) has assessed a base case projection of copper in concentrate mine supply. Before a disruption allowance, copper in concentrate mine supply from existing operations and committed projects is forecast to peak in 2024. Thereafter, base case output will start to decline due to grade attrition and reserve depletion falling to 13.9 Mt by 2040 (Wood Mackenzie, 2021). It follows that additional mine projects will need to come on stream to meet smelter demand, and copper prices will need to be sufficiently high to stimulate this new mine development.

China dominates global copper and copper concentrate demand. Chinese demand for custom concentrate now accounts for ~50% of global demand. Chinese Customs has strict regulations in place for the specification limits for certain elements that could cause environmental and occupational health problems in smelting and refining. Concentrates exceeding these levels cannot be imported into the country. Copper concentrates have such limits for the following impurities: arsenic, cadmium, fluorine, lead and mercury. Red Chris concentrate had exclusively been delivered to the Chinese market at the Report effective date. It is likely that Chinese demand for the product will remain consistent provided impurity levels do not breach Customs import maximum levels. Other smelter markets in Asia may be applicable to Red Chris concentrates and such opportunities will be reviewed.

The additional concentrate tonnage that will be produced from the block cave project will either be added to existing contracts (those contracts will be expanded) or sold to new smelters customers in Asia or Europe with whom direct communication already takes place. It is not expected that Newcrest will need to pay a premium for market access.

19.1.2 Concentrate Production Forecast

The estimate for total concentrate production is about 6.4 Mdmt over the period FY25–FY57 or at an annual average rate of approximately 184,000 dmt. Concentrate production will peak at about 304,000 dmt in FY31.

The grade of copper in the concentrate is estimated to be 23–28% Cu. The average grade over the LOM is forecast at approximately 24.4% Cu. Gold in concentrate is expected to increase compared to the concentrate produced from the open pit, ranging from 14.4–44.8 g/t Au. The anticipated average LOM grade is about 23.8 g/t Au.

Although most custom smelters once sought to feed concentrate at 28–33% Cu on a blended basis, declining grades from major mines have forced them to accept lower concentrate grades. There are two main reasons that concentrate grades have fallen:

- Changes in mineralogy, increased impurities and declining ore grades at mines;
- Increases in copper smelting capacity in China, which has changed the supply-demand balance between mines and smelters, reducing treatment charges, and therefore lowering the incentives for mines to produce high-grade concentrates.

At an average forecast LOM concentrate grade of 24.4% Cu, the Red Chris concentrate is slightly below premium concentrate grades, but is still expected to attract market interest.

19.1.3 Smelter Terms

Mines typically enter into one or more of the following types of contracts:

- Tier 1 Long-term (or frame) contracts between mines and smelters;
- Tier 2 Long-term (or frame) contracts between mines and traders;
- Tier 3 The spot market (via traders).

The duration of a direct mine to smelter contract will be at least two years. Contracts may be rolled over automatically for an agreed period of time if neither party objects, provided it complies with the prevailing Delegation of Authority. Mine to trader contracts generally will not exceed two years.

Spot contracts may cover direct business between mines and smelters, and contracts between mines and traders.

Most long-term contracts specify a fixed annual sales tonnage or tonnage range over multiple years. Most mines place the majority of their production with smelters under long-term contracts but reserve a proportion for merchant spot and merchant long-term sales.

In establishing long-term off-take contracts directly with Chinese smelters, mines must recognize credit risk (on payments), counterparty risks (on long-term ability to accept concentrate as per contract terms), and weight and assay risks (measurement) for some of the ports. Currently, there is an increased geopolitical risk as seen by the Chinese government's blocking of Australian copper concentrate and other goods. Although this Chinese risk can be largely mitigated through a variety of mechanisms and procedures, the risk remains greater than those associated with competing in established markets in Japan, Korea and Europe.

Credit, performance, and measurement risks are similar for sales to India as summarized for China.

19.1.4 Copper Payment Terms

The current typical copper payable by a smelter is 96.5%, subject to a 1.0 unit deduction (minimum) for a copper content of 20–30% Cu. At levels >30–33% Cu, smelters may agree to a higher copper payable rate. However, some smelters have also sought a higher unit deduction for concentrate where the copper grade is <24% Cu. Some

smelters are seeking to impose an additional copper unit deduction of 0.05–0.10 units on concentrates that have grades of 20–22% Cu.

19.1.4.1 Copper Treatment and Copper Refining Charges

For standard-grade copper concentrates (generally regarded as 25–35% Cu), direct mine-smelter annual benchmark copper treatment charges over the past 10 years have varied from US\$56–US\$107/dmt of concentrate, with refining charges from US\$0.056–US\$0.107/lb of payable copper. These terms are for long-term frame contracts between major producers and Asian smelters, and are agreed on an annual calendar year basis.

For higher-grade copper concentrates, smelters may also seek higher treatment charges from producers when the market is in the favour of the smelters to partially compensate the smelters for lower revenue received from the higher-grade producers in terms of ¢/lb Cu. Lower-grade concentrate (e.g., in the range of 22–24% Cu) may pay a series of penalties; especially for new entrants in a surplus market.

19.1.4.2 Copper Concentrate Precious Metal Terms and Refining Charges

The gold payable scale in a sales contract may vary from smelter to smelter. A typical payability scale is shown in Table 19-1. European smelters demand a minimum deduction for gold in the application of the scale.

In Asian markets, silver is paid at 90% of the analytical silver content subject to such content being higher than 30 g/t and no payment is made below 30 g/t. European smelters typically exact a deduction on the silver content.

19.1.4.3 Deleterious Elements

Schedules for most deleterious elements are well established in the market. Typical penalties for deleterious elements are shown in Table 19-2 (Wood Mackenzie, 2021).

As some smelters will be more sensitive to certain elements, those smelters may demand more punitive charges or will set a firm ceiling for those elements in their contracts. From a commercial perspective, smelters will sometimes seek an income stream from penalties, even when those elements may not contribute to an overall deleterious impact on their processes.

From time to time, smelters may attempt to introduce a new penalty element or seek a favourable variation to the penalty structure for a specific element, without a sound technical basis. Some penalty elements, such as arsenic, do not present any technical challenge to smelters, but do contribute to emission and waste disposal costs.

Smelters will typically seek to source up to a specific annual limit of arsenic, to ensure penalty revenue is maximised, without incurring fines or additional disposal costs. As at the Report effective date, smelters were currently claiming heightened sensitivity to mercury and antimony.

Table 19-1: Metal Payable Scale

Gold Grade (g/t)	Japan (%)	China (%)
≤1 g/t	0	0
>1 g/t, ≤3 g/t	90.0	90
>3 g/t, ≤5 g/t	95.0	93
>5 g/t, ≤8 g/t	96.0	94
>8 g/t, ≤10 g/t	96.0	95
>10 g/t, ≤15 g/t	97.0	96
>15 g/t, ≤20 g/t	97.25	96.5
>20 g/t, ≤40 g/t	97.5	97
>40 g/t	97.75	97

Table 19-2: Deleterious Elements Penalty Schedule

Element	Limit	Penalty per DMT Over Free Limit (typical ~US\$/t concentrate)	Range
Arsenic	>0.2%, <0.5%	2 per 0.1% As	US\$2–3 per 0.1% up to 0.5%
	>0.5%, <1%	7 per 0.1% As	US\$5–8 per 0.1% between 0.5–1%
	>1%	10 per 0.1% As	US\$8–12 per 0.1% above 1%
Alumina	3%	1.25 per 1% Al ₂ O ₃	US\$1–2 per 1%
Antimony	0.05%	1.5 per 0.01% Sb	US\$1–2 per 0.01%
Bismuth	0.02%	2 per 0.01% Bi	US\$1.5–3 per 0.01%
Cadmium	0.03%	2 per 0.01% Cd	US\$1–5 per 0.01%
Chlorine	300 ppm	1 per 100 ppm Cl	US\$1–3 per 100 ppm
Fluorine	300 ppm	1 per 100 ppm F	US\$1–2 per 100 ppm
Lead	1%	2 per 1% Pb	US\$1–5 per 1%
Mercury	5 ppm	0.2 per 1 ppm Hg	US\$0.1–0.5 per 1 ppm
Nickel and cobalt	0.5%	1 per 0.1% Ni + Co	US\$1 per 0.1%
Selenium	300 ppm	1.50 per 100 ppm Se	US\$1.50 per 100 ppm
Silica	10%	1 per 1% SiO ₂	US\$1 per 1%
Zinc	3%	4 per 1% Zn	US\$1–5 per 1%

19.1.4.4 Payment Terms

Payment terms with Asian smelters generally allow for 90% payment against a provisional invoice after a period of time (following the carrying vessel's arrival at the port of discharge) ranging from three business days to 15 calendar days.

Credit management between major miners and Japanese smelters generally allow for open account payment. Sales to Chinese, Korean, and Indian smelters are almost always covered by letters of credit.

Sales to traders often includes access to a 100% pre-payment by the trader to the miner, with an interest component at an agreed rate for the early payment.

19.1.4.5 Red Chris Concentrate Specification

There will be a change to the existing product specification from the open pit specifications, resulting from the Red Chris underground operation as summarized in Table 19-3.

The concentrate produced from Red Chris underground ores is expected to be more favourable for customers because:

- Mineralogy of underground ore allows for an increase in copper concentrate grade due to the presence of enriched copper minerals and lower pyrite content in underground ores relative to the open pit;
- Gold grades in concentrate are higher due to an increase gold head grades
- Silver grades in concentrate are higher due to an increase silver head grades
- Slightly lower mercury levels in concentrates

All these aspects make the underground concentrate more attractive than open pit concentrates, which have nevertheless been successfully marketed since the start of operations at Red Chris in 2015.

19.2 Commodity Price Projections

Metal price assumptions were provided by Newcrest management. Newcrest considers analyst and broker price predictions, and price projections used by peers as inputs when preparing the management pricing forecasts.

The metal price and exchange rate assumptions used are included in Table 19-4.

19.3 Contracts

Contracts are in place in support of the open pit mining and processing operations and include mill consumables, power, explosives, transportation, and camp facilities. Contracts are also in place with equipment vendors, drilling contractors, and for concentrate loading and storage.

Table 19-3: Anticipated Product Specification Changes

Product	Unit	Open Pit (approximate range)	Underground (approximate range)
Cu	%	22–25	23–28
Au	g/t	5–15	14–44
Ag	g/t	20–50	48–94
Hg	ppm	13–60	12–27
Antimony	ppm	180–1,450	217–822

Table 19-4: Metal Price and Exchange Rate Forecasts

	Units	FY22	FY23	FY24	FY25	FY26+
Gold price	US\$/oz	1,750	1,700	1,550	1,500	1,500
Copper price	US\$/lb	3.75	3.50	3.30	3.30	3.30
Exchange rate	C\$:US\$	0.80	0.80	0.80	0.80	0.80

Contracts that are likely to be concluded in support of the block cave underground project include decline development, pipelines, conveyors, camp construction, port and roads. Major contracts in support of operations are likely to include: accommodations camp management, building maintenance, underground mine infrastructure development, cave establishment, road maintenance, explosives supply, ground support and consumables supply, material transport and logistics to the preferred port site, infrastructure engineering procurement and construction management, labour training, and infrastructure construction.

Current contracts are typically reviewed and negotiated on a frequent basis. Contract awarding is in accordance to the procurement standard and a delegation of authority process. Based on Newcrest’s knowledge, the contract terms are typical of similar contracts both regionally and nationally. It is expected that future contracts will be awarded and negotiated in a similar manner to contracts that are currently in place.

19.4 QP Comments on “Item 19: Market Studies and Contracts”

The QP notes:

- Market studies were conducted. The LOM Red Chris copper concentrate from the underground operations is expected to be relatively high in copper and low in impurities, and be saleable. Copper grades in the copper concentrate are expected to increase by a modest amount when the underground mine comes into production;
- Forecast payability and deduction assumptions appear reasonable;
- As additional tonnage at Red Chris is produced from the block cave project, it will either be added to existing contracts (those contracts will be expanded) or sold to

new smelters customers in Asia or Europe with whom direct communication already takes place. It is not expected that Newcrest will need to pay a premium for market access;

- The terms contained within any future concentrate sales contracts would be expected to be typical of and consistent with regional and international standard industry practice;
- No concentrate sales contracts are currently in place in support of the proposed block cave project. Contracts will be negotiated and renewed as needed. Contract terms are expected to be within industry norms;
- Newcrest considers analyst and broker price predictions, and price projections used by peers as inputs when preparing the management pricing forecasts.

The QP is of the opinion that the marketing and commodity price information is suitable to be used in the cash flow evaluations supporting Mineral Reserve estimates.

20 ENVIRONMENTAL STUDIES, PERMITTING, AND SOCIAL OR COMMUNITY IMPACT

20.1 Introduction

Extensive environmental baseline data collection and monitoring of the area has occurred since 2003. Site-specific baseline studies were completed to support the 2004 Environmental Assessment Application and subsequent 2010 Joint *Mines Act* and *Environmental Act* Permit Application, as well as associated addendums to permit applications.

Following receipt of the EA certificate (M05-02), *Mines Act* (MA) permit (M-240), and *Environmental Management Act* (EMA) permit (105017), approvals for mine construction commencement (2012) and operational authorization (June 2015), the Red Chris Operations have continued to collect comprehensive environmental monitoring data to support effective environmental management.

Newcrest's primary environmental permits and authorizations include:

- *Environmental Assessment Act* EA certificate M05-02;
- *Mines Act* Permit M-240;
- *Environmental Management Act* Permit 105017 (effluent discharge) and Permit 100669 (air emissions);
- *Fisheries Act*, Metal and Diamond Mine Effluent Regulation; monitoring and reporting requirements;
- Restated and Amended 2019 Impact Benefit Co-Management Agreement; environmental co-management and communication commitments to the Tahltan Nation.

20.2 Baseline and Supporting Studies

An environmental risk assessment and a gap analysis were performed during the 2021 PFS for the inherent (uncontrolled) risks and the current (residual) risks remaining, in terms of likelihood and consequence, assuming the implementation of controls and mitigation. The gap analysis identified several areas requiring additional baseline characterisation work, such as hydrogeology, aquatic resources and fisheries.

Subsequent 2021 PFS baseline studies leveraged a wealth of data from previous baseline studies, dating back as early as 2003, including: dust; potential visual impacts; social and communities; air quality; meteorology; groundwater and surface water quality and quantity; hydrogeology; aquatic resources and fisheries; terrestrial ecosystems including vegetation and wildlife; and cultural heritage/archaeological studies.

Additional baseline characterization work is underway to address gaps identified, above, and additional information is planned to be collected in the areas of dust, noise, and air quality to assess the impacts of potential incremental Project increases. Further archaeological assessment will be carried out and the social baseline assessment expanded.

Closure studies for the 2021 PFS leveraged previous studies on land use and reclamation of the Red Chris site, and focused on establishing a holistic closure and reclamation plan to integrate with the existing closure plan for the open pit operation. More work is planned in subsequent study phase to further reduce risks associated with long-term water (quantity and quality) and metals leach/acid rock drainage management post-closure, and will incorporate social aspects of closure planning and input from Tahltan engagement.

20.3 Environmental Considerations/Monitoring Programs

There is an environmental management system (EMS) in place for the open pit operations, which includes associated plans, procedures, policies, guidelines, auditing, and compliance.

The EMS and environmental management plans (EMPs) were developed based on an adaptive management strategy that requires periodical reviews of the EMPs, mitigation measures, and efficacies, to determine whether the regulatory requirements and environmental commitments are being met. This adaptive management strategy has undergone extensive regulatory and stakeholder consultation as an important component of an effective EMS.

Monitoring plans, which are developed in consultation with regulatory and Tahltan Environmental Oversight Committee input through the Red Chris Monitoring Committee, include detailed individual monitoring components and are linked to a monitoring or trigger response program. Response plans, and associated implementation processes, monitor for unpredicted environmental changes or exceedances of the environmental quality standards and describe the corrective actions or processes that are appropriate for each environmental change or exceedance.

An environmental planner is used on site to schedule the timing of requirements and commitments relating to the operations and includes environmental monitoring, reporting, audits, inspections, reviews, tasks, and training. The planner is regularly updated and managed by the Environmental Department and used as a planning tool to ensure compliance.

Environmental incidents are reported in accordance with regulatory and internal requirements. The operations investigate reported incidents in a timely manner to identify and implement appropriate preventive and remediation measures; these investigations consider the actual and the potential outcome of an incident.

Responsibilities and accountabilities for the provision of environmental management are assigned to all personnel throughout the operations by means of EMPs, standard operating procedures, and position descriptions.

The EMS and EMPs will be updated to incorporate the block cave project. Key mitigation measures that have been identified for impacts assessed during the 2021 PFS will inform the updates to the EMPs.

20.4 Closure Plan

A closure plan was developed for the 2021 PFS for the closure of the proposed block cave operation in its entirety, including works associated with the existing open pit operations.

Under the M-240 permit, the primary end land use goal is to return the disturbed area available for reclamation to pre-mining capability for wildlife habitat, particularly for species specified in the Wildlife Management Plan and opportunities for recreation and re-establishment of opportunities for traditional use of the land by the Tahltan Nation. Prior to mine development, land use around the Mine Permit Area consisted of wildlife habitat, backcountry wilderness tourism and recreation, hunting, trapping, guide-outfitting, and mineral exploration.

Under the British Columbia Environmental Management Act and the Mines Act, maintenance of a five-year mine plan and a closure plan are required for mines operating in British Columbia. For Red Chris, both plans are required to be updated with the Mine Review Committee (MRC) every three years as a condition of the M-240 permit. The closure plan currently approved is for the closure of the existing facilities to support the open pit mine at Red Chris.

A reclamation bond is required to be updated according to the disturbance areas and facilities associated with the M-240 permit.

The closure plan for the proposed block cave project was completed for the purposes of development of a closure cost estimate. The estimated total exit cost for the block cave project including decommissioning, closure, and reclamation of mine infrastructure associated with the existing open pit mine is approximately C\$181 M.

20.5 Permitting

20.5.1 Current Permit Status

The Red Chris Operations were assessed and approved under applicable provincial and federal legislation. The operations obtained an EA certificate (M05-02) on 24 August 2005 under predecessor legislation to the *Environmental Assessment Act* (EAA).

The EA certificate was set to expire on the fifth anniversary of issue unless, on or prior to that time, the construction of the operations was substantially started. An extension of the EA certificate for a further five-year period was requested on 10 February 2010 and obtained in July 2010, with an extension to substantially start the mine by 24 August 2015.

The EA certificate has been amended four times:

- 24 February 2012: Amendment 1 amends Condition 1 of the EA certificate to reflect more recent language for proposed changes to the EA certificate and to add a requirement for compliance reporting to the EA certificate (Condition 8);
- 19 August 2016: Amendment 2 amends commitments G10, M11, and M12 of the EA certificate to allow design changes around the TIA and design changes to the South dam related to water management;
- 15 August 2019: Amendment 3 amends the EA certificate to the name of Newcrest Red Chris Mining Limited;
- 3 May 2021: Amendment 4 amends the EA certificate to allow the operations to provide housing for up to 800 people.

Federal environmental assessment approval under predecessor legislation to the *Impact Assessment Act* (the former *Canadian Environmental Assessment Act* (CEAA) (SC 1992, c. 37)) was received in May 2006 and upheld by a Supreme Court of Canada decision on 21 January 2010 ([2010] 1 SCR 3-328).

The operations also hold:

- *Mines Act* permit M-240, issued on 4 May 2012 and amended on 12 occasions. The most recent amendments included:
 - 8 February 2021: approval of box cut and portal construction (Phase 1 exploration decline);
 - 27 April 2021: construction approval for the exploration decline (Phase 2 exploration decline);
 - 14 June 2021: approving ultimate pit redesign;
- EMA permit 105017, issued on 9 May 2012, for effluent discharges and amended on six occasions;
- EMA permit 106668, issued on 7 June 2013, for air discharges and last amended on 7 November 2017;
- EMA permit 106004 for wastewater discharges.

The EMA permits are undergoing a review initiated by the Ministry of Environment and Climate Change Strategy, Canada (ENV). EMA permit 105017 for effluent discharge was initiated for revision in 2019 and update of language by ENV; monitoring plan commitments and site performance objectives are being developed by ENV in consultation with Newcrest and the Tahltan Central Government for targeted completion in late 2021. EMA 106668 permitting air discharge amendment was initiated in 2020 by the Red Chris Operations to update discharge points and monitoring programs; review has been delayed due to lack of ENV resources and an update is anticipated to be returned from ENV by early 2022. EMA permit 106004 for wastewater discharge is

undergoing a review initiated in 2021 to update the permit to align with the Municipal Wastewater Registration of the wastewater treatment plant upgrades in 2020.

On 6 May 2016 the operations were granted a Schedule 2 Amendment to the Metal and Diamond Mining Effluent Regulations (MDMER; SOR 2002-222) authorizing the inclusion of a portion of Trail Creek, thus enabling the use of water frequented by fish for mine tailings disposal. On 22 July 2016, the operations received a *Fisheries Act* authorization under to Section 35(2) for construction of the South dam and South Reclaim dam in Trail Creek.

20.5.2 2021 PFS Permit Requirements

20.5.2.1 Environmental Permitting

The Reviewable Projects Regulation (RPR, BC Reg. 67/2020) under the EAA sets out the criteria for determining which projects are required to undergo an EA. Projects are typically reviewable if they meet or exceed certain project design or effects thresholds (such as production volume, storage capacity, area of disturbance) defined in the Reviewable Projects Regulation or if they are required to undergo an assessment by the provincial ENV. If a project does not meet the prescribed criteria under the Reviewable Projects Regulation (and it is not designated by the ENV to undergo an EA), it is not required to undergo a formal EA review process.

Newcrest understands that the block cave project does not meet or exceed the thresholds defined in the Reviewable Projects Regulation; therefore, except in the event that the Project is designated by the ENV, the Project will not require a new EA certificate. However, amendments to the EA certificate will be required in connection with certain phases of the block cave project (such as underground mining) where the activities to be undertaken during such phases are not authorized by the existing EA certificate.

Under Section 32(1) of the 2018 EAA, an EA certificate holder may apply to the EAO for an amendment. The EAO categorizes amendments into types (simple, typical, or complex) in order to provide applicants with guidance on what potential information requirements, procedures, engagement, and timelines could be part of an amendment assessment. EAO staff will determine the nature of the amendment and establish the requirements for the amendment process. Depending on the potential complexity of the proposed amendment, the EAO may set out supplementary application requirements that may include information typically included in a detailed project description.

Section 7 of the Bill-41: *Declaration on the Rights of Indigenous Peoples Act* sets out provisions for negotiating consent-based decision-making agreements for the purposes of reconciliation. On 15 June 2021, in terms of Section 7, Order-in-Council Number 348 was deposited on the BC laws ordering that the Minister of Indigenous Relations and Reconciliation is authorized, on behalf of the government, to negotiate an agreement with the Tahltan Central Government relating to the consent of the Tahltan Central Government in respect of decisions under the EAA related to the Red Chris Operations. Newcrest will pursue engagement opportunities with the BC government and the Tahltan

Central Government in order to gain a clear understanding of the process and scope of the consent and the potential impact on the block cave project.

20.5.2.2 Permit Plan

It is proposed that the permitting strategy will follow a phased approach, including:

- Phase 1: exploration decline box cut and portal;
- Phase 2: exploration decline development;
- Phase 3: pre-mining underground development including an extension to the decline, development of the conveyor decline, preconditioning, access to the ore body and underground development to support the block cave infrastructure;
- Phase 4: block cave mining of MB1;
- Phase 5: block cave mining of MB2 and MB3.

Permitting for development of the exploration decline (Phases 1 and 2) is complete and the exploration decline is under construction.

20.5.2.3 Exploration Decline

The exploration decline required an amendment to the M-240 permit. The ENV confirmed that an amendment to EMA Permit 105017 was not required as there was no mine contact water discharge to the environment. No other provincial permitting or federal permitting or authorizations and processes were triggered or required for the exploration decline.

20.5.2.4 Access and Conveyor Declines

Permitting for development of the access and conveyor declines is referred to as Phase 3AB reflecting the initial planning of a two-stage permitting process. Facilities/activities to be permitted in this phase include:

- Access decline;
- Conveyor box cut and decline;
- Tailings thickener.

This work phase will require amendments to the *Mines Act* M-240 permit. An amendment to EMA Permit 105017 is not expected to be required by ENV as no mine contact water discharge to the environment is envisaged. Newcrest will engage with FLNRORD with respect to an exemption under the *Water Sustainability Act* to dewater underground workings.

Because the access and conveyor declines are not related to exploration activities, EAC M05-02 will need to be amended for these underground works. Newcrest proposes to amend the EAC using Condition 1.1 of EAC M05-02, which allows for a “deemed” amendment for minor changes to the permitted project configuration, provided that

certain conditions related to environmental and social aspects are demonstrated to be achieved. After consulting with the Tahltan Central Government, Newcrest submitted a request letter to amend EAC M05-02 under Condition 1.1 to the EAO, and is awaiting response.

Should provincial authorities not agree to amend the EAC via Condition 1.1, it is likely that an amendment under Section 32(1) of the BC EAA will be required. This is not forecast to affect the permitting timeline.

No other provincial permitting or federal permitting or authorizations and processes are expected to be triggered or required for the Phase 3AB works.

20.5.2.5 Preconditioning, Large Excavations and Underground Development

Further pre-production underground development is referred to as Phase 3C and will include pre-conditioning and additional underground development including the pump station chamber, crusher chamber and underground workshop. This work will require an EAC amendment, MAP amendment, and likely an amendment to the EMA permit.

20.5.2.6 MB1

The mining of MB1 is referred to as Phase 4 in the permitting plan. The mining of MB1 will not necessitate an expansion of the TIA beyond the existing permitted 300 Mt configuration, and will entail little additional surface disturbance as the subsidence zone will be mostly within the permitted footprint of the open pit. Accordingly, permitting will be at the provincial level and, like Phase 3C, will include an EAC amendment and a joint MAP/EMA permit amendment. The application review process is assumed to be carried out jointly or concurrently by the Tahltan Central Government and provincial regulators pursuant to an agreement under Section 7 of the provincial Declaration on the Rights of Indigenous Peoples Act.

MA and EMA permit amendment applications are expected to be submitted and reviewed concurrently during the EA certificate amendment process. It is possible that the EA certificate amendment process will include modernization, which may broaden the scope of the review.

20.5.2.7 MB2 and MB3

Extension of the mine's operating life beyond 2040 through the mining of MB2 and MB3 may trigger the need for environmental review at the federal level under the *Impact Assessment Act* and will likely entail permitting under the *Fisheries Act*, in addition to provincial permitting including another amendment to the EAC and amendments to the MA and EMA permits. These permitting activities are assumed to be initiated after 2035.

20.6 Considerations of Social and Community Impacts

The mining operations are located entirely within the Tahltan Nation's territory. The proposed block cave project requires an approach that aligns with the Tahltan Nation and leadership and with provincial governments. This is planned to include:

- Open and transparent consultation and communication in describing the Project's activities and assessment of alternatives;
- Working partnerships with Tahltan and government to ensure the social and community relations programme is well designed and effectively delivered;
- Recognising and respecting Tahltan rights and interests;
- Compliance with statutory and regulatory obligations.

Since initiating discussions on exploration and Red Chris Operations activities, Newcrest representatives continued to meet regularly with Tahltan Central Government representatives, Tahltan leadership, and the Tahltan Nation. While feedback has been largely positive, a range of concerns and interests have been raised. Newcrest is actively working with Tahltan Central Government representatives, Tahltan leadership, and the Tahltan Nation to address concerns that have been raised.

In April 2020, Newcrest commenced discussions with representatives of the Tahltan Central Government to develop and implement a participatory social baseline study to provide social, economic, and cultural information relevant to deepen Newcrest's understanding of the Tahltan Nation and local communities.

20.7 QP Comments on “Item 20: Environmental Studies, Permitting, and Social or Community Impacts”

The QP notes:

- Extensive environmental baseline data collection and monitoring of the area has occurred since 2003. Baseline and supporting studies were completed for the current open pit mining operation. Additional studies are ongoing in support of the block cave project, and/or planned to be completed prior to the commencement of underground operations;
- A gap analysis identified several areas requiring additional baseline characterisation work;
- The permitting strategy for the proposed block cave project will follow a phased approach;
- Permitting for development of the exploration decline (Phases 1 and 2) is complete and the decline is under construction.

21 CAPITAL AND OPERATING COSTS

21.1 Introduction

The capital and operating costs are presented for the open pit and proposed block cave underground operation.

21.2 Capital Cost Estimates

21.2.1 Open Pit

21.2.1.1 Basis of Estimate

The capital costs for the open pit operations are considered to be sustaining capital. The cost breakdown is provided in the discussion in Section 21.3.1 on operating costs.

As the open pit is operating, the estimated life of mine costs are based on actual expenditure as of FY21Q4 and forward-looking estimates.

21.2.1.2 Sustaining Cost Estimate

The major portion of the open pit sustaining capital costs relates to TSF enhancements particularly in FY22 and FY23. Other items include mill maintenance, mine fleet replacements, and contingency.

21.2.1.3 Processing Cost Estimate

Processing costs are based on FY21Q4 operating costs with modifications for liner and mill shutdown optimisation and additional reclaim stockpile movements.

21.2.1.4 General and Administration Cost Estimate

G&A costs are based on FY21Q4 operating costs with modifications for fly-in-fly-out optimisation, site services maintenance optimisation and allocation of G&A to underground operations as open pit mining reduces.

21.2.1.5 Mining Cost Estimate

Mining costs are based on FY21Q4 operating costs and assumptions of forward-looking productivity gains.

21.2.2 Block Cave Underground

Capital cost estimates were prepared for the process plant expansions and underground development to produce an estimate with a target accuracy of $\pm 25\%$. All inputs were in Q2 2021 Canadian dollars.

Costs were estimated with a bottom-up unit cost and productivity approach, and were cross-referenced with benchmark data.

Footprint mine designs considered haulage scenarios that use single as well as multiple crusher layouts. The reduced distances and the inclusion of a truck loop resulted in a single crusher configuration being selected as the preferred option, substantially reducing the capital required in MB2 and MB3.

Capital costs were estimated based on a 13.6 Mt/a Central Case (that forms the base case) and a 15 Mt/a Upside Case (that forms an alternative case). The Upside Case estimate was a modification of the Central Case with the following changes:

- Underground mine development and production modified for higher tonnage;
- Process plant upgrade with the HydroFloat system;
- Changes to infrastructure to support the above.

21.2.2.1 Basis of Estimate

The capital cost estimate for the proposed block cave is divided into:

- Initial capital for MB1: includes all expenses up to the completion of underground mine development required to access MB1, material handling systems, and process plant upgrades;
- Initial capital for MB2: includes the incremental underground development capital expenditure required to access this section of the orebody;
- Initial capital for MB3: includes the incremental underground development capital expenditure required to access this section of the orebody;
- Sustaining capital;
- Closure and rehabilitation costs.

The capital cost estimate was based on a coding system, including a work breakdown structure, commodity coding, and cost element code format.

All costs in the estimate were based on the estimate base date. Where historical data were used as a reference for pricing of equipment and materials, prices were escalated to the estimate base date using producer price indices.

21.2.2.2 Labour Assumptions

The direct labour rates were based on a composite crew (considering a craft mix of supervisors, experienced tradespersons and apprentice helpers) for various types of activities, organized by commodity code. The hourly rate per each trade was based on British Columbia construction worker agreements. The base work week hours were 12 hours/day, seven days/week. Assumed work schedules were:

- Underground: 14 days on, 14 days off;
- Construction: 21 days on, 7 days off;

- Production: 14 days on, 14 days off;
- Management: 8 days on, 6 days off.

The construction equipment cost was estimated as dollars per labour hour of direct work for each installation crew used in the estimate. The construction equipment rates were based on hourly, weekly, and monthly rental quotes in the area and applied contractor equipment depreciation cost, insurance, fuel, oil, lubricants, maintenance, equipment service, and repair.

An appropriate fleet of equipment was assigned to each installation crew used in the estimate based on the nature of the activity.

Productivity factors were applied to direct field labour hours in order to compensate for labour productivity loss on the job site, and were developed for each commodity code used in the estimate for above ground greenfield, brownfield, and underground work.

Distributables were applied as a percentage mark-up to the labour cost. Itemized percentage allowances were obtained from similar projects.

21.2.2.3 Equipment and Materials

Third-party consultants supplied pricing for the equipment and materials within their scope of work. Supporting quotations were provided for most major equipment. For some items, allowances were added to quoted supply prices to include ancillary equipment if that equipment was not included in the scope of the quote.

Pricing for materials was based on recent contracts and quotations received from suppliers. Material wastage was included in the unit material cost.

21.2.2.4 Quantities

Quantities were estimated for design growth, underground mining, civil works, concrete, structural steel, architectural, mechanical equipment, piping and electrical, and instrumentation and automation.

The specific estimating techniques used to develop quantities varied by the level of engineering completed by each third-party consultant contributing to the estimates. Quantities from consultants were based on a mix of material take-offs, factors, and allowances.

21.2.2.5 Indirect Costs

Indirect costs were developed based on the work breakdown structure. They included allocations for construction indirect costs (support services), Engineering, procurement and construction management (EPCM) costs, temporary construction facilities, temporary services, plant and equipment, freight/traffic warehouse services and logistics, environment, health and safety, spares, first fills, commissioning indirect costs, project delivery services, Owner's team, studies, government, community and environment, finance, legal and insurance, operational readiness, pre-production costs, other capital

costs, escalation, allowances and contingency, foreign exchange, escalation, provisions/allowances, and contingencies.

The EPCM costs were estimated from the direct cost using percentage factors. Engineering and procurement services were estimated separately for each consultant scope, and ranged from 6–8.5% of the direct cost.

Engineering and QA/QC costs for the tailings scope, which will be performed by a third-party consultant, were estimated to be approximately C\$101 M, based on annual allowances for the LOM. This cost was considered to be sustaining capital; however, no other EPCM allowances were included for sustaining capital projects that would be Newcrest-performed.

21.2.2.6 Owner's Costs

Owner's cost allocations made provision for:

- Feasibility study;
- Project execution and administration by Owner's team;
- Government, community and environment costs;
- Finance, legal and insurance costs;
- Operational readiness costs.

21.2.2.7 Contingency

The engineering maturity and pricing maturity data captured in the estimate were modelled to reflect the uncertainty and risk using a deterministic statistical process. Contingency allocations were based on whether the estimate was detailed, factored, estimated, historical, allowed, or from an informal quote.

The total contingency was C\$396 million or 17.9% of the base estimate of initial capital expenditure (including MB1, MB2 and MB3).

21.2.3 Capital Cost Summary

All open pit capital costs are considered to be sustaining capital and are summarized with the operating costs.

The capital cost estimate from the 2021 PFS is summarized in Table 21-1 for the planned underground operation. The estimate totals C\$2,632 M.

Table 21-1: 2021 PFS Capital Cost Estimate Summary

Item Estimate (FY22 Real)	Unit	MB1	MB2	MB3	Total
Underground mining (underground mine)	C\$ M	772	179	375	1,326
Raw feed (materials handling)	C\$ M	58	—	—	58
Treatment (plant services & utilities)	C\$ M	157	—	—	157
On-site infrastructure	C\$ M	188	—	—	188
<i>Sub-Total Direct Cost</i>	C\$ M	<i>1,175</i>	<i>179</i>	<i>375</i>	<i>1,729</i>
Construction indirect costs (support services)	C\$ M	286	19	39	344
Project delivery services	C\$ M	135	10	19	164
Contingency	C\$ M	298	32	66	396
<i>Sub-Total Indirect Cost</i>	C\$ M	<i>719</i>	<i>61</i>	<i>124</i>	<i>903</i>
<i>Total</i>	C\$ M	<i>1,893</i>	<i>240</i>	<i>499</i>	<i>2,632</i>
Indirect	%	61.2	34.0	33.0	52.2
Contingency	%	19.0	15.3	15.2	17.9

21.3 Operating Cost Estimates

21.3.1 Open Pit

21.3.1.1 Basis of Estimate

The Red Chris open pit is an operating mine with production history. As such, capital costs are treated as sustaining capital operating costs rather than treated as initial capital.

The operating costs were estimated during FY21Q4 forecast period and represent the total open pit cost estimate for the remaining LOM (e.g., before the underground block caving operation is fully implemented).

Four major line items make up the open pit operating cost estimate:

- Processing cost;
- G&A;
- Sustaining capital operating cost;
- Mining cost.

The current estimated open pit cost forecasts are mining cost at US\$2.90/t mined, milling cost at US\$6.70/t milled, G&A costs at US\$3.30/t milled and sustaining capital at US\$3.60/t milled for an overall process cost of US\$13.60/t processed. These values were used to define the open pit mine plan. Values used for the operating cost estimate

will not necessarily match those provided in the economic analysis that has validated the mine plan.

Table 21-2 shows the LOM open pit operating costs that are estimated on an annual basis and divided by total material movement for mining cost and mill tonnes for processing cost. Costs are calculated in Canadian dollars and reported in US dollars.

21.3.2 Block Cave Underground

21.3.2.1 Basis of Estimate

No escalation was included in the operating cost estimates, nor was a contingency allocation made during estimation.

Cost items were calculated as either:

- Labour as wages or salaries, including burdens, taxes, transportation, and any other compensation;
- Mobile equipment, including ownership (if leased or rented), maintenance, and energy requirements;
- As a percentage of the capital costs per year (typically used for maintenance allowances);
- Based on a variable consumption rate and unit price;
- Fixed recurring cost calculated based on the operating plan or appropriate allowances.

The operating cost estimate is presented at an estimation accuracy of $\pm 25\%$. All inputs were in Q2 2021 Canadian dollars.

Economic assumptions were fixed for the operating cost estimate:

- Exchange rates;
- Fuel prices, including delivery;
- Electricity price.

Variable costs were linked to production parameters defined by the mining schedule, milling schedule, or derived from consultant inputs as required.

Labour salaries for permanent employees as well as the expected number of people in each position were defined for each area. Production operators and maintenance personnel were assumed to work on a two-weeks on, two-weeks off basis. Management was assumed to work eight days on, six days off. All personnel were assumed to work 12-hour shifts when on site.

Table 21-2: Open Pit LOM Operating Cost Forecast

Type	Units	Total	FY22	FY23	FY24	FY25	FY26	FY27	FY28
Exchange rate	US:CAN		0.80	0.80	0.80	0.80	0.80	0.80	0.80
Tonnes moved	Mt	227.4	46.8	43.9	43.8	40.1	37.4	14.5	0.9
Tonnes milled	Mt	75.0	10.5	11.0	11.0	11.0	11.0	11.0	9.6
Mining Cost	US\$/t	2.9	3.1	3.2	2.5	2.7	2.8	2.8	1.2
Milling	US\$/t	6.7	6.9	6.5	6.3	6.3	6.3	7.2	7.2
G&A	US\$/t	3.3	4.7	3.7	3.6	3.5	3.3	2.2	1.9
Sustaining capital	US\$/t	3.6	8.5	7.0	2.3	2.3	2.2	1.6	1.6
Processing + G&A + Sustaining Capital Cost	US\$/t	13.6	20.1	17.3	12.3	12.0	11.8	10.9	10.7

21.3.2.2 Mine Operating Costs

The basis of the costs for mining operations was developed as part of the integrated mine production plan and schedule, which includes the required number of units of equipment and operators on a monthly basis for the LOM.

The labour positions indicated on the mine plan were mapped to the master labour positions, with variable manpower numbers, depending on the mine plan requirements. The number of personnel per crew was multiplied by four to account for two shifts (day/night), and two rotations, as production operations will be continuous.

Mine production equipment costs include maintenance and fuel consumption based on the hourly rates and equipment utilization.

Mine technical services will have a total of 36 personnel according to the labour positions list. The total cost for these personnel is C\$5.5 M/a.

Permanent equipment operating costs include maintenance supplies, power, and fuel for all underground systems and infrastructure. Inputs for these costs were provided by third-party consultants. These costs vary from year to year based on operating parameters.

21.3.2.3 Process Operating Costs

The process area assumed a personnel count of 105, including management, technical services, and operators. The total cost for these personnel is C\$12.4 M/a.

Equipment maintenance and power costs for the existing process plant were based on a nominal process capacity of 11 Mt/a, cost estimates, and FY2023 operating budget forecasts.

Equipment costs for the coarse ore crushing and regrind mill areas are removed from the estimate when the process plant upgrades are complete.

Equipment maintenance and power costs for the new process plant operations were based on a 13.6 Mt/a throughput rate.

Reagents and consumables costs for the process plant were jointly developed by a third-party consultant and the Red Chris Operations.

The FY23 budget of C\$1.03 M for metallurgy and assaying supplies was carried as a fixed annual cost.

21.3.2.4 Tailings

The TIA will require 44 persons. The total labour cost is C\$5.7 M/a.

Tailings and reclaim equipment maintenance and power costs were based on the FY2023 forecast operating budget:

- C\$1.8 M/a for maintenance supplies;
- Power consumption of 53.5 GWh per year.

Maintenance and power costs for water system upgrade were based on:

- C\$0.2 M/a for maintenance supplies;
- Power consumption of 7.0 GWh per year.

21.3.2.5 Infrastructure Operating Costs

The infrastructure operating costs include all maintenance personnel for above-ground facilities, including process plant, infrastructure, ancillary buildings, tailings equipment, and site services, with the personnel count totalling 133. Labour costs total C\$15.6 M/a.

Maintenance and power costs for existing infrastructure were based on the FY2023 forecast operating budget. Maintenance and power costs for new infrastructure were based on third-party estimates.

Existing propane usage includes 220 m³ for the camp and 593 m³ per year for all other site facilities. Forecast usage for the surface facilities are expected to remain in line with the current usage.

An annual allowance of C\$78,180 was made for water and sewage treatment costs.

21.3.2.6 General and Administrative Operating Costs

General and administrative costs were estimated based on the FY23 operating budget.

Utility price assumptions were:

- Diesel: C\$1.230/L;
- Propane: C\$820/m³;
- Electricity: C\$0.0674/kWh.

A total of 55 personnel are allocated to G&A operating costs. The G&A fixed cost budgets include an estimated 116 additional personnel, including management, administration, human resources, health and safety, and other areas.

Annual G&A costs total C\$50 M.

21.3.3 Operating Cost Summary

The operating cost estimate is summarized in Table 21-3 for the planned underground operation on a dollar per tonne processed basis, and in Table 21-4 by major area.

The annual average operating cost estimate for underground ore in the 2021 PFS totals C\$271 M. On a cost per tonne milled basis, mining costs average C\$5.65, process costs average C\$10.36, and site G&A costs average C\$4.33, for a total LOM average cost of C\$20.34.

21.4 QP Comments on “Item 21: Capital and Operating Costs”

The combined open pit and block cave project capital cost estimate is C\$4,991 M.

Operating costs over the combined open pit and block cave project LOM are C\$9,900 M.

Table 21-3: Operating Cost Estimate, 2021 PFS (C\$/t processed)

	MB1	MB2	MB3	Total
Mining	4.99	5.96	5.96	5.65
Processing	10.36	10.36	10.36	10.36
Site G&A	4.33	4.33	4.33	4.33
Total Cost	19.68	20.65	20.65	20.34

Note: Processing in this table is includes ore treatment + on-site infrastructure

Table 21-4: Operating Cost Estimate, 2021 PFS (by area)

Area	Description	Cost per Tonne (C\$/t milled)
200	Underground mining (Underground Mine)	5.44
300	Raw feed (materials handling)	0.21
400	Treatment (plant services & utilities)	7.10
500	On-site infrastructure	3.26
800	General & administrative	4.33
900	Operating contingency	—
	Total	20.34

Note: numbers have been rounded. Totals may not sum due to rounding.

22 ECONOMIC ANALYSIS

22.1 Forward-Looking Statements

This economic analysis includes forward-looking statements. Forward-looking statements can generally be identified by the use of words such as “may”, “will”, “expect”, “intend”, “plan”, “estimate”, “anticipate”, “continue”, “outlook” and “guidance”, or other similar words and may include, without limitation, Mineral Resource and Mineral Reserve estimates, statements regarding plans, strategies and objectives of management relating to the Project including the proposed mine plan, projected mining and process recovery rates and assumptions as to mining dilution, anticipated production or construction commencement dates, expected costs or production outputs and assumptions as to closure costs and requirements; assumptions as to environmental, permitting and social risks. Forward-looking statements inherently involve known and unknown risks, uncertainties and other factors that may cause the actual results, performance and achievements of the Project to differ materially from statements in this analysis. Relevant factors may include, but are not limited to, changes in external economic factors such as commodity prices, foreign exchange fluctuations, interest rates and tax rates, unanticipated changes in sustaining and operating costs, unexpected variations in the quantity of mineralised material, grade or recovery rates, unexpected changes in the environmental or in geotechnical or hydrological conditions, a failure of mining methods to operate as anticipated, a failure of plant, equipment or processes to operate as anticipated, and the risks relating to permitting, licensing and maintaining a social license to operate.

The production schedules and financial analysis annualised cash flow table are presented with conceptual years shown. Years shown in these tables are for illustrative purposes only. Additional mining, technical, and engineering studies requested as part of the permitting process may result in changes to the project timelines presented.

22.2 Methodology Used

The Red Chris Operations were valued using a discounted cash flow (DCF) approach. Estimates were prepared for all the individual elements of cash revenue and cash expenditures.

The resulting net annual cash flows are discounted back to the date of valuation of start-of-year 30 June 2021. A discount rate of 4.50% was used. The Red Chris Operations economics are presented on a 100% basis. Newcrest holds a 70% interest.

22.3 Financial Model Parameters

22.3.1 Mineral Reserves and Mine Life

Mineral Reserves used in the economic analysis were based on the estimate in Table 15-3. The assumed mine life duration is 36 years, from FY22 to FY57.

A production profile was included as Figure 16-13 and Figure 16-14.

22.3.2 Metallurgical Recoveries

Over the LOM of the integrated open pit and underground production plan, copper recoveries will range from approximately 75–85% and gold recoveries will range from 48–76%. The average concentrate grade over the LOM is forecast at approximately 24.4% Cu.

22.3.3 Smelting and Refining Terms

Smelting and refining cost assumptions were outlined in Section 19.1.3 and Section 19.1.4.

22.3.4 Metal Prices

Forecast metal prices and exchange rates were provided in Table 19-4.

22.3.5 Capital and Operating Costs

The capital cost estimate is summarized in Table 22-1, and the operating cost forecast in Table 22-2.

22.3.6 Royalties

Royalty provisions applicable to the financial model include:

- Provisions made to the Tahltan Nation on the five mining leases under the IBCA;
- A 1% NSR payable to Royal Gold on all or portions of four of the mining leases.

22.3.7 Working Capital

The cash flow model includes an allowance of 15 days for accounts receivable and 45 days for accounts payable.

22.3.8 Taxes

Federal income tax is levied at a rate of 15% on taxable income and provincial income tax in BC is levied at a rate of 12%, resulting in a combined tax rate of 27%.

Table 22-1: LOM Capital Cost Estimate

Item	Unit	Total
<i>Sustaining</i>		
Open pit mining	C\$ M real	97
Underground mining	C\$ M real	284
TIA	C\$ M real	1,031
Processing	C\$ M real	232
Infrastructure/other	C\$ M real	117
<i>Sustaining Total</i>	<i>C\$ M real</i>	<i>1,761</i>
<i>Non-sustaining</i>		
Block cave expansion	C\$ M real	2,758
<i>Non-Sustaining Total</i>	<i>C\$ M real</i>	<i>2,758</i>
<i>Production stripping</i>		
<i>Production stripping Total</i>	<i>C\$ M real</i>	<i>372</i>
<i>Exploration</i>		
<i>Exploration Total</i>	<i>C\$ M real</i>	<i>99</i>
<i>Total Capital</i>		
Total	C\$ M real	4,991

Note: Numbers have been rounded. Totals may not sum due to rounding.

Table 22-2: LOM Operating Cost Estimate

Item	Unit	Total
Open pit mining cost ex-pit	(C\$/t mined)	3.47
Underground mining cost	(C\$/t ore mined)	5.61
Ore treatment	(C\$/t ore milled)	10.08
General/administration	(C\$/t ore milled)	4.33
Site costs	(C\$/t ore milled)	21.01

A mineral tax is payable in BC:

- 2% net current proceeds tax, which serves as a minimum tax on the net current proceeds of a mining operator (the net current proceeds of an operator is the amount by which the operator's gross revenue from the mine exceeds the current operating costs (excluding capital costs)). The net current proceeds tax is accumulated in a Cumulative Tax Credit Account that is uplifted with an interest component (currently approximately 0.63% per annum);

- 13% net revenue tax, which applies once payback of the cumulative operating and capital costs has been achieved (the net revenue of an operator is the amount by which the total of the operator's gross revenue for the year (plus government grants, subsidies, and other assistance receivable in the year, and the proceeds from the disposition of capital assets receivable in the year), exceeds the cumulative amount of operating and capital expenditures and certain investment allowances that allow the cumulative expenditure balance to be uplifted (current uplift rate of approximately 0.63% per annum)).

Provincial sales tax is a non-refundable sales tax payable at a rate of 7% on the purchase of goods or services for use in BC. However, an exemption is available for production machinery and equipment used in the exploration of minerals or the development of mines, or equipment primarily used at the qualifying part of a mine site for the extraction or processing of qualifying minerals.

22.3.9 Closure Costs and Salvage Value

No salvage value was allocated.

Mine closure costs are based on an estimated total closure cost for the operation consisting of an annual spend during operations and a final closure cost incurred over a period of 15 years, starting after the final year of production. This cost is included in operating costs. The closure costs are estimated at C\$181 M.

22.3.10 Financing

The base case economic analysis assumes 100% equity financing and is reported on a 100% project ownership basis. Newcrest holds a 70% interest in the Red Chris Operations, and Imperial holds the remaining 30% interest.

22.3.11 Inflation

The base case economic analysis assumes constant prices.

A 2.00% Canadian dollar inflation rate was used for tax calculations in nominal terms.

Capital and operating costs are based on Q2 2021 Canadian dollars.

22.4 Financial Analysis

The economic analysis shows a net present value at 4.5% of C\$2,242 M, and an internal rate of return of 16.1%. A payback period of 3.2 years is based on the earliest date that net accumulated free cash flow is equal to zero. This is calculated from first commercial production that is defined as the date of achieving critical hydraulic radius for the Red Chris block cave, which is assumed to be FY27. All metrics are presented prior to shareholder loans.

Table 22-3 presents the financial metrics for the Red Chris Operations. Table 22-4 to Table 22-8 provide the cashflow for the LOM on an annualized basis. Figure 22-1 shows the free cashflow.

Table 22-3: Project Financial Metrics

Scenario	Unit	LOM Total
NPV	C\$m real	2,242
IRR	%	16.1
Payback (from 30 June 2021)	Years	8.9
Undiscounted cumulative cashflow	C\$m real	5,016
Mine life	Years	36
Open pit mined (ore + waste)	Mt	200
Underground mined	Mt	406
Tonnes moved	Mt	654
Tonnes milled	Mt	471
Gold grade	g/t	0.53
Copper grade	%	0.45
Gold production	koz	5,321
Copper production	kt	1,749
AISC	C\$/oz	(60)
AIC	C\$/oz	458
Site costs	C\$/t milled	21.01
Sustaining capital cost estimate	C\$m real	1,761
Production stripping	C\$m real	372
Exploration	C\$m real	99
Non-sustaining capital cost estimate	C\$m real	2,758
Total capital cost estimate	C\$m real	4,991

Notes: AISC = all-in sustaining capital costs; AIC = all-in costs. All numbers have been rounded. Totals may not sum due to rounding.

Table 22-4: Cash Flow Analysis on an Annualised Basis (Year 2022 to Year 2030)

	Unit	LOM Summary/ Average	2022	2023	2024	2025	2026	2027	2028	2029	2030
<i>Economic Parameters</i>											
Gold price	US\$/oz		1,750	1,700	1,550	1,500	1,500	1,500	1,500	1,500	1,500
Copper price	US\$/lb		3.75	3.50	3.30	3.30	3.30	3.30	3.30	3.30	3.30
C\$ exchange rate	C\$/US\$		0.80	0.80	0.80	0.80	0.80	0.80	0.80	0.80	0.80
<i>Operating Summary</i>											
Total material moved	Mt	654.4	44.4	44.1	45.4	43.9	44.0	15.7	15.5	13.5	13.6
Ore processed	Mt	471.1	10.4	10.9	11.0	11.0	10.7	12.3	13.0	13.5	13.6
Gold grade - milled	g/t	0.53	0.37	0.29	0.30	0.51	0.61	0.41	0.67	0.89	1.03
Copper grade	%	0.45	0.41	0.36	0.44	0.57	0.59	0.36	0.48	0.60	0.69
<i>Metal Production</i>											
Gold production	koz	5,321	63	50	52	98	123	99	200	289	340
Copper production	kt	1,749	34	32	39	51	52	33	51	68	80
Gold eq. production	koz	13,785	223	194	236	344	378	260	446	617	727
AISC	A\$/oz	(60)	3,985	3,624	2,101	(145)	(24)	538	43	(518)	(740)
<i>Financial Summary</i>											
Revenues (net of TC/RC)	C\$M	23,925	448	376	416	589	647	447	771	1,077	1,270
[-] Transportation costs	C\$M	1,192	27	22	27	35	37	24	37	42	49
[-] Royalties	C\$M	443	5	4	5	11	10	12	18	23	26
[-] Site operating costs	C\$M	9,900	301	292	291	289	308	198	249	264	269
[+] Production stripping	C\$M	372	123	72	68	65	44	—	—	—	—
[-] Ore inventory adjustment	C\$M	(12)	4	0	(9)	(26)	(12)	21	9	1	—
EBITDA	C\$M	12,774	235	129	171	346	349	193	458	748	927
[-] Non-cash adjustments to EBITDA	C\$M	12	(4)	(0)	9	26	12	(21)	(9)	(1)	—
[-] Cash payments for tax	C\$M	2,519	7	4	5	8	8	4	10	15	107

	Unit	LOM Summary/ Average	2022	2023	2024	2025	2026	2027	2028	2029	2030
[-] Δ Net working capital	C\$M	(55)	0	11	5	4	(23)	(30)	(16)	(19)	(9)
[-] Rehabilitation payments	C\$M	181	—	—	—	—	—	—	—	—	—
Operating cash flow	C\$M	10,007	232	135	162	315	305	180	442	714	811
[-] Non-sustaining capital	C\$M	2,758	201	356	417	515	338	152	40	—	—
[-] Production stripping	C\$M	372	123	72	68	65	44	—	—	—	—
[-] Sustaining capital	C\$M	1,761	188	121	101	73	61	51	82	48	29
[-] Exploration	C\$M	99	29	2	2	2	2	2	2	2	2
Free Cash Flow	C\$M	5,016	(309)	(415)	(427)	(341)	(140)	(26)	318	665	779

Table 22-5: Cash Flow Analysis on an Annualised Basis (Year 2031 to Year 2040)

	Unit	2031	2032	2033	2034	2035	2036	2037	2038	2039	2040
Economic Parameters											
Gold price	US\$/oz	1,500	1,500	1,500	1,500	1,500	1,500	1,500	1,500	1,500	1,500
Copper price	US\$/lb	3.30	3.30	3.30	3.30	3.30	3.30	3.30	3.30	3.30	3.30
C\$ exchange rate	C\$/US\$	0.80	0.80	0.80	0.80	0.80	0.80	0.80	0.80	0.80	0.80
Operating Summary											
Total material moved	Mt	13.6	13.6	13.6	13.6	13.6	14.9	16.7	13.6	13.6	13.6
Ore processed	Mt	13.6	13.6	13.6	13.6	13.6	13.6	13.6	13.6	13.6	13.6
Gold grade - milled	g/t	1.12	1.12	0.95	0.77	0.66	0.54	0.46	0.42	0.38	0.35
Copper grade	%	0.75	0.74	0.68	0.62	0.57	0.52	0.46	0.43	0.39	0.36
Metal Production											
Gold production	koz	368	364	299	236	196	157	132	120	108	98
Copper production	kt	87	86	78	70	65	58	51	48	43	40
Gold eq. production	koz	788	782	679	577	512	440	382	352	317	290
AISC	A\$/oz	(822)	(807)	(841)	(818)	(589)	(516)	(279)	(190)	69	387
Financial Summary											

	Unit	2031	2032	2033	2034	2035	2036	2037	2038	2039	2040
Revenues (net of TC/RC)	C\$M	1,376	1,366	1,184	1,002	886	758	655	604	544	498
[-] Transportation costs	C\$M	53	53	48	45	42	39	36	34	30	28
[-] Royalties	C\$M	27	25	21	18	16	14	12	11	10	9
[-] Site operating costs	C\$M	265	265	265	265	264	273	281	271	272	271
[+] Production stripping	C\$M	—	—	—	—	—	—	—	—	—	—
[-] Ore inventory adjustment	C\$M	(0)	0	(0)	0	0	—	—	(0)	(0)	(0)
EBITDA	C\$M	1,031	1,023	850	674	564	433	326	289	232	189
[-] Non-cash adjustments to EBITDA	C\$M	0	(0)	0	(0)	(0)	—	—	0	0	0
[-] Cash payments for tax	C\$M	195	261	257	206	165	108	71	71	59	38
[-] Δ Net working capital	C\$M	(5)	1	6	7	13	13	2	(8)	(1)	9
[-] Rehabilitation payments	C\$M	—	—	—	—	—	—	—	—	—	—
Operating cash flow	C\$M	831	763	599	475	412	338	257	210	172	160
[-] Non-sustaining capital	C\$M	—	—	—	—	29	107	98	26	2	51
[-] Production stripping	C\$M	—	—	—	—	—	—	—	—	—	—
[-] Sustaining capital	C\$M	30	39	29	30	72	50	33	32	29	36
[-] Exploration	C\$M	2	2	2	2	2	2	2	2	2	2
Free Cash Flow	C\$M	799	723	568	443	310	180	124	150	139	71

Table 22-6: Cash Flow Analysis on an Annualised Basis (Year 2041 to Year 2050)

	Unit	2041	2042	2043	2044	2045	2046	2047	2048	2049	2050
<i>Economic Parameters</i>											
Gold price	US\$/oz	1,500	1,500	1,500	1,500	1,500	1,500	1,500	1,500	1,500	1,500
Copper price	US\$/lb	3.30	3.30	3.30	3.30	3.30	3.30	3.30	3.30	3.30	3.30
C\$ exchange rate	C\$/US\$	0.80	0.80	0.80	0.80	0.80	0.80	0.80	0.80	0.80	0.80
<i>Operating Summary</i>											
Total material moved	Mt	14.4	17.0	14.7	13.6	13.6	13.6	13.6	13.6	13.6	13.6
Ore processed	Mt	13.6	13.6	13.6	13.6	13.6	13.6	13.6	13.6	13.6	13.6
Gold grade - milled	g/t	0.33	0.32	0.33	0.39	0.41	0.41	0.39	0.43	0.47	0.55
Copper grade	%	0.35	0.33	0.33	0.35	0.35	0.35	0.33	0.38	0.41	0.43
<i>Metal Production</i>											
Gold production	koz	93	92	94	110	115	114	104	117	132	156
Copper production	kt	38	36	36	39	39	38	36	41	46	48
Gold eq. production	koz	277	265	267	298	302	299	277	318	354	391
AISC	A\$/oz	671	899	784	419	534	561	848	328	32	(29)
<i>Financial Summary</i>											
Revenues (net of TC/RC)	C\$M	475	455	459	513	520	514	476	546	609	673
[-] Transportation costs	C\$M	27	25	25	28	27	27	25	29	33	35
[-] Royalties	C\$M	9	9	9	10	10	9	10	11	12	13
[-] Site operating costs	C\$M	278	295	285	278	279	279	278	278	280	280
[+] Production stripping	C\$M	—	—	—	—	—	—	—	—	—	—
[-] Ore inventory adjustment	C\$M	0	0	(0)	(0)	(0)	0	0	—	—	(0)
EBITDA	C\$M	161	126	139	197	204	198	163	227	284	346
[-] Non-cash adjustments to EBITDA	C\$M	(0)	(0)	0	0	0	(0)	(0)	—	—	0
[-] Cash payments for tax	C\$M	14	3	8	28	44	48	38	64	87	111
[-] Δ Net working capital	C\$M	16	(2)	(5)	(4)	(4)	(2)	3	(3)	(3)	(1)
[-] Rehabilitation payments	C\$M	—	—	—	—	—	—	—	—	—	—
Operating cash flow	C\$M	163	121	127	165	156	147	128	160	194	234

	Unit	2041	2042	2043	2044	2045	2046	2047	2048	2049	2050
[-] Non-sustaining capital	C\$M	157	108	75	65	21	—	—	—	—	—
[-] Production stripping	C\$M	—	—	—	—	—	—	—	—	—	—
[-] Sustaining capital	C\$M	42	29	29	29	42	41	49	40	34	41
[-] Exploration	C\$M	2	2	2	2	2	2	2	2	2	2
Free Cash Flow	C\$M	(38)	(18)	20	69	91	104	77	118	158	191

Table 22-7: Cash Flow Analysis on an Annualised Basis (Year 2051 to Year 2060)

	Unit	2051	2052	2053	2054	2055	2056	2057	2058	2059	2060
Economic Parameters											
Gold price	US\$/oz	1,500	1,500	1,500	1,500	1,500	1,500	1,500	1,500	1,500	1,500
Copper price	US\$/lb	3.30	3.30	3.30	3.30	3.30	3.30	3.30	3.30	3.30	3.30
C\$ exchange rate	C\$/US\$	0.80	0.80	0.80	0.80	0.80	0.80	0.80	0.80	0.80	0.80
Operating Summary											
Total material moved	Mt	13.6	13.6	13.6	13.6	13.6	13.6	11.2	—	—	—
Ore processed	Mt	13.6	13.6	13.6	13.6	13.6	13.6	11.2	—	—	—
Gold grade - milled	g/t	0.57	0.54	0.49	0.44	0.39	0.33	0.31	—	—	—
Copper grade	%	0.43	0.42	0.40	0.39	0.37	0.33	0.32	—	—	—
Metal Production											
Gold production	koz	161	147	130	116	102	83	60	—	—	—
Copper production	kt	48	46	44	43	41	36	29	—	—	—
Gold eq. production	koz	395	372	344	323	300	260	200	—	—	—
AISC	A\$/oz	(37)	93	141	176	311	676	1,453	—	—	—
Financial Summary											
Revenues (net of TC/RC)	C\$M	682	640	592	555	515	445	342	—	—	—
[-] Transportation costs	C\$M	35	33	31	30	29	26	20	—	—	—
[-] Royalties	C\$M	13	12	11	10	9	7	3	—	—	—
[-] Site operating costs	C\$M	280	280	280	280	278	276	264	—	—	—

	Unit	2051	2052	2053	2054	2055	2056	2057	2058	2059	2060
[+] Production stripping	C\$M	—	—	—	—	—	—	—	—	—	—
[-] Ore inventory adjustment	C\$M	(0)	—	(0)	(0)	0	0	0	—	—	—
EBITDA	C\$M	355	316	270	235	198	136	54	—	—	—
[-] Non-cash adjustments to EBITDA	C\$M	0	—	0	0	(0)	(0)	(0)	—	—	—
[-] Cash payments for tax	C\$M	115	100	84	72	59	38	7	—	—	—
[-] Δ Net working capital	C\$M	(0)	3	1	1	2	2	(18)	(2)	(1)	—
[-] Rehabilitation payments	C\$M	—	—	—	—	—	—	—	1	80	43
Operating cash flow	C\$M	240	219	187	163	141	101	30	(3)	(81)	(43)
[-] Non-sustaining capital	C\$M	—	—	—	—	—	—	—	—	—	—
[-] Production stripping	C\$M	—	—	—	—	—	—	—	—	—	—
[-] Sustaining capital	C\$M	40	47	38	32	33	30	23	7	3	—
[-] Exploration	C\$M	2	2	2	2	2	2	2	—	—	—
Free Cash Flow	C\$M	198	170	147	130	106	69	5	(10)	(83)	(43)

Table 22-8: Cash Flow Analysis on an Annualised Basis (Year 2061 to Year 2066)

	Unit	2061	2062	2063	2064	2065	2066
Economic Parameters							
Gold price	US\$/oz	1,500	1,500	1,500	1,500	1,500	1,500
Copper price	US\$/lb	3.30	3.30	3.30	3.30	3.30	3.30
C\$ exchange rate	C\$/US\$	0.80	0.80	0.80	0.80	0.80	0.80
Operating Summary							
Total material moved	Mt	—	—	—	—	—	—
Ore processed	Mt	—	—	—	—	—	—
Gold grade - milled	g/t	—	—	—	—	—	—
Copper grade	%	—	—	—	—	—	—
Metal Production							
Gold production	koz	—	—	—	—	—	—

	Unit	2061	2062	2063	2064	2065	2066
Copper production	kt	—	—	—	—	—	—
Gold eq. production	koz	—	—	—	—	—	—
AISC	A\$/oz	—	—	—	—	—	—
Financial Summary							
Revenues (net of TC/RC)	C\$M	—	—	—	—	—	—
[-] Transportation costs	C\$M	—	—	—	—	—	—
[-] Royalties	C\$M	—	—	—	—	—	—
[-] Site operating costs	C\$M	—	—	—	—	—	—
[+] Production stripping	C\$M	—	—	—	—	—	—
[-] Ore inventory adjustment	C\$M	—	—	—	—	—	—
EBITDA	C\$M	—	—	—	—	—	—
[-] Non-cash adjustments to EBITDA	C\$M	—	—	—	—	—	—
[-] Cash payments for tax	C\$M	—	—	—	—	—	—
[-] Δ Net working capital	C\$M	—	—	—	—	—	—
[-] Rehabilitation payments	C\$M	33	15	1	1	1	1
Operating cash flow	C\$M	(33)	(15)	(1)	(1)	(1)	(1)
[-] Non-sustaining capital	C\$M	—	—	—	—	—	—
[-] Production stripping	C\$M	—	—	—	—	—	—
[-] Sustaining capital	C\$M	—	—	—	—	—	—
[-] Exploration	C\$M	—	—	—	—	—	—
Free Cash Flow	C\$M	(33)	(15)	(1)	(1)	(1)	(1)

Notes: AISC = all-in sustaining capital costs; TC/RC = treatment charges/refining charges; EBITDA = earnings before interest, taxes, depreciation and amortization. All numbers have been rounded. Totals may not sum due to rounding.

Figure 22-1: Free Cash Flow

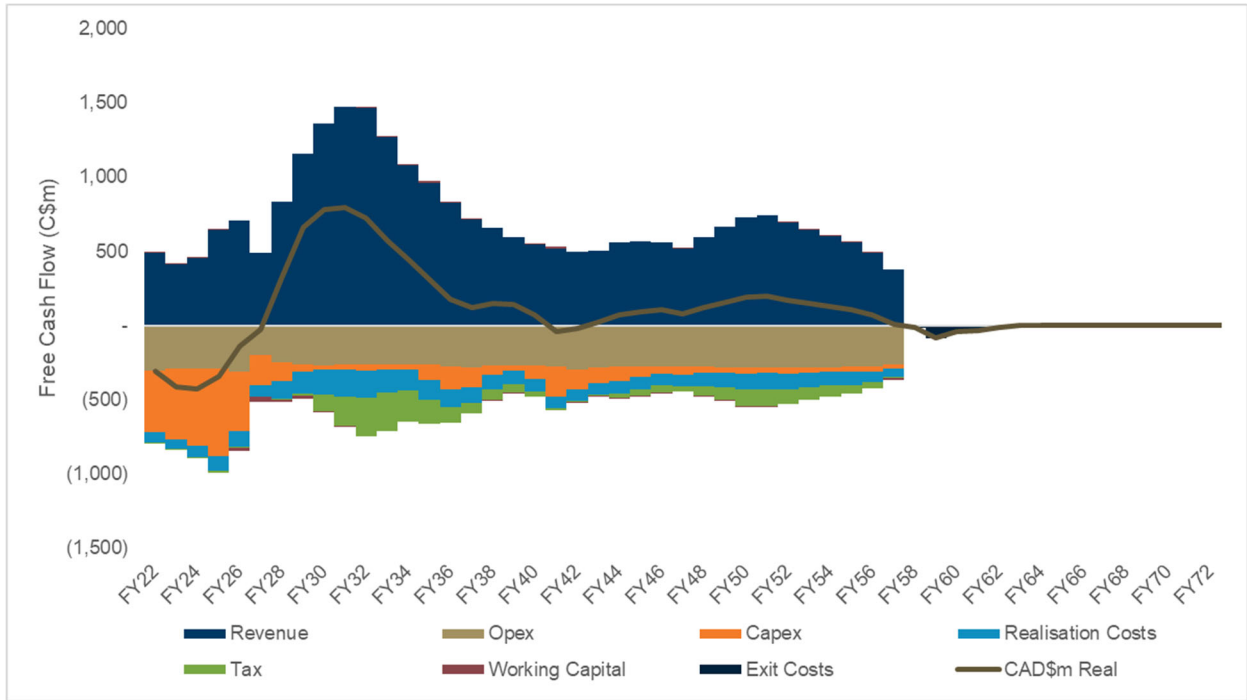

Note: Figure prepared by Newcrest, 2021.

22.5 Sensitivity Analysis

A deterministic point-estimate sensitivity analysis was conducted on each of the key project variables and value drivers. The sensitivity analysis reflects the changes in IRR (%) and NPV (C\$ M) for the corresponding individual movement in each factor.

Figure 22-2 and Figure 22-3 present sensitivity analyses using IRR and NPV metrics, respectively.

The Red Chris Operations, including the proposed block cave, are most sensitive to changes in the copper price, less sensitive to changes in the gold price, copper grade, capital costs, gold grade, foreign exchange, gold recovery, copper recovery and least sensitive to changes in operating costs.

Figure 22-2: Sensitivity Analysis, IRR

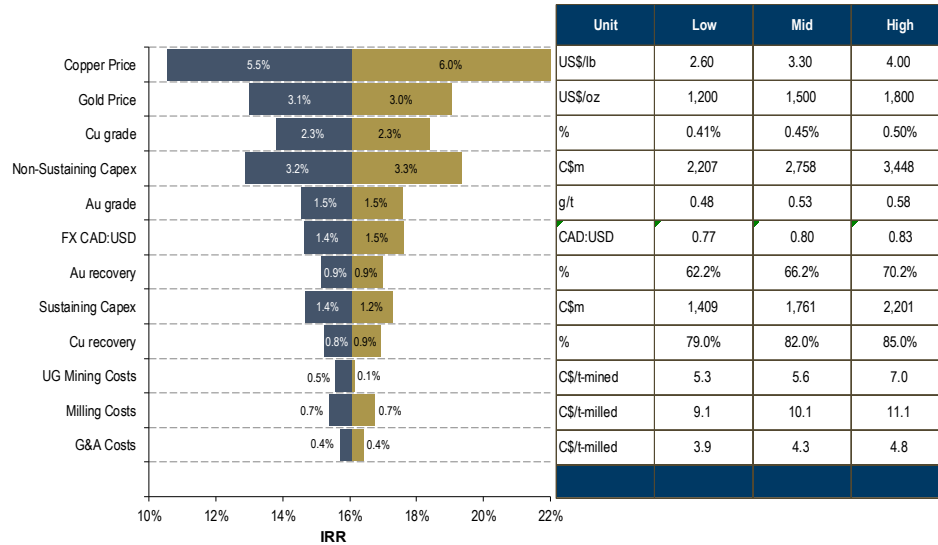

Note: Figure prepared by Newcrest, 2021

Figure 22-3: Sensitivity Analysis, NPV

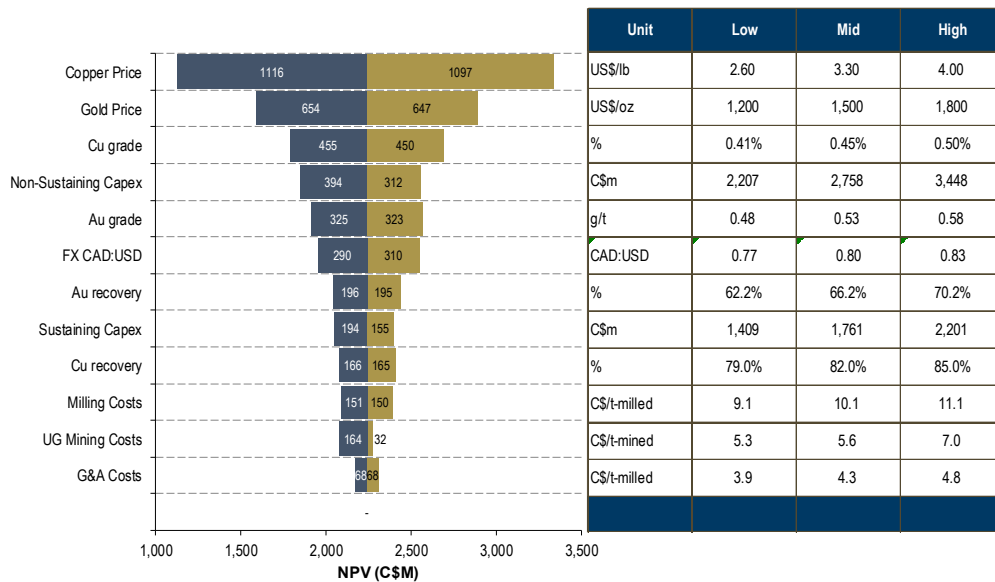

Note: Figure prepared by Newcrest, 2021

22.6 QP Comments on “Item 22: Economic Analysis”

The QP notes:

- The economic analysis is presented on a 100% basis. Newcrest holds a 70% interest in the Red Chris Operations;
- The LOM IRR for Red Chris is forecast to be 16.1%, and the projected LOM NPV is US\$2,242 M. The payback period is estimated at eight years and 11 months;
- The Red Chris Operations, including the proposed block cave, is most sensitive to changes in the copper price, less sensitive to changes in the gold price, copper grade, capital costs, gold grade, foreign exchange, gold recovery, copper recovery and least sensitive to changes in operating costs.

23 ADJACENT PROPERTIES

This section is not relevant to this Report.

24 OTHER RELEVANT DATA AND INFORMATION

This section is not relevant to this Report.

25 INTERPRETATION AND CONCLUSIONS

25.1 Introduction

The QPs note the following interpretations and conclusions in their respective areas of expertise, based on the review of data available for this Report.

25.2 Mineral Tenure, Surface Rights, Water Rights, Royalties and Agreements

Information from legal experts and Newcrest's in-house experts support that the tenure held is valid and sufficient to support a declaration of Mineral Resources and Mineral Reserves.

The Project is 70% owned by Newcrest Red Chris Mining Limited, a Newcrest subsidiary, and 30% owned by Red Chris Development Company Ltd., an Imperial subsidiary. The operating entity is the unincorporated Newcrest Red Chris Joint Venture. Newcrest is operator.

The main tenures for purposes of the LOM plan are five mining leases issued on 20 June 2012, for a term of 30 years, with an expiry date of 20 June 2042.

All land in the immediate vicinity of the Red Chris Operations is Crown land.

Applications for groundwater licences under the Water Sustainability Act were submitted and are under review by the FLNRORD for new and existing groundwater use for 'Mining Use'.

Royalties are payable to the Tahltan Nation and Royal Gold on all or a portion of the mining leases. Annual advance royalty payments to the Tahltan Nation commenced in October 2016.

Current environmental liabilities are in line with those to be expected from a long-life mining operation where mining activities are conducted via open pit mining methods. These include the open pit, operations infrastructure, and access roads.

To the extent known to the QP, there are no other significant factors and risks known to Newcrest that may affect access, title, or the right or ability to perform work on the Project that are not discussed in this Report.

25.3 Geology and Mineralization

The mineralization discovered to date in the Project area is considered by Newcrest to be representative of porphyry copper–gold systems.

The understanding of the Red Chris deposit setting, lithologies, and geological, structural, and alteration controls on mineralisation is sufficient to support estimation of Mineral Resources and Mineral Reserves.

The mineralisation style and setting are well understood and can support declaration of Mineral Resources and Mineral Reserves.

A number of areas remain prospective at depth in the immediate vicinity of the open pit operation.

25.4 Exploration, Drilling and Analytical Data Collection in Support of Mineral Resource Estimation

The exploration programs completed by Texasgulf, American Bullion, bcMetals, Imperial, and Newcrest are appropriate for the style of the deposits in the Project area.

Sampling methods are acceptable for Mineral Resource estimation.

Sample preparation, analysis and security are generally performed in accordance with exploration best practices and industry standards.

The quantity and quality of the lithological, geotechnical, collar and down-hole survey data collected during the Texasgulf, American Bullion, bcMetals, Imperial and Newcrest exploration and delineation drilling programs are sufficient to support Mineral Resource estimation.

No material factors were identified with the data collection from the drill programs that could significantly affect Mineral Resource estimation.

Sample preparation, analysis, and security practices and results for the Imperial and Newcrest programs are acceptable, meet industry-standard practice, and are adequate to support Mineral Resource estimation. The collected sample data adequately reflect deposit dimensions, true widths of mineralisation, and the style of the deposits. Sampling is representative of the gold and copper grades.

QA/QC programs for the Imperial and Newcrest campaigns adequately address issues of precision, accuracy and contamination. Drilling programs typically included blanks, duplicates and SRM samples. QA/QC submission rates meet industry-accepted standards. The QA/QC programs did not detect any material sample biases in the data reviewed that supports Mineral Resource estimation.

The data verification programs concluded that the data collected from the Project adequately support the geological interpretations and constitute a database of sufficient quality to support the use of the data in Mineral Resource estimation.

25.5 Metallurgical Testwork

Metallurgical testwork and associated analytical procedures were appropriate to the mineralisation type, appropriate to establish the optimal processing routes, and were performed using samples that are typical of the mineralisation styles found within the open pit and underground sectors of the Red Chris deposit.

Samples selected for testing were representative of the various types and styles of mineralisation. Samples were selected from a range of depths within the deposits. Sufficient samples were taken so that tests were performed on sufficient sample mass.

Underground ore was determined to be significantly harder than open pit ore, therefore, requiring increased power input per tonne of ore treated for a given grind size. There is a general increase in hardness with depth, implying that throughput rates and grind size will be impacted positively over the progression of each macroblock within the block cave design.

Copper and gold head grades were confirmed to be significantly higher than open pit material, especially for macroblock 1. Underground ore was also shown to have a significantly lower pyrite content than open pit ore, which may help moderate water quality risks associated with potential acid generation in the TIA.

Recovery factors estimated are based on appropriate metallurgical testwork, and are appropriate to the mineralisation types and the selected process routes for the Red Chris deposit.

Marketable concentrates can be produced, with some ore zones enriched in secondary copper minerals such as bornite producing elevated concentrate grades. Some samples showed elevated mercury levels in the concentrate, but these were not high enough to cause any significant marketing concerns. Indications are that most underground ores are not expected to produce concentrates that trigger penalty mercury levels. These observations are based on a combination of laboratory testwork results as well as predictions from underground mine plan mercury head grades.

25.6 Mineral Resource Estimates

The Mineral Resource estimation for the Project conforms to industry-accepted practices, and is reported using the 2014 CIM Definition Standards.

There is upside potential for the estimates if mineralisation that is currently classified as Inferred can be upgraded to higher-confidence Mineral Resource categories. Additional upside potential exists if the mineralization currently being drilled out in the East Ridge area can support Mineral Resource estimates.

Factors that may affect the Mineral Resource estimate include changes in local interpretations of mineralization geometry and continuity of mineralized zones; changes to geological and grade shape and geological and grade continuity assumptions; changes to metallurgical recovery assumptions; changes to the input assumptions used to derive the conceptual open pit used to constrain the estimate; changes to the input assumptions for assumed block caving operations; changes to the NSR cut-offs applied to the estimates; variations in geotechnical, hydrogeological and mining assumptions; forecast dilution; and changes to environmental, permitting and social license assumptions.

25.7 Mineral Reserve Estimates

The Mineral Reserve estimation for the Project incorporates industry-accepted practices and meets the requirements of the 2014 CIM Definition Standards.

Mineral Reserves were estimated assuming conventional open pit and conventional block caving methods. Mineral Resources were converted to Mineral Reserves using a detailed mine plan, an engineering analysis, and consideration of appropriate modifying factors. Modifying factors include the consideration of dilution and ore losses, underground mining methods, geotechnical and hydrological considerations, metallurgical recoveries, permitting and infrastructure requirements.

Factors that may affect the Mineral Reserve estimates include changes to long-term gold and copper price assumptions; changes to exchange rate assumptions; changes to metallurgical recovery assumptions; changes to the input assumptions used to design the optimized open pit shell; changes to the input assumptions used to derive the cave outlines and the mine plan that is based on those cave designs; changes to operating and capital assumptions used, including changes to input cost assumptions such as consumables, labour costs, royalty and taxation rates; variations in geotechnical, mining, dilution and processing recovery assumptions; including changes to designs as a result of changes to geotechnical, hydrogeological, and engineering data used; changes to the NSR cut-off criteria used to constrain the open pit estimates; changes to the shut-off criteria used to constrain the underground estimates; changes to the assumed permitting and regulatory environment under which the mine plan was developed; ability to maintain mining permits and/or surface rights; and the ability to maintain social and environmental license to operate.

Factors that are risk-specific to block cave operations, and which may affect the Mineral Reserves include: inrush of water into the underground workings including decline, cave levels and infrastructure areas; poorer rock mass quality and quantity than interpreted; inability to achieve planned decline development rates having impact on schedule and cost; incorrect estimation of cave propagation potentially leading to air blast; and damage to mine workings due to a seismic event.

25.8 Mine Plan

Open pit mining operations are conducted year-round, and the block cave project is assumed to be operational year-round.

The mine plans are based on the current knowledge of geotechnical, hydrological, mining and processing information.

Open pit operations are conducted using conventional methods and a conventional truck and shovel fleet. Underground operations will use conventional block cave underground mining methods and equipment fleets.

The Red Chris East Zone is currently being mined by open pit mining. The open pit mine is due for completion of the final phase (Phase 8) in FY26, producing a total of 63.6 Mt of ore from Q4 FY21 to Q4 FY26. The first cave ore from MB1 (located directly below Phase 8) is scheduled for January 2026 (Q3 FY26), with full production from MB1 in FY30. During the block cave production ramp-up the process plant feed will be supplemented by stockpiled ore.

The proposed block cave sequence will be, in order, MB1, MB2, and MB3. This sequence is based on mining the high-grade portion of the Mineral Reserve first (MB1). MB2 will be a southern extension of MB1, and with cave rules and stress orientation dictating that MB3 is opened from southeast to northwest, MB2 must be opened prior to MB3.

The forecast tonnage profile transitions from a predominantly open pit feed in FY26 to an exclusively underground mill feed in FY30 when the nameplate capacity of 13.6 Mt/a is scheduled to be reached.

25.9 Recovery Plan

The proposed processing methods are conventional to the industry. The comminution and recovery processes are widely used with no significant elements of technological innovation.

The process plant flowsheet designs were based on testwork results, previous study designs and industry-standard practices. The flowsheet is a standard porphyry copper flowsheet employing SAG and ball milling, flotation, regrinding, thickening and filtering to produce a copper concentrate at a moisture content of 8% for export. The plant has been in operation since 2015.

The 2021 PFS metallurgical testwork program confirmed that a flowsheet incorporating crushing, grinding, flotation, and concentrate dewatering was suitable for the planned block cave material.

The Central Case expansion aimed to increase the throughput of the process plant from the current 11.0 Mt/a treating open pit ore to 13.6 Mt/a treating underground ore. The underground ore is harder and has higher copper and gold head grades. In the Central Case the target grind size aimed to revert to the original Red Chris design of 80% passing 150 µm. The Central Case expansion largely keeps the existing process operation and expands some unit operations to suit block cave ore: grinding, rougher flotation, concentrate regrinding, cleaner flotation, and concentrate dewatering. There were modifications to the existing plant that would no longer be required, such as sulphide scavenger flotation. Some existing unit operations would be removed to create space in the existing process plant, this included removal of the existing regrind ball mill. The expansion scenario considered that the ongoing process improvement projects would be online prior to the block cave expansion, including Cleaner Column 3, Phase 1 pre-rougher StackCells (treating cyclone overflow from the existing SABC circuit), and NAG tailings thickening.

The process plant will produce variations in recovery due to the day-to-day changes in ore type or combinations of ore type being processed. These variations are expected to trend to the forecast recovery value for monthly or longer reporting periods.

The plant is designed to cater for the ore composition changes over the LOM, and blending is not expected to be required.

Copper concentrate is assumed to be shipped out of Stewart Bulk Terminals. Concentrate will be transported via trucks from the mine site to the port.

25.10 Infrastructure

Infrastructure required to support open pit mining operations is in place.

The transition to block cave mining and associated changes to processing will be supported by existing infrastructure as well as infrastructure upgrades. Infrastructure upgrades are required in the following areas: new mobile equipment maintenance and workshop facility; pumping upgrade from the North Reclaim dam to the booster station; seepage mitigation modifications for the TIA; new cyclone sand plants and tailings thickener for dewatering NAG tailings cyclone overflow; associated modifications to tailings pipelines for the cyclone sand plants, thickeners, and short-term tailings deposition; dust cover for the coarse ore stockpile; and accommodations camp upgrades.

New infrastructure requirements for the block cave project include: operations accommodation complex, site asset operation centre, mine dry, concrete/shotcrete batch plant; expansion of existing North dam and South dam, new Northeast dam, relocated North Reclaim dam and South Reclaim dam, new Northeast Reclaim dam, North Valley pumping wells, North Valley seepage wells, make-up water booster pumps and pipelines for fresh and reclaim water, potable water treatment plant, fire water supply to operations accommodation complex, decline conveyor; propane, diesel storage and distribution; air compressors to supply compressed air to underground utility stations; sewage treatment plant, septic field; ditches around the operations accommodation complex; expansions to switchgear and substations, mine substation, site-wide reticulation; communications backbone feeding surface and underground facilities; surface haul roads, access to conveyor portal, ventilation raises, process plant, TIA dam access roads; laydown areas, construction offices, warehouse, maintenance shops, water utility supply pump/pipeline from south reclaim pond; and stockpile pads, TIA reclaim dam diversion ditches, Camp Creek diversion, and Beaver Creek diversion.

There will be new haul roads and site roads to allow access to the various locations, including the TIA, conveyor portal area, exploration portal, ventilation pads and reclaim dams at the TIA. Service roads will also be constructed alongside pipelines and diversion ditches.

The current accommodation camp has an approximate 800-person capacity, and an estimated remaining usage life of 10 years. An additional 400–600 beds will be needed to support the construction and development phases of the Project as envisaged in the 2021 PFS.

The TIA is currently permitted for 302 Mt of tailings and to an elevation of 1,180 m. To support the proposed block cave operation, the TIA will be expanded to a capacity of about 550 Mt. The design assumes raises on the north, south and northeast dams above that which is currently permitted, to a final elevation of 1,207 m.

The main source of water for the process plant is reclaim from the main pond at the TIA and, when constructed, will be from the planned thickener and cyclone sand plant. Groundwater pumping from the deep aquifer is the main source of makeup water when needed to meet process water demands.

Power to the Red Chris Operations is provided by BC Hydro via the Northwest Transmission Line. The current contract with BC Hydro sets the authorized demand at 55 MVA at 0.95 power factor or better. The preliminary load list indicates the total site load requirements to support the block cave project will increase from 45 MW to 100 MW. This will require expansions to transformers and switchgear, and a new mine substation.

25.11 Environmental, Permitting and Social Considerations

Baseline and supporting studies were completed in support of current and proposed mine designs, operations, and permitting. The Red Chris Operations have continued to collect comprehensive environmental monitoring data to support effective environmental management.

There is an EMS in place for the open pit operations, which includes associated plans, procedures, policies, guidelines, auditing, and compliance. The EMS and EMPs will be updated to incorporate the block cave project.

A closure plan was developed for the 2021 PFS for the closure of the proposed block cave operation in its entirety, including works associated with the existing open pit operations.

The Red Chris Operations were assessed and approved for open pit mining operations under applicable provincial and federal legislation. The proposed block cave project will require additional permitting, with a staged approach to obtaining permits planned. Permitting for development of the exploration decline is complete and the decline is under construction.

Newcrest will pursue engagement opportunities with the BC government and the Tahltan Central Government in order to gain a clear understanding of the process and scope of the consent and the potential impact on the block cave project.

The mining operations are located entirely within the Tahltan Nation's territory. The proposed block cave project requires an approach that aligns with the Tahltan Nation and leadership and with provincial governments. Since initiating discussions on exploration and Red Chris Operations activities, Newcrest representatives continued to meet regularly with Tahltan Central Government representatives, Tahltan leadership, and the Tahltan Nation. While feedback has been largely positive, a range of concerns and interests have been raised. Newcrest is actively working with Tahltan Central Government representatives, Tahltan leadership, and the Tahltan Nation to address concerns that have been raised.

25.12 Markets and Contracts

The marketing approach is consistent with what is publicly available on industry norms, and the information can be used in mine planning and financial analyses for the Red Chris concentrate in the context of this Report.

The additional concentrate tonnage that will be produced from the block cave project will either be added to existing contracts (those contracts will be expanded) or sold to new smelters customers in Asia or Europe.

At an average LOM concentrate grade of 24.4% Cu, Red Chris concentrate is slightly below premium concentrate grades, but is still expected to attract market interest.

Metal price assumptions were provided by Newcrest management. Newcrest considers analyst and broker price predictions, and price projections used by peers as inputs when preparing the management pricing forecasts.

Contracts are in place in support of the open pit mining and processing operations and include mill consumables, power, explosives, transportation, and camp facilities, and contracts with equipment vendors, drilling contractors, and for concentrate loading and storage.

Contracts that are likely to be concluded in support of the block cave underground project include decline development, pipelines, conveyors, camp construction, port and roads. Major contracts in support of operations are likely to include: accommodations camp management, building maintenance, underground mine infrastructure development, cave establishment, road maintenance, explosives supply, ground support and consumables supply, material transport and logistics to the preferred port site, infrastructure engineering procurement and construction management, labour training, and infrastructure construction.

Current contracts are typically reviewed and negotiated on a frequent basis. Based on Newcrest's knowledge, the contract terms are typical of similar contracts both regionally and nationally. It is expected that future contracts will be awarded and negotiated in a similar manner to contracts that are currently in place.

25.13 Capital Cost Estimates

The capital costs for the open pit operations are considered to be sustaining capital and reported with the operating costs.

The capital cost estimate in the 2021 PFS has a target accuracy of $\pm 25\%$. Capital costs were estimated based on a 13.6 Mt/a Central Case. All inputs were in Q2 2021 Canadian dollars. The capital cost estimate in the 2021 PFS totals C\$2,632 M of which C\$1,729 M is in direct costs (underground mine, materials handling, process plant, on-site infrastructure) and C\$903 in indirect costs (construction support services, project delivery services, and contingency).

25.14 Operating Cost Estimates

Four major line items make up the open pit operating cost estimate: the processing cost; G&A; sustaining capital operating cost; and the mining cost. The estimated LOM open pit cost forecasts are mining cost at US\$2.90/t mined, milling cost at US\$6.70/t milled, G&A costs at US\$3.30/t milled and sustaining capital at US\$3.60/t milled for an overall process cost of US\$13.60/t processed. These values were used to define the open pit mine plan. Values used for the operating cost estimate will not necessarily match those provided in the economic analysis that has validated the mine plan.

The operating cost estimate in the 2021 PFS has a target accuracy of $\pm 25\%$. All inputs were in Q2 2021 Canadian dollars. No escalation was included in the operating cost estimates, nor was a contingency allocation made during estimation. The annual average operating cost estimate for underground ore in the 2021 PFS totals C\$271 M. On a cost per tonne milled basis, mining costs average C\$5.65, process costs average C\$10.36, and site G&A costs average C\$4.33, for a total LOM average cost of C\$20.34.

25.15 Economic Analysis

The financial evaluation is based on a DCF model. The resulting net annual cash flows are discounted back to the date of valuation of start-of-year 30 June 2021. A discount rate of 4.50% was used. Red Chris Operations economics are presented on a 100% basis. Newcrest holds a 70% interest in the Project.

The economic analysis shows a net present value at 4.5% of C\$2,242 M, and an internal rate of return of 16.1%. A payback period of 3.2 years is based on the earliest date that net accumulated free cash flow is equal to zero. This is calculated from first commercial production that is defined as the date of achieving critical hydraulic radius for the Red Chris block cave, which is assumed to be FY27. All metrics are presented prior to shareholder loans.

The Red Chris Operations, including the proposed block cave, are most sensitive to changes in the copper price, less sensitive to changes in the gold price, copper grade, capital costs, gold grade, foreign exchange, gold recovery, copper recovery and least sensitive to changes in operating costs.

25.16 Risks and Opportunities

A number of risk workshops were held during the 2021 PFS and used to define Project risks and opportunities.

25.16.1 Risks

Key risks identified are summarized by discipline area:

- Geology:
 - Lower grades encountered in mining. Potentially mitigate by completing additional drilling campaigns, and performing cave flow modelling;
 - Presence of unidentified faulting. Potentially mitigate by completing a structural geology interpretation; evaluation of available data collection including face mapping and digital scanning;
- Mining:
 - Geotechnical risk associated with potential pit wall failure;
 - Increased costs or reduced grades impacting the end of mine life production;
- Seismicity:
 - A seismic event, either from earthquake or mining-related activity, remobilizes the Kluea lake landslide complex that is located to the south of the open pit. Potentially mitigate by completing mine seismicity modelling and the effect of seismic events on infrastructure and local features; evaluate the impact of block cave induced seismicity on the complex; conduct a structural geology interpretation;
- Water balance and water quality:
 - Uncertainty around operational water balance projection that may impact permitting, design and production. Potentially mitigate using data verification by independent review and de-risk option studies, monitoring, and completion of site-specific remediation and mitigation projects;
 - Wells cannot supply sufficient volume of quality raw water to maintain operation. Although current modelling shows that the capacity of the wells is sufficient to support the block cave project, there is a risk that the modelling completed to date is inaccurate. This could be mitigated by conducting the planned hydrogeological surveys and modelling work; monitoring of water usage requirements; implementing seepage reduction measures; minimizing evaporation losses by reducing the pond size; utilizing thickener to increase water usage efficiency, and apply for additional water extraction permits if needed;
 - Uncertainties as to the long-term water quality (e.g. TIA seepage quality). Potentially mitigate by continuous monitoring, using existing extraction wells, installing new seepage interception system, implementing natural remediation measure and installing a water treatment plant if necessary;

- TIA:
 - TIA failure. Potentially mitigate by retaining a third-party engineer with significant experience in BC and with sand tailings dam experience; establishing additional project/corporate/site interface and alignment on third party oversight requirements, regulatory requirements and IBCA commitments; completing assessment of valley dump geotechnical risk; careful management during construction to ensure dam constructed to design;
 - A seismic event, either from earthquake or mining-related activity, causes a TIA failure. Potentially mitigate by completing mine seismicity modelling and the effect of seismic events on infrastructure and local features; conduct a structural geology interpretation; review designs during next study phase;
 - Required quantities of borrow materials (till, sand and gravel, rockfill) not available to support dam raises (includes North dam, South dam, Northeast dam and reclaim dams). Potentially mitigate by extensive site investigations identifying borrow materials that are of required quality, accessible, and within an economic distance of the TIA dam construction sites. Manage and maintain consistent sand recovery operations from mine ore feed, to process plant, and to tailings cycloning system to ensure that borrow material requirements do not increase;
 - Dam raise assumptions. The 2021 PFS assumes that sufficient inventory of tailings sand will have been accumulated by 2041 to allow for the final embankment raise. This will require the site to achieve the target sand yield at the required quality and quantity. Failure to achieve the yield target would significantly increase embankment construction costs later in the mine life due to the need for additional borrow materials, or alternatively if borrow sources are constrained, may limit the height of the final dams and the associated TIA capacity;
- Closure:
 - There is a risk that closure costs will increase as a result of additional reviews and feasibility study design, resulting from alternative concepts for TIA and RSA covers, water quality controls and post-closure land use;
- Cost estimation:
 - There is a risk that estimates of sustaining capital, non-sustaining capital and operating costs could escalate more than anticipated, due to external economic pressures (e.g. labour shortages in BC, commodity prices, oil, steel, consumables and reagent prices), and/or changes to technical or operational issues underpinning the cost estimates (e.g. water treatments, TIA construction);

- Permitting and contracts:
 - Permitting a block cave operation in BC in the anticipated timeframe. Potentially mitigate by identifying the various government departments and regulations which will govern the approvals process; develop applicable permitting strategies; complete all environmental surveys and supporting studies; engage and consult with Major Mines Office prior to mining proposal submission; identify all potentially interested parties and stakeholders; develop monitoring and mitigation plans;
 - Uncertainties as to assumed timelines to negotiate contracts in support of the planned block cave operations (e.g. contracts deemed to be direct award under the IBCA);
- Human resources:
 - Skilled personnel shortage. Potentially mitigate by monitoring labour market; providing upgraded onsite accommodation; developing strategic partnerships;

25.16.2 Opportunities

Key opportunities are summarized by discipline area:

- Geology:
 - Identification of additional mineralization at higher grades within the known porphyry copper corridor that hosts the Red Chris Operations;
 - Identification of new targets of prospects within the Project area;
- Incorporation of innovative technology in the next study stage:
 - Potential to include state-of-the-art design and technology, such as eccentric rolls crusher, single pass cave establishment, novel cave footprint designs, continuous miner, and autonomous vehicles;
 - Electrification of underground fleet to reduce carbon emissions and improve air quality;
- Use of a dry cover on the TIA to potentially reduce closure costs;
- North dam construction:
 - Once a 300 m or longer beach is established at North dam, as planned, following the relocation of the pump barge to the central location, the dam is no longer considered as a water dam; then the zoned structure can be simplified into a uniform cyclone sand dam similar to the South dam. This change will simplify the construction process and hence increase dam stability, and presents a cost saving;

- Combine NAG/PAG disposal:
 - This opportunity could be realized if the NPR is above 2 after appropriate and practical mixing of NAG and PAG tailings streams and deposited into the pond. Further study is needed to confirm this potential.

25.17 Conclusions

Under the assumptions in this Report, the Red Chris Operations show a positive cash flow over the life-of-mine and supports the Mineral Reserve estimate. The mine plan is achievable under the set of assumptions and parameters used.

26 RECOMMENDATIONS

26.1 Introduction

The QPs prepared a recommended two-phase work program that focuses on a near-mine drill program in the first phase. The second phase consists of work to support feasibility-level studies. The phases are independent and can be completed concurrently.

The cost estimate to complete the first phase of the proposed work is a total of about C\$27.6 M. The suggested budget to complete the second work phase is approximately C\$50.2 M.

26.2 Recommendations Phase 1

No further deposit drilling is recommended in the area of the Mineral Reserves estimate until underground access is available. However, drilling in support of Mineral Resources is suggested. This work phase should consist of a near-mine resource development drilling program with the aim of potentially upgrading resource confidence classifications in the area from the East Ridge to the western extent of MB3. This is assumed to require about 79,000 m of drilling at a total estimated all-in cost of about C\$27.6 M.

26.3 Recommendations Phase 2

Newcrest has approved the feasibility study budget that is summarized in Table 26-1 by key area. Some study aspects have commenced.

The major elements of the planned study are broken out in the following sub-sections.

26.3.1 Geological Modelling

A Mineral Resource estimate update is recommended based on available drill data and, if required by the additional drilling information, an updated geological framework. This modelling exercise has an approximate budget recommended of C\$50,000.

Geometallurgical domain updates should be undertaken based on the additional geometallurgical samples collected during Phase 1, and any resulting updated geological framework. This modelling exercise has an approximate budget of C\$50,000.

Table 26-1: Proposed Feasibility Study Budget

Discipline	Cost (\$C M)
Project management	4.7
Geology, mining and geotechnical	9.8
Metallurgy and processing	6.9
Tailings	1.8
Engineering/infrastructure	7.0
Environment, social and cultural heritage	4.3
Permitting	10.3
Health & safety	0.2
Estimating	0.6
Travel and accommodation	0.8
Contingency	3.6
Total	50.2

Note: Numbers have been rounded. Total may not sum due to rounding.

26.3.2 Mining and Geotechnical Studies

Refinement of the mining and geotechnical aspects is planned as part of the feasibility study. A number of studies are planned, some of which are in progress:

- Validate in situ stress parameters using the ANZI cell method. Budget allocation of approximately C\$600,000;
- Refine the three-dimensional geological and geotechnical models and update rock mass characterizations, focusing on rock types, alteration types, weathering grades, rock quality/strength and major geologic structures. Approximate program cost of C\$800,000;
- Optimize and refine cave footprint, including assessment of variable shut-off grades. Assumed C\$550,000 cost to complete;
- Improve cave monitoring system design using both microseismic and cave beacons. Cost allocation to complete of about C\$100,000;
- Update hydrogeological models and inflow assessments based on updated data from the Phase 1 collection program. Assumed budget of C\$900,000;

- Refine preconditioning assessment and validate fragmentation analysis for the LOM to facilitate optimisation of the material handling and downstream systems. Budget estimate of C\$250,000;
- Complete a hill-of-value style site production rate assessment to identify opportunities to increase rate or optimise value. Estimated budget of C\$150,000;
- Complete detailed engineering and optimisation of the material handling system. Cost estimate of about C\$1.5 M;
- Complete detailed ventilation design and engineering focusing on staged delivery; refine heating options; refine material handling/ventilation interactions. Cost allocation to complete of approximately C\$380,000;
- Optimise the transition between macro blocks both from a design and project value perspective, with a focus on minimising potential production interruptions. Approximate program cost of C\$80,000;
- Evaluate potential to have mine fully electric. Cost estimate of approximately C\$420,000.

26.3.3 Metallurgy and Processing

Feasibility level engineering is planned for the proposed process plant upgrades. Additional work will include geotechnical site investigations in the plant upgrade footprint, a laser scan within the existing mill building to assist with equipment and piping placement and additional metallurgical testwork to better characterize mineralization variation in the underground portion of the Red Chris orebody. The feasibility study budget allocation for this work is approximately C\$6.9 M.

26.3.4 Tailings and Water Management

To support feasibility-level engineering of the dams, reclaim dams and diversion ditch modifications, a geotechnical and hydrogeological site investigation is proposed, together with characterization of future borrow sources. A total of about \$1.8 million was allocated to this work in the feasibility study budget.

26.3.5 Engineering and Infrastructure

Additional work is proposed for the new infrastructure. This will include site investigations for site road upgrades, a new operations accommodation complex and vent raises, assessment of quarry rock for use for concrete aggregate, asset integrity assessment, traffic study, power efficiency studies and investigations to secure additional concentrate storage capacity at Stewart Bulk Terminals. The feasibility study budget allocation is about \$7 M.

26.3.6 Permitting

Continue to assess and advance the understanding of the phased permitting approach to pre-block cave development and block cave mining. This would include further

integration of the block cave development schedule into the permitting process and engagement and consultation with the Tahltan Nation and provincial and federal regulatory agencies. A total of approximately C\$10 M was made in the feasibility study budget.

26.3.7 Environmental, Social and Cultural Heritage

Additional information is planned to be collected in the areas of dust, noise, and air quality to assess the impacts of potential incremental Project increases. Closure studies are also planned to reduce risks associated with long-term water (quantity and quality) and metals leach/acid rock drainage management post-closure, and incorporate input from Tahltan engagement. A budget allocation of about C\$4.3 M was made in the feasibility study budget for this area.

27 REFERENCES

- Base Met Laboratories, 2021: Metallurgical Testing of the Red Chris Deposit – Underground PFS: report prepared for Newcrest, BL0653, February 24, 2021.
- British Columbia Geological Survey, 2018: The Golden Triangle of Northwestern British Columbia: British Columbia Geological Survey, Information Circular 2018-5, 8 p.
- Canadian Institute of Mining, Metallurgy and Petroleum (CIM), 2019: Estimation of Mineral Resources and Mineral Reserves – Best Practice Guidelines, 2019: adopted by CIM Council, November 2019.
- Canadian Institute of Mining, Metallurgy and Petroleum (CIM), 2014: CIM Definition Standards – for Mineral Resources and Mineral Reserves, prepared by the CIM Standing Committee on Reserve Definitions: adopted by the CIM Council, May, 2014.
- Canadian Securities Administrators (CSA), 2011: National Instrument 43-101, Standards of Disclosure for Mineral Projects, Canadian Securities Administrators.
- Collins, J., Colquhoun, W., Giroux, G.H., Nilsson, J.W., and Tenney, D., 2004: Technical Report on the Red Chris Copper-Gold Project, Liard Mining Division: technical report prepared for Red Chris Development Company Ltd. and bcMetals Corporation, effective date 16 December, 2004.
- Fountain, C., 2013: The Whys and Wherefores of Penalty Elements in Copper Concentrates: MetPlant 2013, AusIMM, 15–17 July 2013, Perth, WA.
- Gillstrom, G. and Robertson S., 2010: Red Chris Deposit Technical Report: 2010 Exploration, Drilling and Mineral Resource Update: technical report prepared for Imperial Metals Corporation, effective date 19 May, 2010;
- Gillstrom, G., Anand R. and Robertson S., 2011: 2011 Technical Report on the Red Chris Copper-Gold Project: 2011 Feasibility Study, Exploration, Drilling and Mineral Reserve/Resource Update: technical report prepared for Imperial Metals Corporation and American Bullion Minerals Ltd., effective date 14 March, 2011;
- Gillstrom, G., Anand, R., Robertson, S., and Sterling, P., 2015: 2012 Technical Report on the Red Chris Copper-Gold Project: technical report prepared by Imperial Metals Corporation, effective date 14 February 2012, restated and amended as at 30 September, 2015.
- Giroux, G.H., Rodger, R. and Blanchflower, J.D., 2002: Report on the Red Chris Copper-Gold Project: Report prepared for American Reserve Energy Corporation., 90 pages.
- Giroux, G.H. and Bellamy, J., 2004: Update Report on Red-Chris Copper-Gold Project: report prepared for bcMetals, February 16, 2004.
- Lang, J.R., Stanley, C.R. and Thompson, J.F.H., 1994: Porphyry Copper-Gold Deposits Related to Alkalic Igneous Rocks in the Triassic-Jurassic Arc Terranes of British Columbia: *in* Pierce, F.W., and Bolm, J.G., eds., Porphyry copper deposits of the American Cordillera: Ariz. Geol. Soc. Digest, v. 20, pp. 219–236.
- Newcrest, 2021: Red Chris JV, Block Cave Project, Pre-feasibility Study: report prepared for the Red Chris Joint Venture, 16 vols, October, 2021.

Newell, J. M., 1978: Report on Diamond Drilling on Chris 2 and 4 Mineral Claims, Ealue Lake Area, Liard Mining Division: B.C. Ministry of Energy, Mines and Petroleum Resources, Assessment Report 6872.

Norris, J.R., 2012: Evolution of Alteration and Mineralization at the Red Chris Cu-Au Porphyry Deposit East Zone, Northwestern British Columbia, Canada: M.Sc. thesis, Vancouver, Canada, University of British Columbia, 194 p.

Proffett, J.M., 2009: High Cu Grades in Porphyry Cu Deposits and Their Relationship to Emplacement Depth of Magmatic Sources: *in* *Geology* (August 2009), vol. 37, pp. 675–678.

Rees, C., Riedell, K.B., Proffett, J.M., Macpherson, J., and Robertson, S., 2015: The Red Chris Porphyry Copper-Gold Deposit, Northern British Columbia, Canada: Igneous Phases, Alteration, and Controls of Mineralization: *Economic Geology*, v. 110, pp. 857–888.

Seedorff, E., Dilles, J.H., Proffett, J.M., Einaudi, M.T., Surcher, L., Stavast, W.J.A., Johnson, D.A., and Barton, M.D., 2005: Porphyry Deposits: Characteristics and origin Of Hypogene Features: *Economic Geology* 100th Anniversary Volume, pp. 251–298.

Sillitoe, R.H., 2010: Porphyry Copper Systems: *Economic Geology*, v. 105, p. 3–41.

Singer, D.A., Berger, V.I., and Moring, B.C., 2008: Porphyry Copper Deposits of the World: Database and Grade and Tonnage models: U.S. Geological Survey Open-File Report 2008–1155 (<http://pubs.usgs.gov/of/2008/1155>).

Sinclair, W.D., 2007: Porphyry Deposits: *in* Goodfellow, W.D., ed., *Mineral Deposits of Canada: A Synthesis of Major Deposit-Types, District Metallogeny, the Evolution of Geological Provinces, and Exploration Models*: Geological Association of Canada, Mineral Deposits Division, Special Publication No. 5, p. 223–243.

Smee, B. W., 1995: Report on Analytical Quality, Red Chris Project: internal report prepared for American Bullion Minerals Ltd., 21 p.

Smee, B. W., 1996: Report on Analytical Quality, Red Chris Project: internal report prepared for American Bullion Minerals Ltd., 25 pages and appendices.

Zhu, J-J, Richards, J.P., Rees, C., Creaser, R., DuFrane, S.A., Locock, A., Petrus, J.A., and Lang, J., 2018: Elevated Magmatic Sulphur and Chlorine Contents in Ore-Forming Magmas at the Red Chris Porphyry Cu-Au Deposit, Northern British Columbia, Canada: *Economic Geology*, v. 113, pp. 1,047–1,075.